

GLOSS
HAZE
ORANGE PEEL/DOI
MOTTLING
TRANSPARENCY
SOLID COLOR
PORTABLE COLOR
IN-STORE COLOR
MATCHING
METALLIC COLOR
LIQUID COLOR
LIGHT BOOTHS
ABRASION
ADHESION
APPLICATION
BALANCES
CONDUCTIVITY
DENSITY
DISPERSION
DRYING TIME
FILM THICKNESS
HARDNESS
IMPACT/FLEXIBILITY
MICROSCOPES
SURFACE TENSION
TEMPERATURE
VISCOSITY

2018

QC SOLUTIONS FOR
COATINGS AND PLASTICS

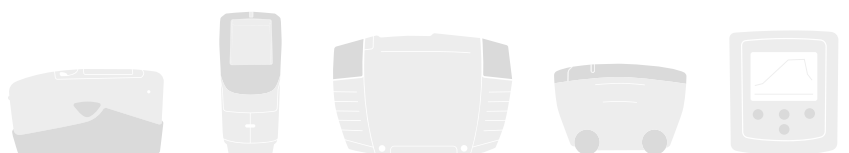



www.byk.com

Contents

Introduction to BYK-Gardner

Company Profile	4 - 5
Always reachable	6 - 7
Continuing Education	8
Repair and Certification Service	9

Appearance

Introduction	11 - 14
Gloss	15 - 30
Haze	31 - 34
Orange Peel/DOI	35 - 53
Mottling	55 - 63
Transparency	67 - 75

Color

Solid Color	77 - 95
In-Store Color Matching	96 - 98
Metallic Color	99 - 125
Liquid Color	127 - 135
Light Booths	137 - 144

Physical Properties

Abrasion	149 - 156
Adhesion	157 - 165
Application	167 - 191
Balances	193 - 197
Conductivity	199
Density	200 - 201
Dispersion	202 - 203
Drying Time	204
Film Thickness	207 - 220
Hardness	221 - 226
Impact/Flexibility	227 - 241
Microscopes	243 - 246
Surface Tension	247
Temperature	249 - 264
Viscosity	265 - 295

Technical Service

Certification Services	297 - 304
Product Index A-Z	305 - 312
Standard Index	313 - 317
Standard Conditions of Sale	319 - 321

BYK-Gardner

The Objective Eye

Since 1924, BYK-Gardner has been the leader in the field of quality control for color, appearance and testing physical material properties.

Today, BYK-Gardner is part of the Altana Group and a direct subsidiary of BYK-Chemie, the worldwide leader of additives for coatings and plastics. Together we offer complete and unique solutions for the paint, coatings and plastic industries:

Additives

to improve the performance of coatings and plastics



Color and appearance instruments

to control consistency and harmony of multi-component products



Physical testing instruments

to set-up standardized sample preparation methods and to control material properties from wet to dry stage.



Quality is our Business

Innovative, reliable and customer-oriented products to objectively control and improve our customers' products and services



State-of-the-art Technologies

The combination of innovative instrument technologies such as LED light sources or high-tech camera detectors with manufacturing excellence make BYK-Gardner products not only outstanding but unique in their performance.



We fully respect and live the Total Quality Management (TQM) principle: our instruments are manufactured and controlled according to international standards DIN EN ISO 9001, ISO/IEC 17025, ISO 14001 guidelines and procedures.



Quality must be measurable

Our commitment to innovation, quality of our products and excellent global service enable our customers to set-up standardized and efficient QC management systems for their complete supply chain. Close customer cooperation in early development stages guarantee testing instruments and software solutions which are customer oriented meeting today's and tomorrow's needs.

You can't manage what you don't measure!

BYK-Gardner

Always reachable

www.byk.com/instruments – Your information source for color, appearance and physical testing needs



Videos to experience BYK-Gardner products live

In our new videos you can meet our instruments in action, learn how to operate the different functions and get a quick overview of the measurement technology.



Essential theory and practical hints

You have direct access to comprehensive information and technical articles about the theoretical background on color, appearance and physical testing methods. You find practical hints on measurement procedures and trouble-shooting examples for any product.



Online shop

In our online shop you can easily search for pricing and place orders for each of the BYK-Gardner instruments and software.



After sales support

If you need repair service or recertification of your instrument you find a listing of all local repair service locations and the type of services offered. You also can download manuals of all BYK-Gardner products.



BYK-Gardner events

You can meet us at trade shows, seminars, trainings and webinars all year round. You're always up to date on our website.

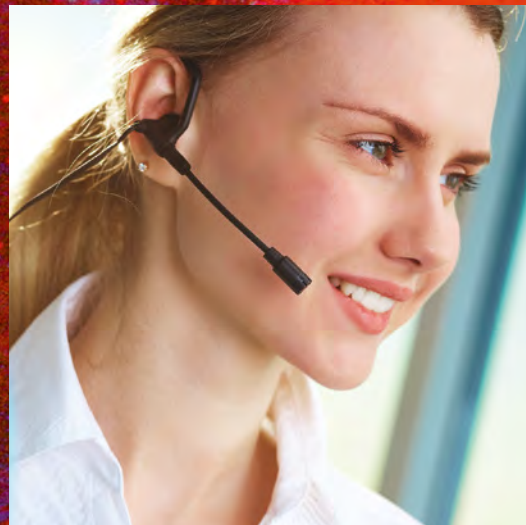

How can we help you?

The basis for our worldwide business is first-class customer service before, during and after sale.



Global Customer Care Center

BYK-Gardner is a truly international company with customer care centers at own subsidiaries and exclusive agents to guarantee local support in every country's native language.

Whether you...

- › need help to select the right product
- › want to know prices or availability
- › want to place an order or track your shipment
- › need professional technical support

...you can easily find the right contact for your country on our web page www.byk.com or just call one of our BYK-Gardner offices.

We are looking forward to answering your questions or to assist you to find the right contact.

BYK-Gardner GmbH
Lausitzer Straße 8
82538 Geretsried
Germany
Tel. 0-800-gardner
(0-800-4273637)
+49-8171-3493-0
Fax. +49-8171-3493-140

BYK-Gardner USA
9104 Guilford Road
Columbia, Maryland 21046
USA
Phone +1-800-343-7721
+1-301-483-6500
Fax +1-800-394-8215
+1-301-483-6555

BYK-Gardner GmbH
Shanghai Representative Office
6A Building A,
Yuehong Plaza, No. 88 Hongcao Road
Shanghai, 200233
P.R. China
Phone +86-21-3367-6331
Fax +86-21-3367-6332

BYK-Gardner

Your Source for Continuing Education

Expand your foundations of knowledge and stay up-to-date on new developments



Global technical support guaranteed

Our technical application specialists are always available to help you with your questions and problems – either over the phone or in person at your facility.

- › Send your samples to our test labs for free testing and recommendation of the best solution for your specific application
- › On-site visit to discuss specific application or seminar to review existing or new measurement needs



BYK-Gardner Color & Appearance Seminars Color and Gloss Measurement in Practice

In a one day seminar you will learn the basic theory of color and gloss measurement combined with practical hands-on workshops. Bring your own samples to the seminar and discuss your specific application with our trained experts.

→ Ideal for beginners and as refresher course.

BYK-Gardner Paint Seminar

Learn how to objectively test physical properties of paint and coatings from wet to dry: Viscosity – Wet Film Application – Temperature Control of Production Ovens – Hardness – Abrasion – Flexibility – Film Thickness ...

→ In one day the theoretical basics, recommendations of international standards will be reviewed with interactive workshops and lot's of hands-on experience.



BYK-Gardner "60 Minutes" – FREE Webinars

If you have limited time webinars are an ideal tool to learn color and appearance as well as testing physical paint properties step-by-step- Every month different topics will be covered for easy digestion.

→ Learning made easy and convenient from your office!

For more information and seminar calendar please refer to www.byk.com/press-events



Repair and Certification Service

One essential component of excellent service is worldwide repair and certification service of standards and instruments. Our local qualified service stations guarantee a quick turn-around time or loaner availability. BYK-Gardner Service Laboratories are accredited in accordance with the recognized ISO/IEC 17025.



Preventive Maintenance Service

In order to keep your instrument in excellent operating condition and enhance your instrument's lifetime, yearly preventive maintenance is recommended including the following services:

- › Cleaning of optics
- › Test of instrument functionality
- › Firmware and Software update
- › Control of measuring instrument with standard set
- › Control of calibration and checking standards
- › Traceable Certificate
- › Calibration sticker on the instrument

At the same time you are ready for DIN EN ISO 9001 or similar audits.

For more information please refer to
www.byk.com/support/instruments/repair-service



Recertification Service for Standards:

Today's Quality Systems all require regular calibration of measurement standards. BYK-Gardner offers checking standards and traceable recertification and calibration services, ensuring accurate measurement worldwide including the following services:

- › As received test data (where appropriate)
- › Comprehensive cleaning of standard
- › Final measurement data using master standards and master instrument
- › Traceable Certificate



Two Years Warranty

We believe in the high quality and reliability of BYK-Gardner products. For this reason we offer **two years** full warranty on all products from the date of purchase.



Effect of Additives on Gloss and Haze

Additives

Additives are substances that are added to a coating in very small amounts to improve properties such as wetting and dispersing, flow and leveling, defoaming or can act as matting agent.

Wetting and dispersing additives

One of the most important steps in the production of pigmented coatings is the homogeneous distribution and stabilization of pigments and fillers within the liquid binder solution. If this step is not optimized, a variety of defects can occur: e.g. flocculation, gloss reduction, color shift and settling. Wetting and dispersing additives are surface-active substances that improve the wetting of solids and prevent the flocculation of the particles.

Two different additives used in a solvent-free coating system are compared with the same system without additive (= control). The new product perfectly stabilizes the pigments resulting in an increased 20° gloss value and a significant reduction in haze.

Matting agents

Dependent on their particle size, wax additives can have an influence on the surface gloss. Usually, particle sizes larger than 1 µm produce a matting effect. CERAFLOUR 1000 is a micronized polymer with wax-like properties to improve surface protection and haptics (soft feel effect). It has a matting effect, especially in radiation curable systems. The graph below shows the influence of additive concentration on the gloss level of a 1-K AC-PU Copolymer Dispersion. Even after 4 week storage at 40 °C the matting effect has not changed.

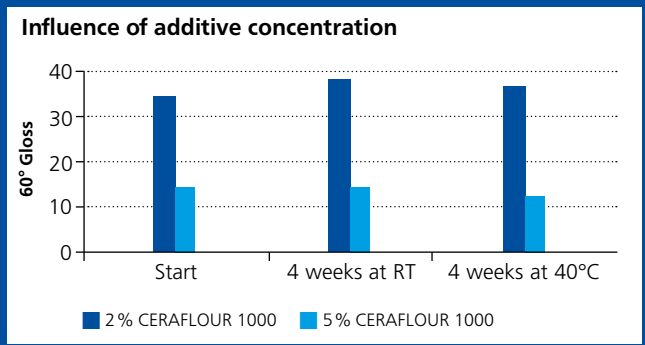
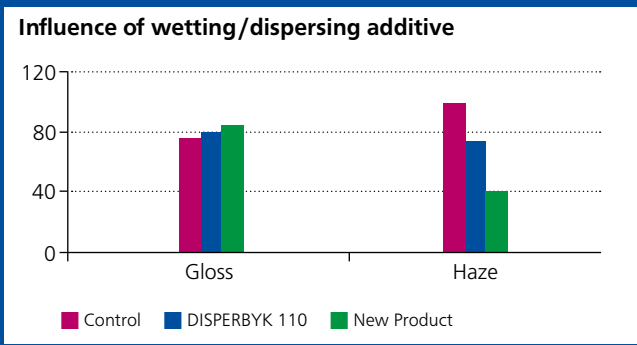

APPEARANCE



APPEARANCE

Appearance

Introduction 13

Gloss

Introduction 15

micro-gloss Family 20°, 60°, 85° 17

micro-TRI-gloss 19

micro-gloss for small parts 20

New! micro-gloss 60° robotic 21

micro-gloss 45° 22

micro-gloss 75° 23

Software smart-chart 24

Gloss accessories for cosmetics 26

Haze

Introduction 31

haze-gloss 33

Orange Peel /DOI

Introduction 35

wave-scan *dual* 39

wave-scan II 43

micro-wave-scan 46

wave-scan ROBOTIC 49

Software smart-process 51

Mottling

Introduction 55

cloud-runner 58

Software smart-process 61

Transparency

Introduction 67

haze-gard i 70



Introduction

Appearance Perception

Uniform appearance is an important quality criterion for many products. Gloss effects are based on the interaction of light with the physical properties of the sample surface. The other influencing component is the physiological evaluation scale.

The human eye is still the best tool to evaluate gloss differences.

However, control by visual analysis is insufficient, because

- evaluation conditions are not clearly defined, and
- people see and judge differently
- In addition, subjective perception of appearance is dependent on personal experience: what is glossy for a paper manufacturer might be dull for an automotive maker.

The following criteria are involved in visual evaluation:

Surface Condition

- Material (eg. coating, plastic, metal)
- Structure (eg. smooth, rough, wavy)

Illumination

Prerequisite for appearance evaluation is direct illumination. Diffuse illumination causes diffuse reflection and decreases the gloss impression.

Observer

Eyesight and mood have a decisive role in the visual judgement. Also, it is important what our eye is focused on.

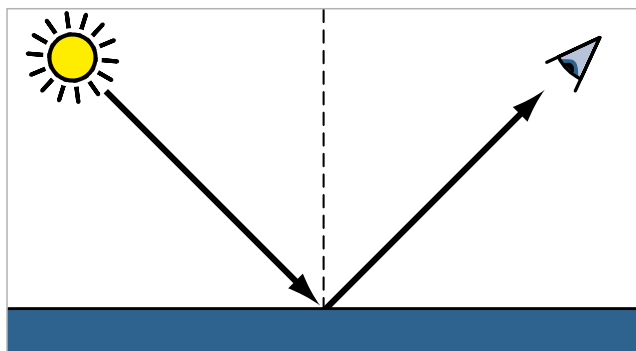

Components of visual evaluation

APPEARANCE

We evaluate a surface by focusing our eye on a reflected image of a light source or on the surface itself. When we focus on the reflected image of a light source, the image forming quality is evaluated – i.e. the capability of a surface to reflect objects. The light source can appear brilliant or dull (gloss). When reflecting an edge the dark area can appear lighter (haze) and the edge can be blurred or distinct (DOI).

Focus on reflected image

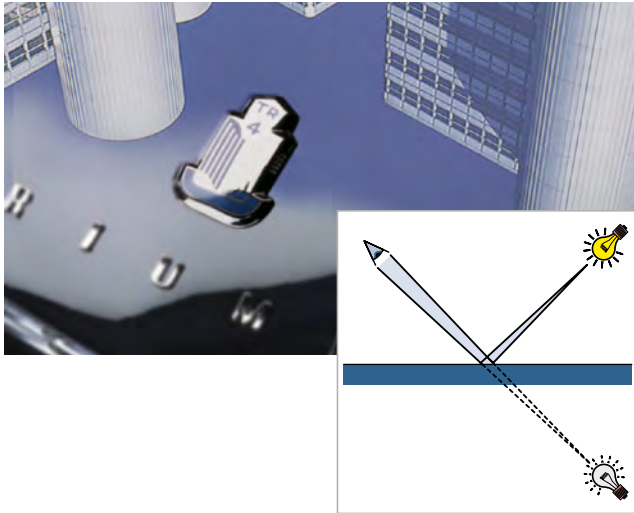

When we focus on the surface, we gain additional information about structure size and form. We see these structures as a wavy pattern of light and dark areas. This waviness is often referred to as orange peel or flow/leveling defects.

Focus on surface



Both evaluation types are individually weighted and contribute to the total appearance perception.

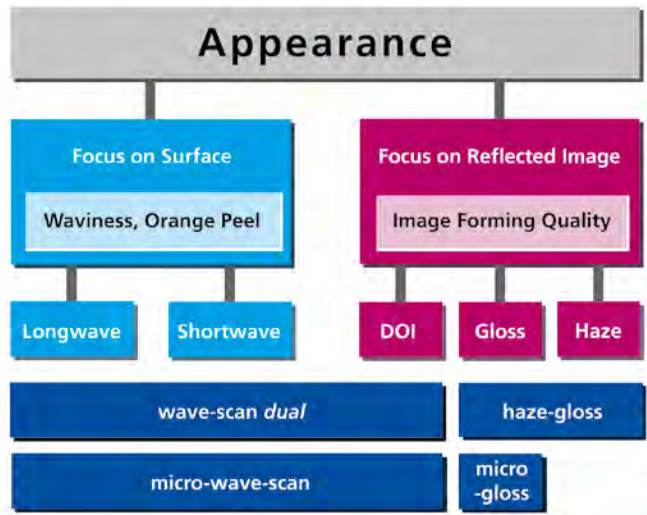

In order to guarantee reliable and practical quality assurance, it is necessary to define appearance with objective, measurable criteria. Accurate characterization of appearance does not only help to control quality, but improves quality and optimizes the manufacturing process.

BYK-Gardner offers a complete system solution to test appearance: from portable instruments such as glossmeters, hazemeters, DOI meters and transparency meters; to benchtop instruments with QC-software.

Introduction

Gloss Measurement

Gloss is a visual impression resulting from surface evaluation. The more direct light is reflected, the more obvious the impression of gloss will be.

High Gloss

Smooth and highly polished surfaces reflect images distinctly. The incident light is directly reflected on the surface, i.e. only in the main direction of reflection. The angle of incidence is equal to the angle of reflection.

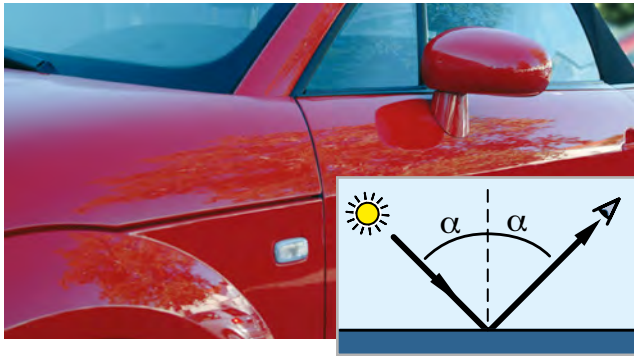

Matte to Semi Gloss

On rough surfaces the light is diffusely scattered in all directions. The image forming qualities are diminished: A reflected object no longer appears brilliant, but blurred. The more uniform the light is scattered, the less intense the reflection in the main direction and the surface will appear duller.

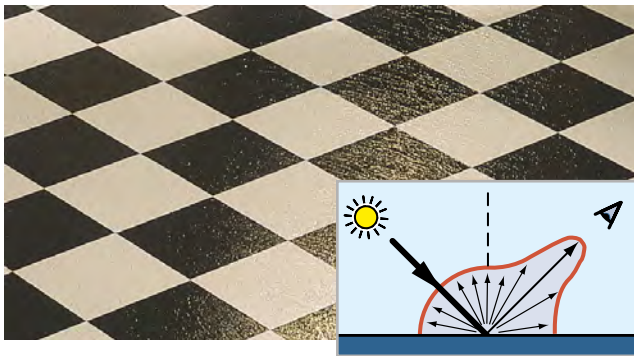

Glossmeter

A glossmeter measures the specular reflection. The light intensity is registered over a small range of the reflection angle.

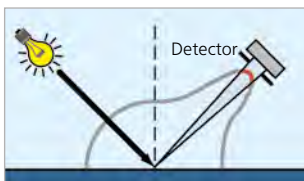

Measurement of specular reflection

GLOSS



The intensity is dependent on the material and the angle of illumination. In case of non-metals (coatings, plastics) the amount of reflected light increases with the increase of the illumination angle. The remaining illuminated light penetrates the material and is absorbed or diffusely scattered dependent on the color. Metals have a much higher reflection and are less angle dependent than non metals.

Example:

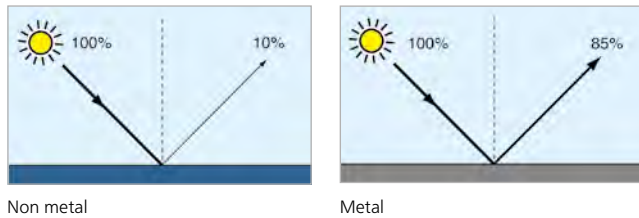

The measurement results of a glossmeter are related to the amount of reflected light from a black glass standard with a defined refractive index, and not to the amount of incident light. The measurement value for this defined standard is equal to 100 gloss units (calibration). Materials with a higher refractive index can have a measurement value above 100 gloss units (GU), e.g. films. In case of transparent materials, the measurement value can be increased due to multiple reflection in the bulk of the material. Due to the high reflection capabilities of metals, values of up to 2000 GU can be reached. For these applications it is common to document the measurement results in % reflection of the illuminated light.

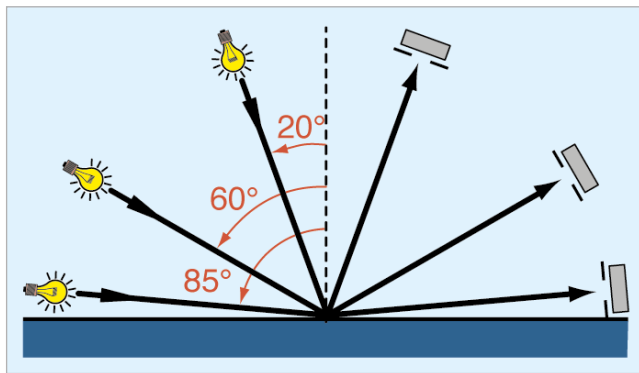

Glossmeters and their handling procedures had to be internationally specified to allow comparison of measurement values. The angle of illumination is of high influence. In order to obtain a clear differentiation over the complete measurement range from high gloss to matte, 3 different geometries, i.e. 3 different ranges, were defined:

Gloss Range	60° value	To be measured with
Semi Gloss	10 to 70	60° geometry
High Gloss	> 70	20° geometry
Low Gloss	< 10	85° geometry

In addition, there are industry specific applications for 45° and 75° measurement geometry.

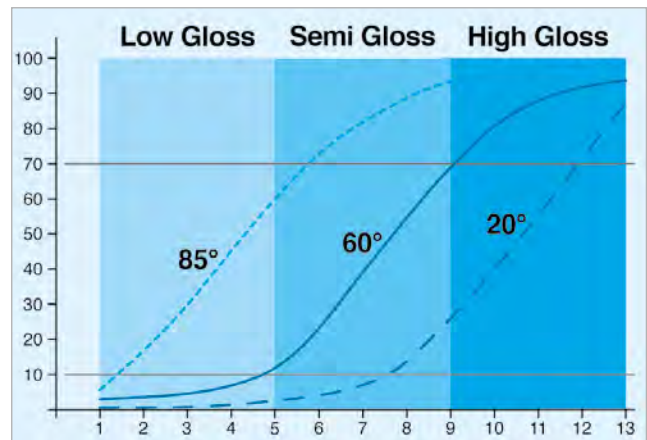

In this case study 13 samples were visually ranked from matte to high gloss and measured with the 3 specified geometries. In the steep slopes of the curves, the differences between the samples can be clearly measured, while in the flat part, the measurement geometry no longer correlates with the visual.

Gloss measurement for any application - whether you are dealing with specific applications or need a universal solution for matte to high gloss samples, BYK-Gardner offers a complete line of glossmeters:

- Reference laboratory instrument - haze-gloss
- Portable micro-gloss family

Their unique features and benefits have made them the industry standard for gloss measurement.

Application	20° Coatings, plastic and related materials			45° Ceramic, Film		75° Paper, Vinyl		
	High Gloss	Semi Gloss	Low Gloss	Semi Gloss		Low Gloss		
ISO 2813	■	■	■					
ASTM D 523	■	■	■					
ASTM D 2457	■	■		■		■		
DIN 67530	■	■	■					
JIS Z 8741	■	■	■	■		■		
ASTM C 346				■				
Tappi T 480						■		
	Brightened Metal							
ISO 7668	■	■	■	■				

micro-gloss

Intelligent gloss measurement with smart communication

The micro-gloss has been the unsurpassed industry standard in gloss measurement for many years. It is the only glossmeter combining the highest accuracy, ease-of-use and multiple functionality – essential for today's testing requirements. In addition, the smart-chart software is the ideal tool for smart communication with professional documentation and efficient data analysis.

Brilliant color display: easy to read – easy to use

Ergonomics and easy handling were the main focus for the design. The micro-gloss is not too large and not too small – it feels just right in your hand. The scroll wheel operation and new color display with an easy-to-navigate menu make gloss measurement easier than ever before.

Auto diagnosis: Standard OK - Calibration OK

Accurate readings require reliable calibration. The gloss meter and calibration holder make a perfect couple – the calibration standard is always protected in the holder of the micro-gloss. The intelligent auto diagnosis of the gloss meter is a unique feature which guarantees long-term calibration stability and tells you when to calibrate. It even checks whether the standard is clean. Operator friendly. Safe.

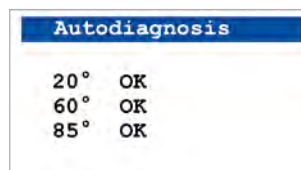
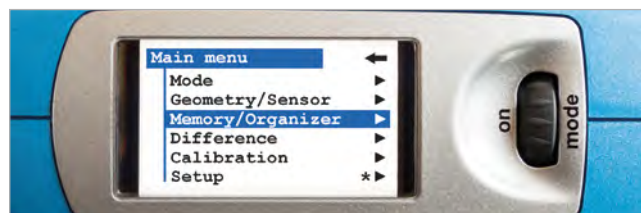

Gloss of paint or metal - from matte to mirror gloss

With the micro-gloss gloss meter you can measure any material - paints, plastics or brightened metals. Its expanded range measures from very matte to mirror like reflection of up to 2000 gloss units, automatically and without additional calibration. Always reliable results – according to international standards.

Smart functions for any task

Different tasks require different tools. The easy to turn-scroll wheel of the glossmeter quickly shows you all needed functions – even without a PC:

The **Basic mode** is your tool to quickly check the gloss of a few samples.

The **Statistic mode** not only shows the average, but all statistical data needed to judge whether the measured difference is significant or how uniform the surface gloss is on your sample. You define what you want to see: mean, standard deviation, range, min/max, ...

The **Difference mode** allows you to define a reference with Pass/Fail limits and will compare all of the following measurements to the selected reference. The Pass/Fail indication is colorfully shown on the high resolution display – ideal for production control.

The **Continuous mode** is the most efficient way to quickly check the uniformity of a large sample surface. You define the measurement interval and are now ready to continuously measure the gloss by sliding the micro-gloss over the surface. When finished, the average with min – max range are displayed.



Basic mode

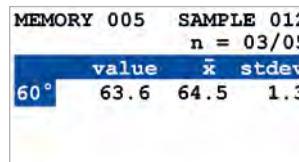

Statistic mode

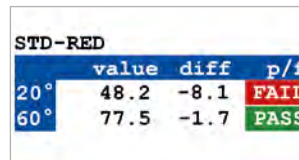

Difference mode

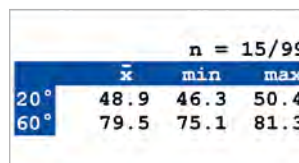

Continuous mode

Technical Performance: Unsurpassed in the industry

No matter how harsh your production are or how tight your limits may be, accuracy and reliability of the micro-gloss are proven by thousand of users to guarantee always the highest quality.

The long-term stable LED light source of the glossmeter provides not only highly repeatable results for many years, but also will never burn out. A 10 year warranty on the lamp life is guaranteed. Due to advanced temperature control, the micro-gloss assures the highest stability of the gloss readings – if you are in the lab or move to a “hot spot” on the line.

Our patented calibration procedure during the production of the glossmeters enables an excellent inter-instrument agreement. No matter how far your customer may be away, if he is one of the thousands of micro-gloss users, he will read the same values as you.

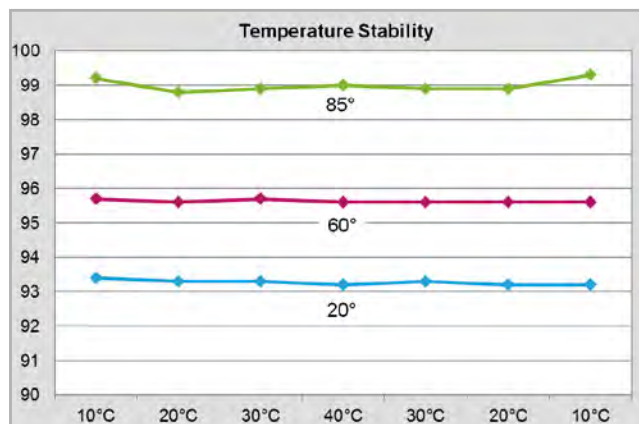
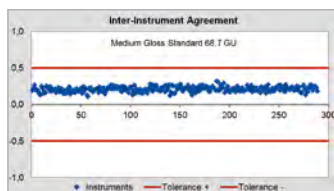
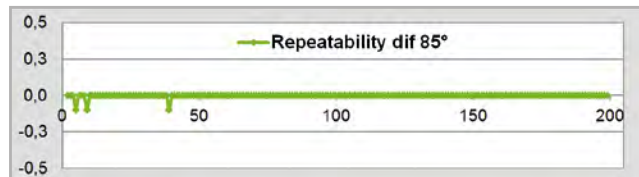
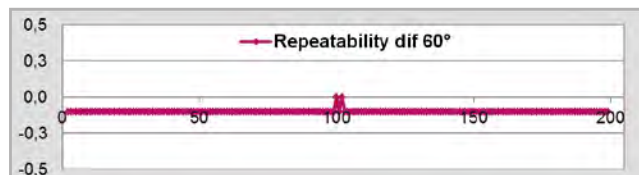
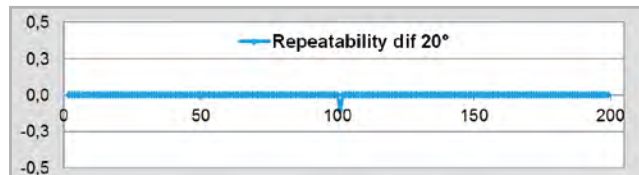

micro-TRI-gloss

See changes under the right angle

High – medium – low gloss: What is your application?

The micro-TRI-gloss combines 20°, 60°, 85° in one glossmeter – as handy as the one angle unit. Having three geometries in one unit allows you to be in compliance with international standards and to quickly recognize quality variations.

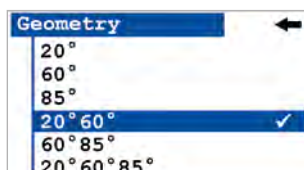

All selected angles measure at the same location and the results are displayed instantly – including Statistics, Difference, or Pass/Fail.

The different gloss of these two samples is more clearly shown in the 20° readings.

STD-RED			
	value	diff	p/f
20°	48.2	-8.1	FAIL
60°	77.5	-1.7	PASS



In order to obtain differences clearly, over the whole range from matte to high gloss, three measurement geometries were specified in international glossmeter standards. Each geometry is optimized for a specific gloss range.

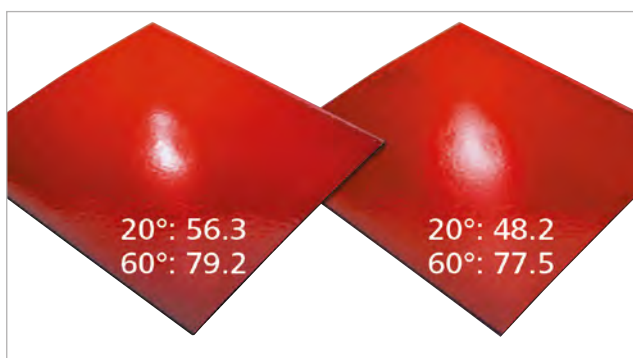

micro-TRI-gloss μ

Gloss and Film Thickness in one Instrument

An efficient coatings process should use as little paint as possible and fulfill the quality specifications given by the customer. Gloss and film thickness are important QC criteria for coatings. The micro-TRI-gloss M measures both, at the same position and in seconds. This saves time and is ideal for checks in the field – only one instrument to carry.

- Simultaneous display 20°, 60°, 85° – for high gloss to matte coatings
- Dual sensor Fe/NFe – measures thickness on steel as well as on aluminum



Standards

	Gloss	Thickness
ISO	2813, 7668	2178, 2360, 2808
ASTM	D523	B499, D1400
DIN	675301	

micro-gloss S-Family

A matte finish is not only a new design trend but also can be a must for applications where low or no reflection is essential – such as car interior. Often, a variety of materials, from leather to plastics, is used and needs to be harmonized. Additionally, surface structures vary from large grains to fine stipples, usually with very low gloss. In order to guarantee a uniform look among the various parts, very tight tolerances are specified.

Only testing instruments with excellent precision will be able to objectively control production. The new micro-gloss S family offers improved performance for 60° gloss in the critical low gloss range (0–20 GU). This excellent accuracy can be guaranteed due to our patented calibration procedure during the production of the glossmeters.



Technical Specifications

Measurement range	0 - 20 GU	20 - 100 GU	100 - 2000 GU
Repeatability	± 0.1 GU	± 0.2 GU	± 0.2 %
Reproducibility	± 0.2 GU	± 0.5 GU	± 0.5 %

Info!

Please note additional information of this applications on page 54.

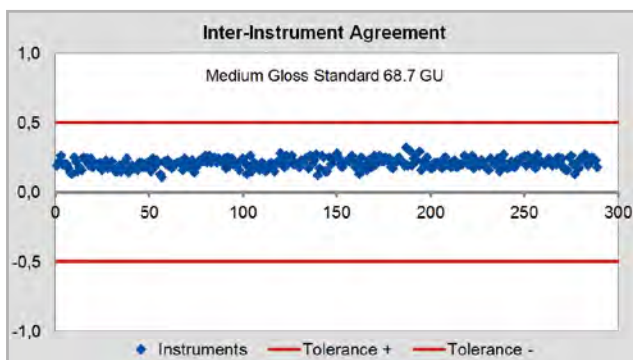

Excellent inter-instrument agreement

micro-gloss XS

Small port for small parts

Today, many products not only consist of different parts, but are composed of parts with similar surface appearance. An appealing design is important for the success of products like smart phones, computers or home electronics. Often small parts are integrated in a large part or connect parts such as frames, buttons or decorative trim pieces. Their size and design make it difficult to evaluate with a classical gloss meter.

The micro-gloss XS is a 60° gloss meter with a small measuring area of 2×4 mm, an ideal solution to measure small parts and assure that they fit with the large components.

An additional version, micro-gloss 60° XS-S, is available for measuring very matte surfaces with increased technical performance.

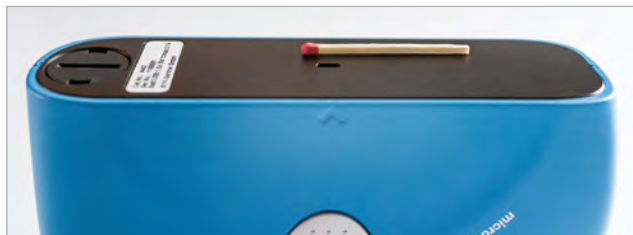

micro-gloss 60° robotic

Automatic online gloss control

A stable running process is the key for uniform and consistent quality. Therefore, gloss needs to be measured on a routine basis in the production process and the measurement results need to be documented for clear communication.

The new micro-gloss robotic allows automatic appearance control. With the robust fixture it can be integrated into measuring systems like a xy-table. Thus, measurements are taken always on the same sample area, which ensures repeatable positioning and reliable results.



Stable process means consistent quality

Automated gloss control allows measuring a high number of parts and provides complete and representative data for statistical process control - 100 % checking becomes reality.

The calibration tile is supplied in a special track which enables fast and automatic calibration on a regular basis - accuracy at any time.



micro-gloss 60° S robotic

A matte finish is not only a new design trend, but also can be a challenge for product harmony. In order to guarantee a uniform look among the various components of a product, very tight tolerances are specified.

Only test equipment with excellent precision will be able to objectively control production. The new micro-gloss 60° S robotic offers improved performance for 60° gloss in the critical low gloss range (0-20 GU). This excellent accuracy can be guaranteed due to our patented calibration procedure during the production of the gloss meters.



Technical Specifications

	0 - 20 GU	20 - 100 GU	100 - 2000 GU
Measurement range			
Repeatability	± 0.1 GU	± 0.2 GU	± 0.2 %
Reproducibility	± 0.2 GU	± 0.5 GU	± 0.5 %

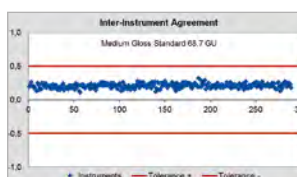

Gloss Measurement for Specific Applications

Specific materials require specific measuring angles: Ceramic materials, plastic films and solid plastics, paper and paperboard either measure specular gloss at the standard geometries 20°, 60°, 85° or at industry specific geometries 45° or 75°.

micro-gloss 45°

Plastic films and solid plastics, both opaque and transparent, are often measured at 45° angle for intermediate and low gloss levels. For films that transmit light, a matte black backing such as “Black scrub panel” cat. no 5015 (see page 174), must be placed behind the sample. Erroneous measurements will occur without a suitable backing.

Standard test methods ask for readings on at least three portions of each specimen to get an indication of gloss uniformity. The statistic mode of the micro-gloss will show the average and range or standard deviation as a measure of sample uniformity.

Ceramics, porcelain enamels and other finishes use the 45° geometry and often provide a comparison of their resistance to acid, alkali, or other environmental factors by measurement of gloss loss.

$$\text{Gloss loss, \%} = 100 \times \frac{G_{\text{initial}} - G_{\text{final}}}{G_{\text{initial}}}$$

In order to evaluate change of gloss it is essential to take multiple readings over the entire sample surface and evaluate the average to ensure representative results.



micro-gloss 45°: Specialized glossmeter for ceramics, plastics and plastic films.

FILM A4	SAMPLE 07
	n = 02/03
	value \bar{x} range
45°	61.7 60.5 1.2



Standards

ASTM	C346, D2457
JIS	Z8741

Technical Specifications

Geometry	Application	Measurement Range
45°	Ceramic, Plastic, Plastic Films	0 - 180 GU

Gloss Measurement for Specific Applications

micro-gloss 75°

Especially coated paper, but also a variety of uncoated papers request gloss control. The 75° geometry is suitable for most ink films on paper and paperboard. Color differences have a negligible influence on measured gloss. For example, a white surface will measure less than one gloss unit higher than an otherwise identical black surface.

Very high gloss papers (laquered, highly varnished or waxed) should use a 20° measurement geometry. As defined in the TAPPI standard for bath QC at least ten test specimens free from folds or wrinkles or other imperfections are to be checked. The smart-lab Gloss software is ideal to document and communicate the measurement results. Its project management can be used to record the quality of one material over time and send the data either by PDF or Excel to all involved parties.

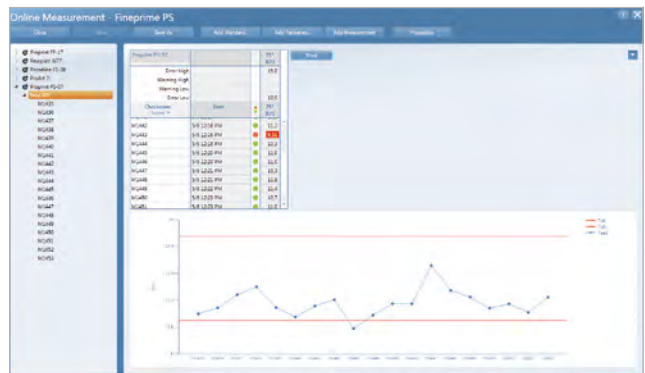

Another typical material to be tested for specular gloss using the 75° geometry is vinyl siding made principally from rigid PVC and is used to clad exterior walls of buildings.

In order to evaluate the uniformity over large areas, the "Continuous mode" of the micro-gloss will display the gloss values in a predefined measurement interval while moving the instrument over the surface.

select Continuous mode...

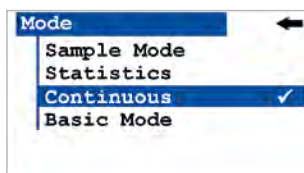

and measure:

COUNTRY		VINYL 06		
		n = 12/99		
	\bar{x}	min	max	
75°	48.9	45.3	51.6	



micro-gloss 75°: Specialized glossmeter for paper, paperboard and structured plastic e.g. vinyl siding.

Standards

ASTM	D2457, D3679
JIS	Z8741
TAPPI	T480

Technical Specifications

Geometry	Application	Measurement Range
75°	Paper, Vinyl Siding	0 - 140 GU

smart-chart

The smart way to communicate



smart-lab Gloss

- Measure your products offline or online and transfer the results to smart-lab Gloss. Immediately, you will get a professional QC-report, including data table and graph.
- Setup your product specifications in the Standard management module, with Pass – Warning – Fail limits for display in your QC-reports.
- Manage your lab work in projects to show production process stability using trend reports.

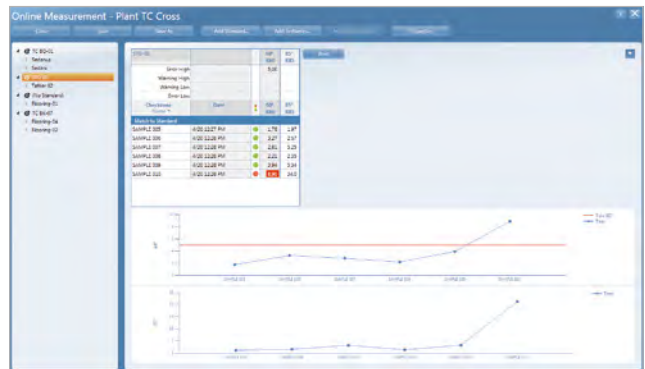

smart-process Gloss

- Ideal for products with multiple measurement locations.
- Setup Organizers for menu guided test sequences and clear sample identification.
- Efficient QC analysis for process control with a high sampling rate. The data are saved in a SQL database which allows handling of large data sets over a long time period.
- Flexible data analysis based on defined identification parameters for a certain time range. Monitor your process stability with scorecards, trend reports and SPC charts (box plot).

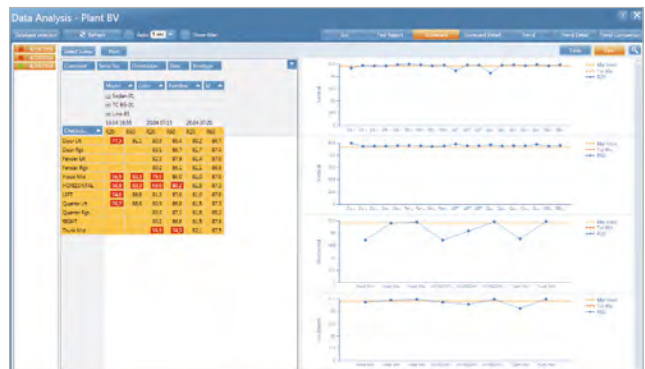

In compliance with:

Standards

ISO	2813, 7668
ASTM	D 523, D 2457
DIN	67530
JIS	Z 8741



Ordering Information

Cat. No.	Description
4560	micro-gloss 20°
4561	micro-gloss 60°
4562	micro-gloss 85°
4563	micro-TRI-gloss
4564	micro-TRI-gloss μ
4565	micro-gloss 60° S
4566	micro-TRI-gloss S
4567	micro-gloss 45°
4568	micro-gloss 75°
4569	micro-gloss 60° XS
4570	micro-gloss 60° XS-S
4573	micro-gloss 60° robotic
4576	micro-gloss 60° S robotic

Comes complete with:

Glossmeter
 Holder with integrated calibration tile
 Traceable certificate
 USB-cable, Battery
 Operating manual
 Carrying case
 Software for download:
 smart-lab Gloss or smart-process Gloss with 2 licenses

Note: After software download both software packages can be used for 30 days free trial. Thereafter, the user needs to decide and register for one software package.

System Requirements:

Operating system: Windows® 7 SP1, 8.1 or 10
 Microsoft® .NET Framework 4.5.2
 Hardware: Core 2 Duo, 2.5 GHz, i7 recommended or equivalent
 Memory: 4 GB RAM, 8 GB recommended
 Hard-disc capacity: 2 GB during installation
 Monitor resolution: 1280 x 1024 pixel or higher
 Interface: free USB-port

Technical Specifications

Geometry	Application	Measuring Area
20°	high gloss	10 x 10 mm (0.4 x 0.4 in)
60°	semi gloss	9 x 15 mm (0.35 x 0.6 in)
85°	low gloss	5 x 38 mm (0.2 x 1.5 in)
20°, 60°, 85°	universal	see single angle
20°, 60°, 85°	universal	see single angle
60°	semi gloss	9 x 15 mm (0.35 x 0.6 in)
20°, 60°, 85°	universal	see single angle
45°	Ceramic, Plastic, Film	9 x 13 mm (0.35 x 0.5 in)
75°	Paper, Vinyl Siding	7 x 24 mm (0.3 x 0.95 in)
60°	semi gloss	2 x 4 mm (0.08 x 0.16 in)
60°	semi gloss	2 x 4 mm (0.08 x 0.16 in)
60°	semi gloss	9 x 15 mm (0.35 x 0.6 in)
60°	semi gloss	9 x 15 mm (0.35 x 0.6 in)
Measurement range¹	0 - 100 GU	100 - 2000 GU
Repeatability²	± 0.2 GU	± 0.2 %
Reproducibility²	± 0.5 GU	± 0.5 %
Spectral sensitivity	CIE standard observer for illuminant CIE-C	
Measuring time	0.5 seconds / geometry	
Thickness:		
Substrate	Fe: magnetic, NFe: non-magnetic	
Measurement Range	0 - 500 μ m (0 - 20 mils)	
Accuracy	$\pm (1.5 \mu\text{m} + 2\%$ of measured value)	
Memory	999 readings with date and time	
Interface	USB	
Power supply	one 1.5V AA Alkaline Battery 4,000 readings or via USB-port	
Dimensions	155 x 73 x 48 mm (6.1 x 2.9 x 1.9 in)	
Weight	0.4 kg (0.9 lbs)	
Operating temperature	15 - 40 °C (60 - 104 °F)	
Relative humidity	up to 85 %, non-condensing	

¹ for 45° and 75° glossmeters see previous pages

² for S-Type glossmeters see previous page



Ordering Information

Cat. No.	Description
4405	USB-Cable micro-gloss family
4866	Software smart-lab Gloss
4867	Software smart-process Gloss

Note: smart-chart license fee for more than two installations is quantity dependent. Please contact your local BYK-Gardner representative.

Accessories

For data transfer from the glossmeter to a PC, USB-A
 Software for professional analysis and documentation in the laboratory
 Process QC Software for analysis of multi-component products

Export / Import	Standards (.xml format) Organizer (.xml format)
Languages	English, German, French, Italian, Spanish, Chinese, Japanese

Accessories for Cosmetics

Measurement of cosmetic products

The cosmetic industry is very much driven by aesthetics. Consistent raw materials and stable process parameters are the key to uniform and repeatable color and appearance quality. For each different product type (e.g. nail polish, lip gloss, eye shadow, foundation...) a standardized sample preparation is required in order to guarantee repeatable measurement results.



Measurement of cylindrical products

Sample Holder Cosmetics

The Sample Holder Cosmetics is especially designed for gloss measurements using micro-gloss on cylindrical shaped products, e.g.

- Cosmetic Packaging such as hairspray cans



For repeatable results the product is placed into a sample drawer, which can be comfortably opened and closed. Magnets keep the drawer to hold the micro-gloss in place and allow non-contact measurements of your products in a completely shielded compartment.

- Easy-handling
- Precise and repeatable positioning of sample
- No ambient light
- Durable, easy-to-clean material
- Non-contact measurement

For gloss measurements using micro-gloss on cylindrical shaped products the Sample Holder Cosmetics is used together with a Cylinder Kit:

- Customizable inlays for various diameters of cylindrical shaped products
- Optimum form closure guarantees tight fit of inlays inside the holder

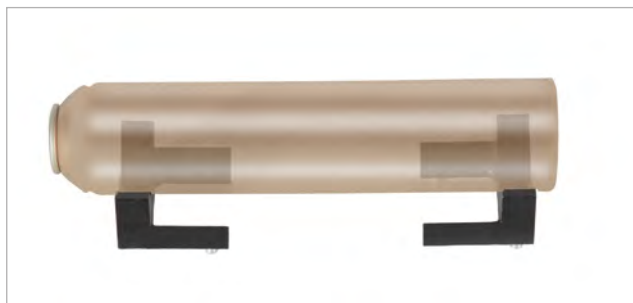

Ordering Information

Cat. No.	Description
6469	Sample Holder Cosmetics
6464	Cylinder Kit

Accessories

Dimensions: 24 x 10 x 10 cm (9.4 x 3.9 x 3.9 in.)
 Weight: 2.2 kg (4.9 lbs)
 Max. length of cylinder: 229 mm
 Max. diameter of cylinder: 67 mm
 Please provide sample for customization of inlays

Measurement of wet drawdowns

Wet Drawdown Template – G

The Wet Drawdown Template – G is especially designed for gloss measurements using micro-gloss on non-drying drawdowns, e.g.

- Drawdowns of Lipstick Paste
- Drawdowns of Liquid Foundation

To simulate how the gloss of a product will look like when applied, a drawdown is made on a test chart. The template is then placed over the drawdown without touching the surface of the wet sample. For repeatable non-contact measurements, the template is equipped with a mask to hold the micro-gloss.



- Made of easy-to-clean hard-anodized aluminium
- Non-contact measurement ensure clean and fast handling



Ordering Information

Cat. No.	Description
4439	Wet Drawdown Template – G

Accessories

Dimensions: 10.0 x 17.0 cm (3.94 x 6.69 in.)
 Min. Film Width: 35 mm (1.38 in.)
 Max. Film Width: 80 mm (3.15 in.)

Info!

Measurement results are greatly affected by application quality. Therefore the use of an automatic film applicator (e.g. byko-drive) is recommended. For more information please refer to the section "Application".

Measurement of powdery or pasty products

Sample Holder Round Dish – G

The Sample Holder Round Dish – G is developed for gloss measurement using micro-gloss on powdery or pasty materials, e.g.

- Pressed Powders
- Creamy Eye Shadows



For repeatable results the product is pressed or pured into a sample cup. During sample preparation of pressed powders, it is important to always maintain the same plunger pressure as well as the same plunger tissue. It is recommended to use a fine-woven fabric to create a smooth, non-textured surface. The holder is equipped with a mask onto which the micro-gloss is placed for non-contact measurements.

- Made of easy-to-clean hard-anodized aluminium
- Non-contact measurement to protect the instruments optics
- Customized adapter rings are offered to use the holder with custom specific cuvettes



Ordering Information

Cat. No.	Description
4453	Sample Holder Round Dish – G
6416	Adapter Rings for 4453

Accessories

Including adapter ring and 5 sample dishes ø 35.5 mm, height 4.5 mm, Measurement distance approx. 1 mm
 Five adapter rings of various sizes
 Please specify diameter (max. size of sample dish: ø 60 mm)

Calibration Holder

Replacement holder with high gloss calibration tile.



Checking Standard

In order to control the performance and linearity of the glossmeter it is recommended to use a checking standard periodically. The control interval is dependent on the usage conditions of the glossmeter.

The gloss tiles are built into an aluminum track that the glossmeter fits into to guarantee accurate and repeatable measurements. The included certificate is traceable to international institutes.

Ordering Information

Cat. No.	Description
4441	Calibration Holder 20°
4443	Calibration Holder 60°
4445	Calibration Holder 85°
4447	Calibration Holder TRI
4455	Calibration Holder 45°
4457	Calibration Holder 75°
4559	Calibration Holder 60°XS

Comes complete with:

Holder with integrated calibration tile and traceable certificate



Ordering Information

Cat. No.	Description
4422	Checking Standard micro 20°
4462	Checking Standard micro 60°
4464	Checking Standard micro 60° S
4487	Checking Standard micro 85°
4434	Checking Standard TRI
4438	Checking Standard micro-TRI S
4433	Checking Standard Mirror, TRI
4458	Checking Standard micro 45°
4459	Checking Standard micro 75°
4490	Checking Standard micro 60°XS
4493	Checking Standard micro 60°XS Mirror

Comes complete with:

Checking standard in aluminum track with traceable certificate

Technical Specifications

Dimensions	
170 x 103 x 17 mm (6.7 x 4.1 x 0.7 in)	High and semi gloss tile
170 x 103 x 17 mm (6.7 x 4.1 x 0.7 in)	High and semi gloss tile
170 x 103 x 17 mm (6.7 x 4.1 x 0.7 in)	High gloss and low gloss tile, approx. 5 GU at 60°
170 x 103 x 17 mm (6.7 x 4.1 x 0.7 in)	High and semi gloss tile
170 x 103 x 26 mm (6.7 x 4.1 x 1 in)	High gloss and 3 semi gloss tiles 20°, 60°, 85°
170 x 103 x 26 mm (6.7 x 4.1 x 1 in)	High gloss and 3 semi gloss tiles 20°, 60°, 85°, 60° tile approx. 5 GU
170 x 103 x 26 mm (6.7 x 4.1 x 1 in)	High gloss and 3 semi gloss tiles 20°, 60°, 85°, highly reflective
170 x 103 x 17 mm (6.7 x 4.1 x 0.7 in)	High and semi gloss tile
170 x 103 x 17 mm (6.7 x 4.1 x 0.7 in)	High and semi gloss tile
170 x 103 x 17 mm (6.7 x 4.1 x 0.7 in)	High and semi gloss tile
170 x 103 x 17 mm (6.7 x 4.1 x 0.7 in)	High and semi gloss tile, highly reflective

Glossmeter Accessories

Additional Standards

These 100 x 100 mm (4 x 4 in) glass tiles can be used for any glossmeter as a reference. If standards with specific values are needed, ask for Cat. No. 4057 or 4058.



Ordering Information

Cat. No.	Description
4050	High Gloss Standard
4051	Semi Gloss Standard 20°
4052	Semi Gloss Standard 60°
4053	Semi Gloss Standard 85°
4056	Mirror Gloss Standard
4057	Special Standard, Black Glass
4058	Special Standard, Mirror

Comes complete with:

Standard
Traceable certificate
Protective case

Technical Specifications

Black glass tile, polished, for 20°, 60°, 85°
Black glass tile, 20° value approx. 60 to 70 gloss units
Black glass tile, 60° value approx. 40 to 50 gloss units
Black glass tile, 85° value approx. 15 to 25 gloss units
High gloss, polished mirror, for 20°, 60°, 85°
Black glass tile, gloss value can be defined
Semi gloss, highly reflective, gloss value can be defined

Introduction

Reflection Haze

High quality (class A) surfaces are expected to have a clear and brilliant appearance. Microstructures, e. g. poor dispersion, can cause a milky appearance. This effect is described as milkiness or haze.

A high gloss surface with microscopic texture has diffused light with low intensity adjacent to the main direction of reflection. The majority of the incident light is reflected in the specular direction which makes the surface appear highly glossy with image forming qualities, but with a milky haziness on top of it.

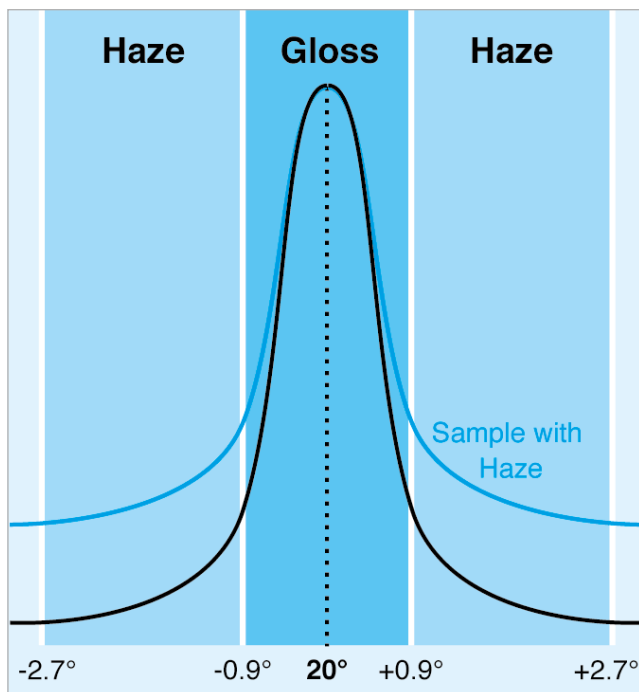
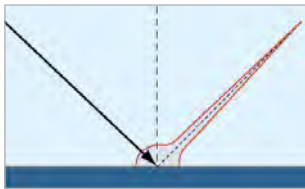

HAZE



Objective Measurement of High Gloss Surfaces: Gloss and Haze

The phenomenon haze can be seen on high gloss surfaces only. Therefore, 20° geometry is used just like with a glossmeter. The aperture range of a 20° gloss meter is 1.8°. Two additional sensors next to the gloss detector measure the intensity of the diffused light, responsible for haze. Thus, the specularly reflected and scattered light are measured simultaneously. In order to better correlate with the visual perception, haze is displayed in a logarithmic scale – the lower the haze reading the better the surface.

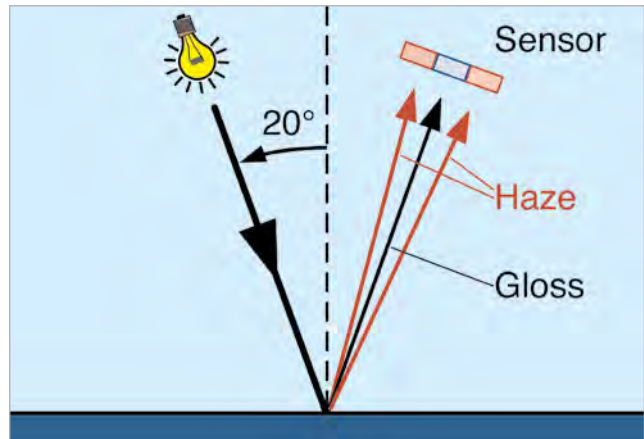

Analysis of High Gloss Surfaces: Gloss and Haze

Haze is often caused by specific parameters in the production process, i.e.:

- Pigment type and degree of dispersion
- Binder and additive type
- Application and processing

Examples

Degree of Dispersion

The graph on the right shows the influence of degree of dispersion on gloss and haze. Pigment particles smaller than 10 µm will show a tremendous reduction in haze while the gloss value is nearly the same.

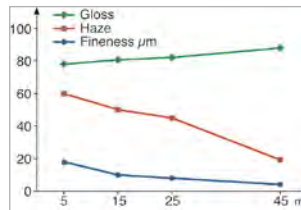

Application Type

In practice it is important to test the process compatibility of a paint system. In the example on the side, different paint systems were applied with electrostatic and pneumatic equipment: System A flocculates under the electrostatic spray condition which can be seen in the increased haze value. System B shows an excellent low haze value with pneumatic application, but a tendency to flocculation with electrostatic equipment. System C was optimized for either application.

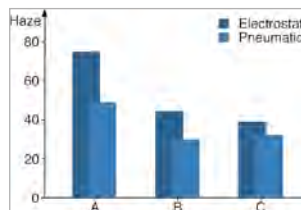

Polishing

Other causes for haze can be weathering, abrasion or polishing marks.

Simultaneous measurement of gloss and haze allows objective evaluation of the surface quality. BYK-Gardner offers a stationary haze meter, the haze-gloss, especially developed for the use in the laboratory.

haze-gloss

The Reference Instrument for any Application

The hazemeter was designed for the needs in the laboratory. Gloss, haze and mirror reflection can all be measured with one instrument for low to high gloss surfaces.

Gloss 20°, 60°, 85° and haze

- Mirror reflection for materials with very high reflection capabilities, such as metals
- Reference beam, closed optics and self diagnosis guarantee accurate quality control
- Statistics with average, min/max and standard deviation
- Large storage capacity and data transfer from the hazemeter to a PC prepare you for ISO 9000

Quick Measurement of many Samples

- Foot switch and automatic measurement for fast sampling
Illuminated target facilitates sample positioning
- Ready for measurement without warm-up time
- Long-term calibration and menu guided operation – simple and secure
- Operation in English, German, French, Spanish, and Italian – switchable

Standards

ISO	2813, 13803
ASTM	D 523, D 2457, E 430
DIN	67530



Ordering Information

Cat. No.	Description
4601	haze-gloss

Comes complete with:

Hazemeter
High gloss and haze standard incl. certificate
easy-link software
Interface cable
Foot switch
Power cord
Operating manual

Technical Specifications

Gloss	
Measurement Range	0 - 2000 GU ¹
Repeatability	0.2 GU ²
Reproducibility	0.5 GU ²
Haze	
Measurement Range	10 - 2500 HU ³
Repeatability	1 HU*
Reproducibility	7 HU*
Measuring Area	20°: 15 x 15 mm (0.6 x 0.6 in) 60°: 15 x 27 mm (0.6 x 1.0 in) 85°: 8 x 60 mm (0.3 x 2.4 in)
Memory	9 x 600 values
Interface	serial RS 232
Power Supply	115 / 230 V, 50 / 60 Hz, requirement 50 VA
Dimensions	33 x 52 x 40 cm (13 x 20.5 x 15.7 in)
Weight	14.3 kg (31.5 lbs)

¹ Gloss Units, ² 0 - 100 GU, ³ Haze Units (Hlog), * measured on high gloss standard

Documentation of Measurement Data

The program easy-link allows quick data transfer from the haze-meter to Excel® for further analysis and professional documentation.

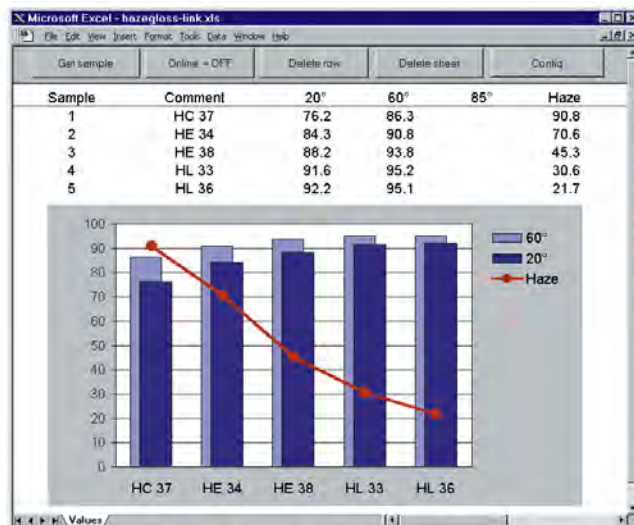

Ordering Information

Cat. No.	Description
4616	Checking standard 20°, for 4601
4617	Checking standard 60°, for 4601
4618	Checking standard 85°, for 4601
4624	Mirror Gloss Standard, for 4601
4614	High Gloss Standard haze-gloss
4615	Haze Standard haze-gloss
4623	Sample Table
4626	USB-cable haze-gloss
4545	BYKWARE easy-link

Accessories

Black glass, semi gloss for checking purposes, certificate included
Black glass, semi gloss for checking purposes, certificate included
Black glass, semi gloss for checking purposes, certificate included
High gloss, polished mirror, for 20°, 60°, 85°, certificate included
Replacement calibration standard gloss, certificate included
Replacement calibration standard haze, certificate included
Larger platform for sample support table, 28 x 15 cm (11 x 6 in)
For data transfer from hazemeter to a PC
Software for direct data transfer and documentation in Excel®



Introduction

The total appearance and the visibility of structures depend on the structure size, the observing distance and the image forming quality.

Structure size

Surfaces with different structure sizes will appear visually different:



Small structures



Large structures

The waviness of automotive paints is in a range of approx. 0.1 to 30 mm wavelength. These phenomena are often visually evaluated and subjective terms like degree of peel or texture are used as descriptions.

Orange peel can be seen on high gloss surfaces as a wavy pattern of light and dark areas.

Depending on the slope of the structure element the light is reflected in various directions. Only the elements reflecting the light in the direction of our eyes are perceived as light areas.

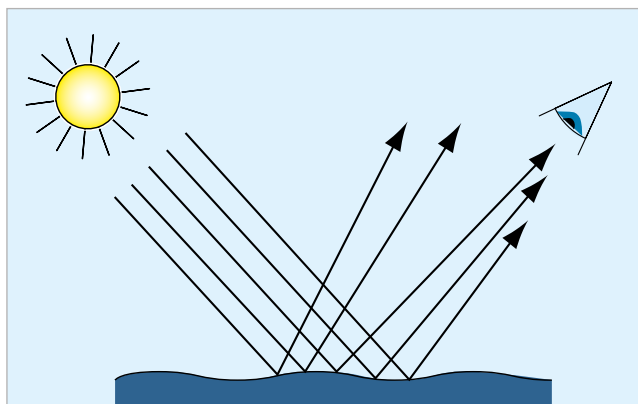

ORANGE PEEL / DOI



Observing distance

Visibility of structures is dependent on the observing distance. The greater the distance, the smaller objects will appear. Structures with a size of 10 to 30 mm can best be seen at a distance of approx. 3 m. Fine structures in a range of 0.1 to 1 mm can only be recognized at a close distance.

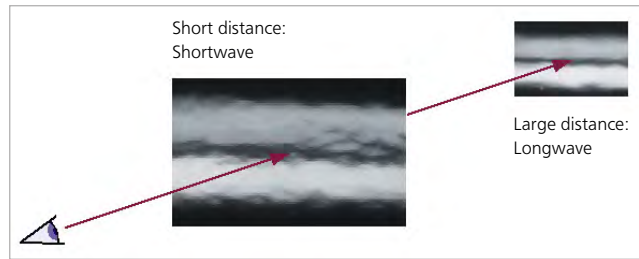

Resolution of our eyes

The resolvable structure size is also dependent on the observing distance. Very fine structures that are below the human eye's resolution (approx. 0.1 mm) can no longer be recognized as a light / dark pattern, even at a close distance. The result is a reduction of the image forming quality (IFQ). At 3 m distance, structures between 1 - 3 mm can hardly be resolved as a waviness but influence the appearance

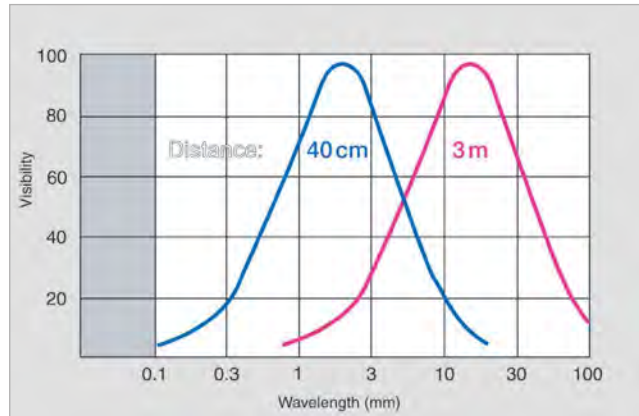

Image Forming Quality (IFQ)

The higher contrast and sharpness of a reflected object, e.g. the edges of black and white lines, the better the image forming quality will be. Fine structures disturb the reflected image, consequently edges become blurry and are no longer sharp.

Image Forming Quality at a close distance:

Distinctness of Image (DOI)

DOI can also be described with terms like brilliance, sharpness or clarity. DOI is diminished by very fine structures close to the human eye resolution (smaller than 0.3 mm).

Image Forming Quality at a far distance:

Wet Look

At a distance of 3 m, the image forming quality is mainly influenced by structures between 1 - 3 mm. This effect is referred to as Wet Look.

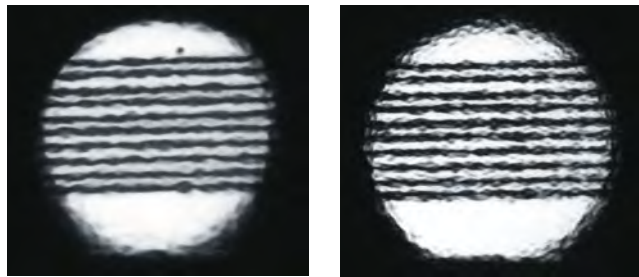

Please refer to section
wave-scandal

Simulation of the Visual Perception Waviness

The wave-scan simulates visual perception. Like our eyes, the instrument optically scans the wavy light / dark pattern. A laser point light source illuminates the specimen at a 60° angle and a detector measures the reflected light intensity at the equal but opposite angle. The orange peel meter is rolled across the surface and measures point by point the optical profile of the surface across a defined distance. The wave-scan analyzes the structures according to their size. In order to simulate the human eye's resolution at various distances, the measurement signal is divided into several ranges using mathematical filter functions:

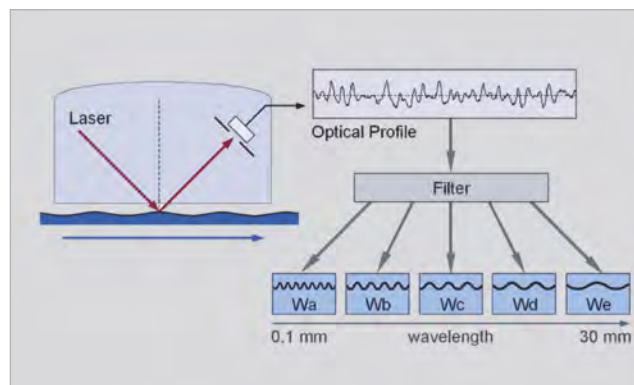

- Wa 0.1 0.3 mm wavelength
- Wb 0.3 1 mm wavelength
- Wc 1 3 mm wavelength
- Wd 3 10 mm wavelength
- We 10 30 mm wavelength
- SW 0.3 1.2 mm wavelength
- LW 1.2 12 mm wavelength

Dullness

Structures smaller than 0.1 mm influence visual perception, therefore the wave-scan uses a CCD camera to measure the diffused light caused by these fine structures. This parameter is referred to as "dullness".

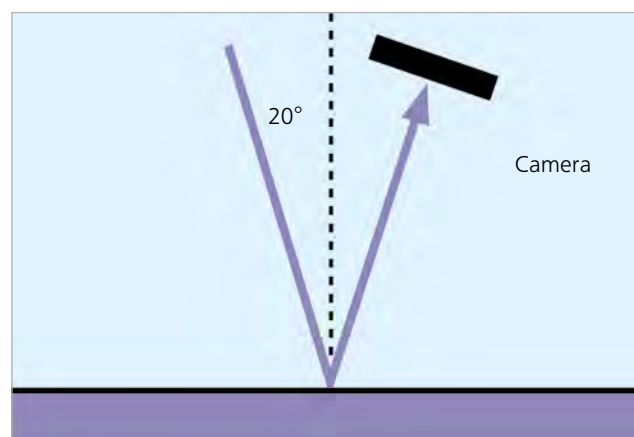

Structure Spectrum

The values of dullness and Wa to We form a "structure spectrum". This allows a detailed analysis of Orange Peel and its influencing factors, being material or application parameters.

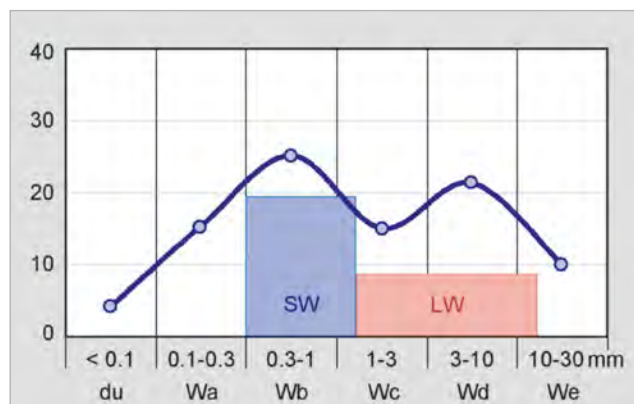

wave-scan Scales

The detailed information of the structure spectrum as well as LW and SW became the basis to correlate to customer specific scales and to the DOI as described in ASTM E430:

DOI	Function of du , Wa and Wb Correlation to ASTM E430, scaling is similar to 20° gloss
Rating:	Orange Peel based on ACT panels
Tension-Scales:	Leveling
GM-Tension	GM Specification
P-Tension	Honda Specification
H-Tension	Honda Specification
Ford Scales:	
Luster	A measurement for Gloss
Sharpness	A measurement for DOI
Orange Peel	A measurement for Leveling
Combined	An overall rating
Daimler Chrysler Scales:	
Gloss DCA	A measurement for Gloss
Dorigon DCA	A measurement for DOI
Orange Peel DCA	A measurement for Leveling
Over All DCA	An overall rating
BMW Scales:	
N1 Note 1 m	A ranking note for 1m observation
N3 Note 3 m	A ranking note for 3m observation

Interpretation of Measurement Results

Substrate Influence:

In the following graph, the substrate roughness telegraphs through the clear coat and reduces the brilliance of the coating. Sample D is a lasertex panel with a specific texture resulting in lower SW values.

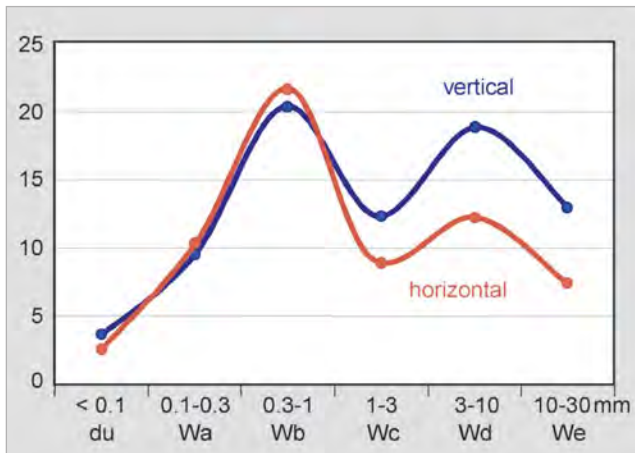
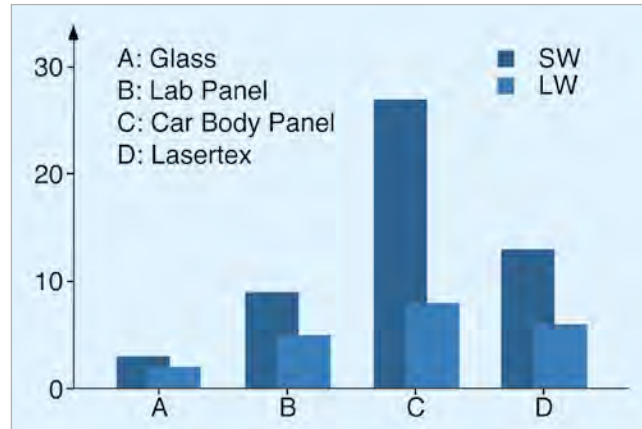

Influence of Baking Position:

In general, horizontal surfaces have shown better flow and leveling characteristics, i.e. in the values for the longer waves (Wc ... We). The smaller waves are hardly influenced by the baking position.

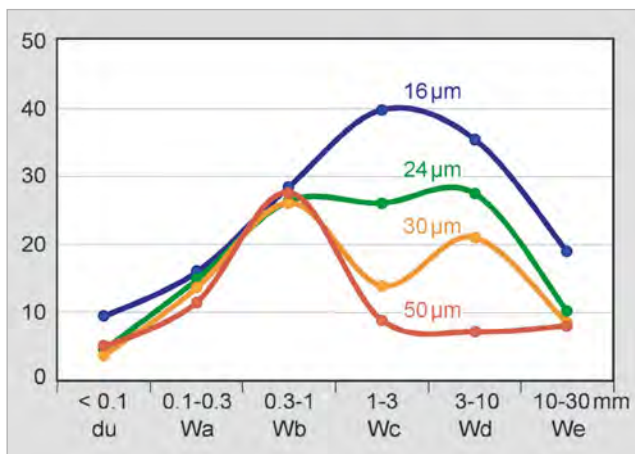

Influence of Film Thickness:

The structure spectrum can help optimize the appearance, e.g. in determining the optimum film thickness. Increasing clear coat thickness improves flow and leveling. In the graph this can be seen in decreasing Wc and Wd values.

wave-scan *dual*

Orange Peel and DOI measurement on high to semi gloss surfaces

... appearance control is no longer limited to final topcoat inspection. The orange peel meter scans the optical profile of high gloss surfaces using a laser light source. An additional, infrared-high energy LED allows measuring the same structure spectrum (0.1 - 30 mm) on medium gloss surfaces. The dullness measurement is recorded with state-of-the-art CCD camera technology. It gives information on the image forming qualities of the surface caused by structures < 0.1 mm.

Close the appearance control loop for the entire paint process

Thus, the surface quality after each paint process step can be objectively evaluated. No more guessing which substrate layer is influencing the final appearance. The wave-scan *dual* will help you to objectively analyze appearance problems and reduce the time necessary for trouble shooting.

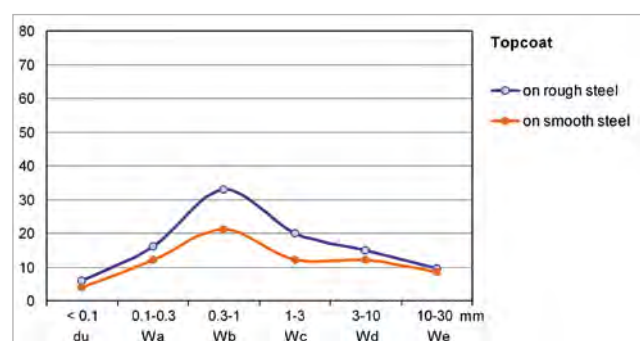
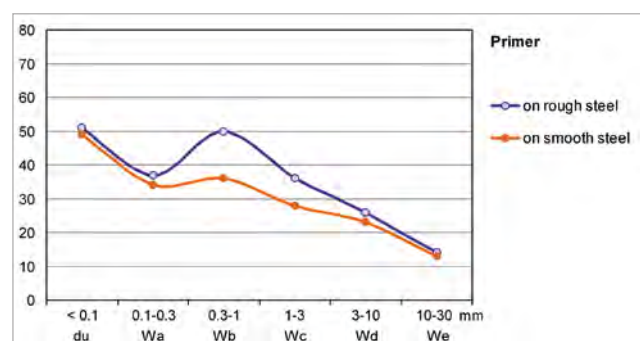
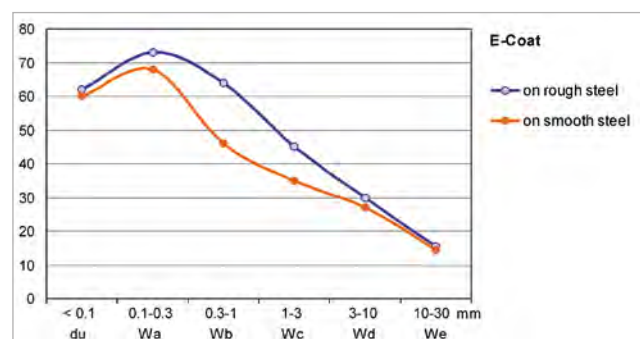
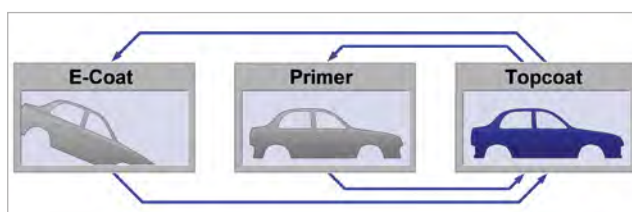

Example: Influence of Steel Quality on Final Appearance

Step 1: Appearance Control after E-coat

Same E-coat system was applied on rough and smooth steel. The influence of rougher steel can be seen in increased Wb and Wc-values.

Step 2: Appearance Control after Primer Surfacer

The primer surfacer was applied on both panels. The roughness of the steel quality can still be detected in increased Wb and Wc-values. This primer system could not completely cover the steel influence.

Step 3: Appearance Control after Topcoat

The final appearance shows higher shortwave values on the rougher steel panel. Therefore, the smooth panel will appear more brilliant.

wave-scan *dual* – a diagnostic tool for trouble shooting and optimizing appearance

Now, you can establish appearance specifications for each paint layer to ensure the final appearance is always on target.

Objective and reliable appearance data

- Good correlation to wave-scan DOI on high gloss surfaces
- Good correlation to mechanical profilometer readings on medium gloss surfaces

Easy to use with one hand

- For flat and curved areas
- Small and light weight
- Scroll wheel operation and multilingual menu
- Selectable scales and scan lengths
- Full statistics with saving in selectable memories
- USB port for data transfer to PC
- Software smart-chart:
 - Organizer files for sample identification
 - Data management with SQL Database
 - Standard QC Reports



select mode ...

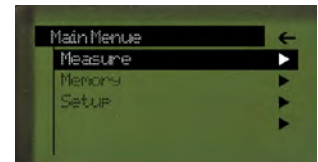

and measure

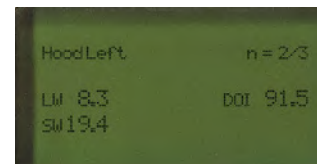
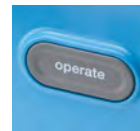

Always ready

The orange peel meter is operated with a rechargeable battery pack (Li-Ion). The docking station automatically charges the battery pack and transfers the measured data to the PC.

Optionally, the instrument can be operated with 3 standard mignon alkaline or rechargeable batteries - good for 1000 readings.



Ordering Information

Cat. No.	Description
4840	wave-scan dual

Comes complete with:

Orange peel meter with protective cover,
Certificate,
Checking tile,
Software smart-process with 2 licenses for download
Docking station and USB-cable,
2 rechargeable Li-Ion battery packs,
Battery holder for AA batteries,
3 Batteries, Operating manual,
Carrying case
Training

System requirements:

Operating system: Windows 7 SP1, 8.1 or 10
Microsoft® .NET Framework 4.5.2
Hardware: Core 2 Duo, 2.5 GHz; i7 recommended, or equivalent
Memory: 4 GB RAM, 8 GB recommended
Hard-disk capacity: 2 GB during installation
Monitor resolution: 1280 x 1024 pixel or higher
Interface: free USB-port

Technical Specifications

Application	
High to Semi Gloss	du < 65, linear range
Structure Spectrum	
du	< 0.1 mm
Wa	0.1 to 0.3 mm
Wb	0.3 to 1 mm
Wc	1 to 3 mm
Wd	3 to 10 mm
We	10 to 30 mm
Repeatability¹	du < 40: 4% or > 0.4 du > 40: 6% or > 0.6
Reproducibility¹	du < 40: 6% or > 0.6 du > 40: 8% or > 0.8
Object Curvature	radius > 500 mm
Min. Sample Size	35 mm x 150 mm
Scan Length	5 / 10 / 20 cm
Resolution	375 points/cm
Memory	1500 readings
Interface	USB port
Languages	English, French, German, Italian, Japanese, Portuguese, Spanish
Light Source	Laser diode, LED and IR-SLED
Laser Energy	< 1 mW (Laser class 2)
Dimensions	150 x 110 x 55 mm (5.9 x 4.3 x 2.2 in.)
Weight	650 g (1.5 lbs)
Power Supply	rechargeable battery pack or 3 alkaline AA Batteries, approx. 1000 readings
Temperature Range	operation: +10 °C to 40 °C (+ 50 °F to 104 °F) storage: 0 °C to 60 °C (+ 32°F to 140 °F)
Rel. Humidity	up to 85 % at 35 °C (95 °F) non-condensing

¹Standard deviation

Training wave-scan dual

BYK-Gardner offers you more than just an instrument. We assist you in operating the wave-scan system and understanding your appearance readings. As a result you will be able to use the orange peel meter to save time and money and at the same time improve your quality.

Therefore, the instrument comes with a one day training course including:

1. Orange Peel and DOI Theory

- Visual perception and instrumental measurement of Orange Peel and DOI
- Data interpretation: How can the structure spectrum be used to optimize process / material parameters

2. Operation and Software Training

- Set-up of an "Organizer" to create a routine measurement procedure
- Programming of the instrument with "organizer" and measurement of several samples
- Direct data transfer to Excel for documentation of individual readings
- Data transfer to smart-chart software and saving in a database for routine QC

- Data analysis using standard QC-reports:
 - Summary by lines to show at one glance how various colors are running at different paint lines
 - Trend chart to show how specified zones perform over a defined time range
 - SPC-chart for daily process control of your critical colors and highrunners: xR-chart
 - Zone profile for trouble shooting using the structure spectrum

Create your own reports in Excel®

- Transfer data from the database to Excel®
- Pivot function to define layout in Excel®

The training can be performed in one day or two half days.

It is recommended to split the training into two half days:

Day 1: Theory and basic operation (set-up organizer, taking readings and saving data in a database)

Day 2: 3-4 weeks later to ensure readings were taken and saved in a database. Data analysis and standard QC reports can be explained using customer specific data.



Ordering Information

Cat. No.	Description
4843	Checking Tile wave-scan dual
4841	Docking Station, for 4840/4846
4842	Battery Pack, for 4840/4846
4831	Software smart-chart

Accessories

Replacement - please contact your local service department for replacement of your checking tile.

Incl. USB interface cable and recharger 100 - 240 V self adapting

Rechargeable battery for automatic charge in docking station

Software for professional analysis and documentation of color and appearance



wave-scan II

The specialist for high gloss surfaces

Surface appearance changes with the size and distinctness of structures. The wave-scan II objectively evaluates orange peel as well as brilliance of topcoat finishes.

Objective and reliable appearance data

- Excellent correlation to wave-scan DOI
- Classical Longwave and Shortwave
- Structure spectrum to analyze appearance changes
- Dullness and DOI measurement independent of the paint system

Ideal size for the production line

- Easy handling - even on the moving car body
- Small and light weight
- For flat and curved areas, radius > 50 cm
- Scroll wheel operation and multilingual menu
- Scales and scan lengths can be selected directly from menu
- Full statistics with saving in selectable memories
- Large memory for 1500 readings
- USB port for data transfer to PC
- smart-chart software:
 - Organizer files for sample id
 - Data management with SQL Database
 - Standard QC Reports



select mode ...



and measure

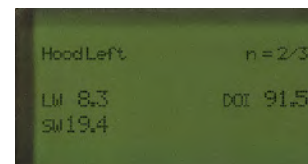

Always ready

The orange peel meter is operated with a rechargeable battery pack (Li-Ion). The docking station automatically charges the battery pack and transfers the measured data to the PC. Optionally, the wave-scan II can be operated with 3 standard mignon alkaline or rechargeable batteries - good for 1000 readings.



Ordering Information

Cat. No.	Description
4846	wave-scan II

Comes complete with:

Orange peel meter with protective cover,
Certificate,
Checking tile,
Software smart-process with 2 licenses for download
Docking station with USB-cable,
2 rechargeable Li-Ion battery packs,
Battery holder for AA alkaline batteries,
3 Batteries, Operating manual,
Carrying case,
Training

System requirements:

Operating system: Windows 7 SP1, 8.1 or 10
Microsoft® .NET Framework 4.5.2
Hardware: Core 2 Duo, 2.5 GHz; i7 recommended,
or equivalent Memory: 4 GB RAM, 8 GB recommended
Hard-disk capacity: 2 GB during installation
Monitor resolution: 1280 x 1024 pixel or higher
Interface: free USB-port

Technical Specifications

Application	
High Gloss Surfaces	du < 40, linear range
Structure Spectrum	
du	< 0.1 mm
Wa	0.1 to 0.3 mm
Wb	0.3 to 1 mm
Wc	1 to 3 mm
Wd	3 to 10 mm
We	10 to 30 mm
Repeatability ¹	4% or > 0.4
Reproducibility ¹	6% or > 0.6
Object Curvature	radius > 500 mm
Min. Sample Size	35 mm x 150 mm
Scan Length	5 / 10 / 20 cm
Resolution	375 points/cm
Memory	1500 readings
Interface	USB port
Languages	English, French, German, Italian, Japanese, Portuguese, Spanish
Light Source	Laser diode
Laser Energy	< 1 mW (Laser class 2)
Dimensions	150 x 110 x 55 mm (5.9 x 4.3 x 2.2 in.)
Weight	650 g (1.5 lbs)
Power Supply	rechargeable battery pack or 3 AA alkaline batteries approx. 1000 readings
Temperature Range	operation: +10°C to 40°C (+50°F to 104°F) storage: 0°C to 60°C (+32°F to 140°F)
Rel. Humidity	up to 85% at 35°C (95°F), non-condensing

¹Standard deviation

Training for wave-scan II

BYK-Gardner offers you more than just an instrument. We assist you in operating the wave-scan system and understanding your appearance readings. As a result you will be able to use the orange peel meter to save time and money and at the same time improve your quality. Therefore, the instrument comes with a one day training course including:

1. Orange Peel and DOI Theory

- Visual perception and instrumental measurement of Orange Peel and DOI
- Data interpretation: How can the structure spectrum be used to optimize process and material parameters

2. Operation and Software Training

- Set-up of an "Organizer" to create a routine measurement procedure
- Programming of the instrument with "organizer" and measurement of several samples
- Direct data transfer to Excel for documentation of individual readings
- Data transfer to smart-chart software and saving in a database for routine QC

- Data analysis using standard QC-reports:
 - Summary by lines to show at one glance how various colors are running at different paint lines
 - Trend chart to show how specified zones perform over a defined time range
 - SPC-chart for daily process control of your critical colors and highrunners: xR-chart
 - Zone profile for trouble shooting using the structure spectrum

Create your own reports in Excel®

- Transfer data from the database to Excel
- Pivot function to define layout in Excel
- The training can be performed in one day or two half days. It is recommended to split the training into two half days:

Day 1: Theory and basic operation (set-up organizer, taking readings and saving data in a database)

Day 2: 3-4 weeks later to ensure readings were taken and saved in a database. Data analysis and standard QC reports can be explained using customer specific data.



Ordering Information

Cat. No.	Description
4847	Checking tile wave-scan II
4841	Docking Station, for 4840/4846
4842	Battery Pack, for 4840/4846
4831	Software smart-chart

Accessories

Replacement - please contact your local service department for replacement of your checking tile.

Incl. USB interface cable and recharger 100 - 240 V self adapting

Rechargeable battery for automatic charge in docking station

Software for professional analysis and documentation of color and appearance



micro-wave-scan

Orange Peel and DOI measurement

Now you can measure Orange Peel and DOI on small and curved surfaces: Automotive add-on parts - like bumpers, gas tank doors, mirror housings, door handles, decorative trim or motorcycle parts.

...for curved and small parts

- Curvature > 300 mm
- Minimum sample size: 25 mm x 40 mm
- Selectable scan length 20, 10 or even 5 cm
- Measurement area: 4 mm x scan length
- DOI measurement possible without scanning the surface
- Good correlation to wave-scan DOI, the appearance standard in the automotive industry

Fits in the palm of your hand

- Small and light weight, easy to operate with one hand
- New scroll wheel to select functions and operate button to take readings
- Large, multilingual display: complete statistics and name input directly at the orange peel meter
- Storage of 2000 readings in selectable memories
- Docking station for recharging battery pack and data transfer to PC
- Rechargeable battery pack or standard mignon batteries can be used
- smart-chart software for professional analysis, documentation and data management

Objective and reliable appearance data

- Structure spectrum gives detailed information about various structure size
- High correlation to the visual perception
- Cause of appearance changes can be analyzed
- DOI - Distinctness of Image: objective measurement independent of paint system and curvature

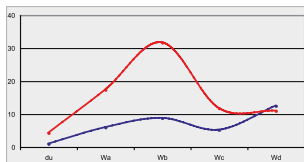

select mode ...



and measure



Always ready

The micro-wave-scan is operated with a rechargeable battery pack (Li-Ion). The docking station automatically charges the battery pack and transfers the measured data to the PC. Optionally, the orange peel meter can be operated with 2 standard AA alkaline or rechargeable batteries - good for 1000 readings.



Technical Specifications

Application	
High Gloss Surfaces	du < 40, linear range
Structure Spectrum	du: < 0.1 mm Wa: 0.1 - 0.3 mm Wb: 0.3 - 1 mm Wc: 1 - 3 mm Wd: 3 - 10 mm
Scan length/	20 cm: du, Wa...Wd, L, S, DOI
Measurement scales	10 cm: du, Wa...Wd, L, S, DOI 5 cm: du, Wa...Wd, L, S, DOI 0 cm: du, Wa, Wb, DOI
Repeatability¹	8% or > 0.8
Reproducibility¹	12% or > 1.2
Object Curvature	radius > 300 mm
Min. Sample Size	25 mm x 40 mm
Measurement Area	4 mm x scan length
Scan Length	5 / 10 / 20 cm
Resolution	375 points/cm
Memory	2000 readings
Interface	USB port
Languages	English, French, German, Italian, Japanese, Portuguese, Spanish
Light Source	Laser diode, LED
Laser Energy	< 1 mW (Laser class 2)
Dimensions	70 x 120 x 40 mm (2.7 x 4.7 x 1.6 in)
Weight	250 g (0.6 lbs)
Power Supply	rechargeable battery pack or 2 AA batteries, approx. 1000 readings
Temperature Range	operation: +10°C - 40°C (+50°F - 104°F) storage: 0°C - 60°C (+32°F - 140°F)
Relative Humidity	up to 85% at 35°C (95°F)

¹ Standard deviation



Ordering Information

Cat. No.	Description
4824	micro-wave-scan

Comes complete with:

Orange peel meter with protective cap,
Certificate,
Checking tile,
Software smart-process with 2 licenses for download,
Docking station and USB-cable,
2 rechargeable Li-Ion battery packs,
Battery holder for AA batteries,
2 Batteries, Operating manual,
Carrying case and belt case,
Training

System requirements:

Operating system: Windows 7 SP1, 8.1 or 10
Microsoft® .NET Framework 4.5.2
Hardware: Core 2 Duo, 2.5 GHz; i7, recommended, or equivalent
Memory: 4 GB RAM, 8 GB recommended
Hard-disk capacity: 2 GB during installation
Monitor resolution: 1280 x 1024 pixel or higher
Interface: free USB-port

Training for micro-wave-scan

BYK-Gardner offers you more than just an instrument. We assist you in operation of the micro-wave-scan system and understanding your appearance readings. As a result you will be able to use the orange peel meter to save time and money and at the same time improve your quality. Therefore, the instrument comes with a one day training course including:

1. Orange Peel and DOI Theory

- Visual perception and instrumental measurement of Orange Peel and DOI
- Data interpretation: How can the structure spectrum be used to optimize process / material parameters

2. Operation and Software Training

- Set-up of an "organizer" to create a routine measurement procedure
- Programming of the instrument with "organizer" and measurement of several samples
- Direct data transfer to Excel for documentation of individual readings
- Data transfer to smart-chart software and saving in a database for routine QC
- Data analysis using standard QC-reports:
 - Summary by lines to show at one glance how various colors are running at different paint lines
 - Trend chart to show how specified zones perform over a defined time range
 - SPC-chart for daily process control of your critical colors and highrunners: xR-chart
 - Zone profile for trouble shooting using the structure spectrum



- Create your own reports in Excel
 - Transfer data from the database to Excel
 - Pivot function to define layout in Excel

The training can be performed in one day or two half days. It is recommended to split the training into two half days:

- Day 1: Theory and basic operation (set-up organizer, taking readings and saving data in a database)
- Day 2: 3-4 weeks later to ensure readings were taken and saved in a database. Data analysis and standard QC reports can be explained using customer specific data.



Ordering Information

Cat. No.	Description
4857	Docking Station, for 4824
4829	Checking Tile, for 4824
4827	Battery Pack micro-wave-scan
4831	Software smart-chart



Accessories

Incl. USB cable and recharger 100 - 240 V self adapting
Replacement - please contact your local service department for replacement of your checking tile.
Rechargeable battery for automatic charge in docking station
Software for analysis and professional documentation in Excel®

wave-scan ROBOTIC

Automatic appearance control of topcoat finish at the line

A stable running process is the key for uniform and consistent quality. Therefore, orange peel and DOI need to be measured on a routine basis in the production process and the measurement results shared with add-on suppliers. The new wave-scan ROBOTIC allows automated appearance control as it is mounted on a robotic arm. The robotic system ensures measurement on the same area and a high number of measured car bodies.

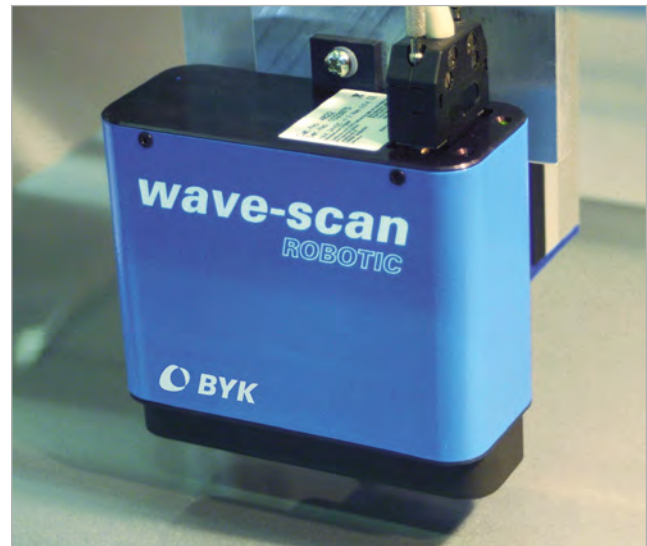

Non-contact measurement

- Distance to surface 15 ± 2 mm
- Angle to perpendicular $\pm 2^\circ$
- Curvature > 500 mm radius
- Scan speed 50 to 150 mm/sec.
- Small and light weight



Objective and reliable appearance data

Excellent correlation to wave-scan DOI, the appearance standard in the automotive industry

- Structure spectrum gives detailed information about the surface quality
- Cause of appearance changes can be analyzed
- Orange Peel, DOI and customer specific scales available

Stable process means consistent quality

- Automated appearance control provides complete and representative data for statistical process control
- wave-scan ROBOTIC builds up a valuable database for systematic process analysis and optimization

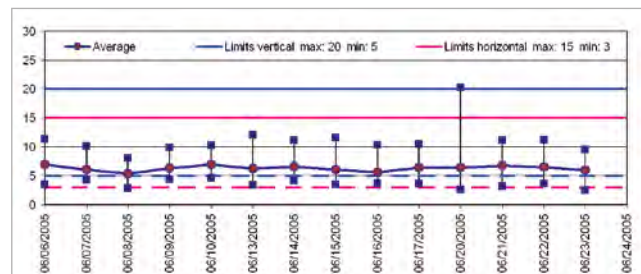

Training for wave-scan ROBOTIC

BYK-Gardner offers you more than just an instrument, we assist you in operating the wave-scan system. Therefore, the orange peel meter comes with a two day training course including:

- Orange Peel & DOI: Theory and data interpretation.
- Support in integrating wave-scan ROBOTIC sensor into automated measurement system
- Data analysis using standard QC-reports including SPC-charts



Ordering Information

Cat. No.	Description
4822	wave-scan ROBOTIC

Comes complete with:

Orange peel meter,
Certificate,
Checking tile,
BYKWARE smart-chart software,
Communication software,
Installation kit,
Operating manual,
Carrying case,
Training

Hardware requirements:

Operating system: Windows 7 SP1, 8.1 or 10
Microsoft® .NET Framework 4.5.2
Hardware: Core 2 Duo, 2.5 GHz; i7 recommended, or equivalent
Memory: 4 GB RAM, 8 GB recommended
Hard-disk capacity: 2 GB during installation
Monitor resolution: 1280 x 1024 pixel or higher
Disk drive: CD-ROM or DVD drive



Technical Specifications

Application	
High Gloss Surfaces	du < 40, linear range
Structure Spectrum	du: < 0.1 mm Wa: 0.1 to 0.3 mm Wb: 0.3 to 1 mm Wc: 1 to 3 mm Wd: 3 to 10 mm We: 10 to 30 mm
Repeatability¹	4% or < 0.4
Reproducibility¹	6% or > 0.6
Resolution	375 points/cm
Distance to Surface	15 ± 2 mm
Angle to Surface	perpendicular ± 2°
Object Curvature	radius > 500 mm
Min. Sample Size	35 mm x 150 mm
Scan Length	5 / 10 / 20 cm
Scan Speed	50 to 150 mm/sec
Memory	100 readings
Light Source	Laser diode, LED
Laser Energy	< 1 mW (Laser class 2)
Dimensions	112 x 115 x 60 mm (4.4 x 4.5 x 2.4 in)
Weight	520 g (1.2 lbs)
Power Supply	external power supply 24 V DC, max. 0.5 A
Interface	RS-422
Robotic requirements	Vibration-free operation
Temperature Range	operation: +10°C to 40°C (+50°F to 104°F) storage: 0°C to 60°C (+32°F to 140°F)
Rel. Humidity	up to 85% at 35°C (95°F) non-condensing
Rel. Humidity	up to 85% at 35°C (95°F) non-condensing

¹ Standard deviation



Ordering Information

Cat. No.	Description
4833	Checking Tile, for 4822
4831	BYKWARE smart-process

Accessories

Replacement - please contact your local service department for replacement of your checking tile.

Process QC Software for wave-scan, cloud-runner, BYK-mac i

smart-process

Color and Appearance data in one QC management system

All critical color and appearance parameters can be saved and analyzed with one software package, smart-process.

- Multi-angle color and effect control with BYK-mac i
- Orange peel and Distinctness-of-Image measurement with wave-scan
- Objective mottling analysis with the new cloud-runner

It is smart in more than one way. 6 different apps let you set up a state-of-the-art color & appearance management system.

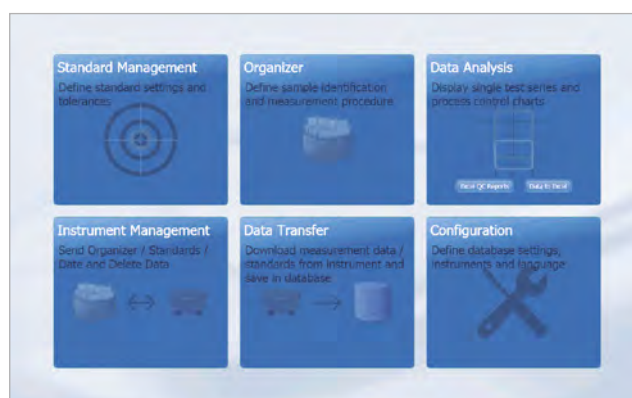

Standard Management – manage an unlimited number of colors

smart-process includes powerful standard management for defining all essential color and appearance control parameters with Pass / Fail tolerances. Customer specific color and appearance scales for major automotive makers are already predefined and ensure color and appearance control according to their internal specifications.

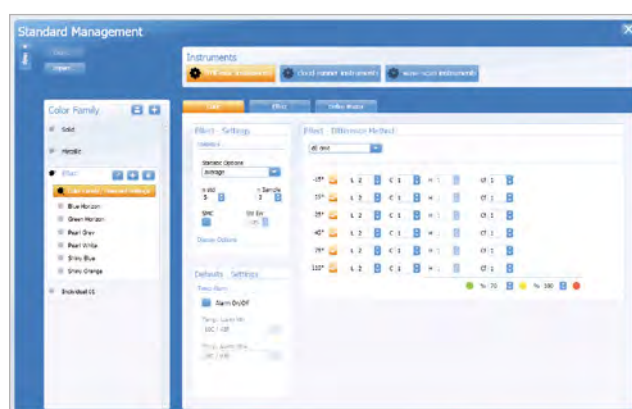

Digital Standard – guarantees a seamless workflow

Thanks to the outstanding inter-instrument agreement of BYK-mac i - proven by all automotive makers and unsurpassed in the industry - smart-process enables you to use "digital standards" on a global basis with your entire supply chain. Export and import your color standards in xml file format and send them by email to your supply chain. Thus, color control data are reliable and communication among all parties is seamless and efficient.

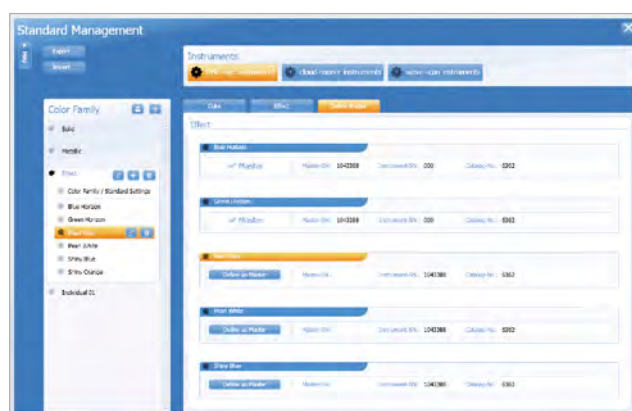

Organizer Set-up – standardized measurement and sample labeling

smart-process offers set-up of Organizers for clear sample identification and a menu guided operation on the instrument. Product schematics help to define specific sampling procedures. The entered parameters can be used for filtering the measured data saved in the database. Typical identifiers are model, color or product ID - smart-process is open for your specific needs.



Data Analysis – green light for shipping

Data analysis was never easier. The data are saved in a SQL database which allows handling of large data sets over a long time period. See all your test series at once based on your specific criteria. Select filter criteria, such as a certain time range, a specific color and all “green” or “yellow” or “red” test series for further analysis.

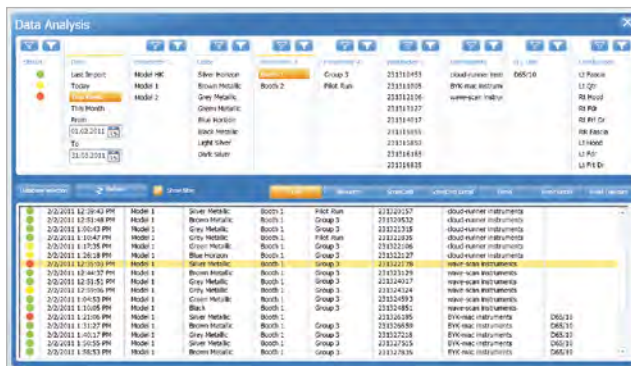

Data analysis – Detailed measurement reports

View and open the measurement data of a single test series with a click. The product schematic quickly shows you where the “problem areas” are. The data is also displayed in an easy-to-read data table highlighting the measurements out of specifications. Additionally to the individual test results per check zone, the averages of groups (horizontal or verticals) are calculated and shown on top of the report. For color harmony analysis the difference of each check zone to the master standard and the differences between “panel matches” as defined in the organizer are displayed.

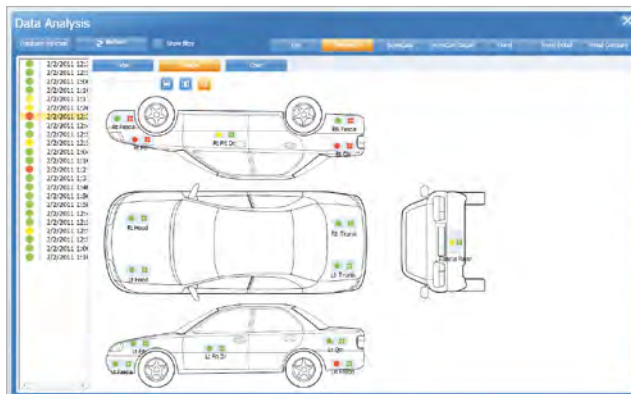

Monitor your process and document stability

Innovative data analysis reports feature scorecards with drill-down functionality as well as trend reports for all measured parameters. They are so easy to set up that statistical analysis actually becomes a fun project. And the data is documented and analyzed all together for color and appearance. Valuable time for data crunching will be saved and lengthy discussions analyzing the data will no longer be necessary.

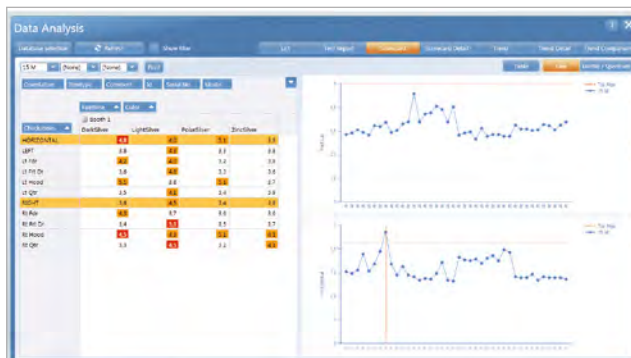

wave-scan Balance Chart

The Balance Chart shows all important info in one report:

- Customer specifications
- Balance Chart for visual correlation
- Structure Spectrum for optimization

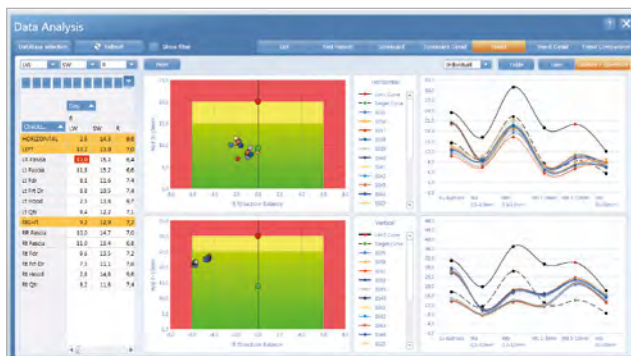

BYK-mac i Color Harmony and Process Control Chart

Lab-Scatter Graph

This standard report shows at a glance whether all parts are within specification. One graph per angle is shown and different tolerance models (e.g. CMC, DIN 6175-2) can be selected.

Effect Graph

Similar to the Lab-scatter graph, this chart easily shows whether effect differences are within tolerance. One graph per sparkle angle and graininess is displayed. Tolerances can be set to your specific requirements.

Color & Effect Travel by Sample

...the ideal tool to show how individual measurement areas or colors perform per measurement angle. In combination with a graph for sparkle and graininess values, total color impression can be easily controlled.

cloud-runner Mottle Chart

Customer relevant limits for mottling can be defined by setting limits for the Mottling indices. The measured data is displayed in a two-dimensional chart with red - yellow - green ranges for easy process control. In addition, the mottle spectrum gives more detailed information for optimization and trouble shooting.

With smart-process, you'll know where you are, where you're going, and how to get there.

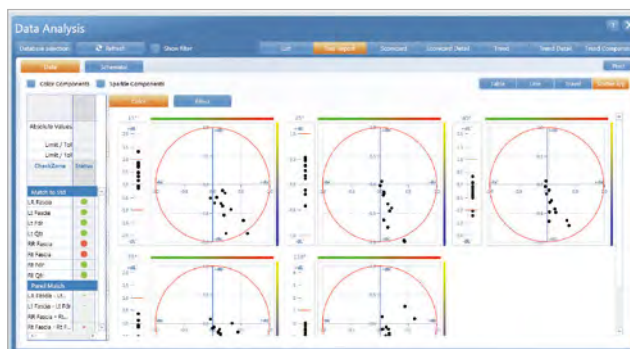

Ordering Information

Cat. No.	Description
4831	smart-process

Comes complete with:

Software with 2 licenses for download

Note: smart-process licence fee for more than two installations is quantity dependent. Please contact your local BYK-Gardner representative.

System Requirements:

Operating system: Windows 7 SP1, 8.1 or 10

Microsoft® .NET Framework 4.5.2

Hardware: Core 2 Duo, 2.5 GHz; i7 recommended,

or equivalent Memory: 4 GB RAM, 8 GB recommended

Hard-disk capacity: 2 GB during installation

Monitor resolution: 1280 x 1024 pixel or higher

Interface: free USB-port

Technical Specifications

	Process QC Software for BYK-mac i, wave-scan and cloud-runner
Instruments	wave-scan dual, wave-scan II, micro-wave-scan, BYK-mac i, BYK-mac i COLOR, cloud-runner
Export/Import	Color Standards (.xml format) Organizer (.xml format)
Database format	SQL Server Compact
Languages	Chinese, English, French, German, Italian, Japanese, Spanish

Color and Gloss Control of Automotive Interior Parts

The S-Family with close tolerances for toughest QC specs

How many hours do you spend in your car? Most likely you will say "many". Thus, the interior design is getting more and more important in your purchasing decision.

A big challenge for every car manufacturer is to achieve a "feeling" of high value and at the same time minimize cost. Therefore, a variety of materials are used and need to be harmonized. The design group specifies the color, gloss and grain. Once a new color or material or process is approved, a new "style" is born – ready for implementation. At this point the supplier quality group takes ownership and starts working with various part suppliers. As a starting point master standard plaques of the new colors are manufactured with usually a flat and several grained areas. These are sent to the suppliers as their target to achieve with actual production parts.

As the master plaques and final parts are often made of different materials the suppliers work closely with the car maker. At the end the final approval is given on a production part. This production part now becomes the standard for the supplier. In order to guarantee a uniform look among the various materials very tight tolerances are specified.

Typical tolerances

Color: ΔL^* , Δa^* , Δb^* = +/- 0.5
60° Gloss: < 5 GU +/- 0.3 to 0.5

It is impossible to visually assess, if color and gloss are within these very tight tolerances. Only testing instruments with excellent precision will be able to objectively control the production.

New color and gloss instruments with tighter technical specs

BYK-Gardner succeeded in offering a new line of color and gloss meters with improved technical performance for 60° gloss in the low gloss range (0-10 GU). The excellent repeatability of +/- 0.1 can be guaranteed due to our patented calibration procedure for the new micro-gloss and spectro-guide families.

How can a gloss or color tolerance of +/- 0.5 be meaningful?

Instead of working with absolute color or gloss numbers the supplier production QC needs to be based on the signed-off part and only the differences are checked. This procedure eliminates the reproducibility error as color and gloss are measured relatively on the same type of material and same surface. Therefore, a difference of 0.3 gloss units from part to part can be considered as a significant difference.

In addition to the improved technical performance the micro-gloss and spectro-guide families offer you unique benefits to always guarantee precise results:

- › Long-term stable calibration – needed only every three months. Guaranteed even when the temperature or humidity changes.
- › Temperature stable color and gloss data between 10 °C – 40 °C
- › 10 years warranty on the light source



Introduction

Mottling

Mottling is an undesirable defect which can occur with effect coatings - it is most obvious on light metallic finishes. The total color impression shows irregular areas of lightness variations. These "patches" are usually visually evaluated, described as a mottling effect. Some also feel that it reminds them of clouds. This effect is especially noticeable on large body panels. It can be caused by the coating formulation, as well as variations in the application process. For example, disorientation of the metallic flakes or film thickness variations of the basecoat can lead to various mottle sizes resulting in a non-uniform appearance.

Orientation Clouds



Disorientation influenced by wetting behaviour, rheology additive or application

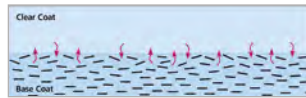

Strike in effect: disorientation by interaction between clear coat and basecoat

Thickness / Hiding Clouds

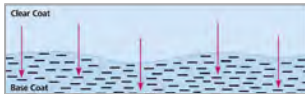

Thickness variations result in poor hiding

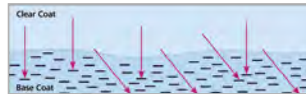

Thickness variations result in partial hiding at a grazing angle

MOTTLING



The visual perception of mottling is dependent on the viewing distance: Large mottles can be seen in far distance evaluation, while small mottles are more noticeable in close up evaluation. The visual evaluation of mottling is very subjective, as it depends on the illumination conditions, the observing distance and the viewing angle.

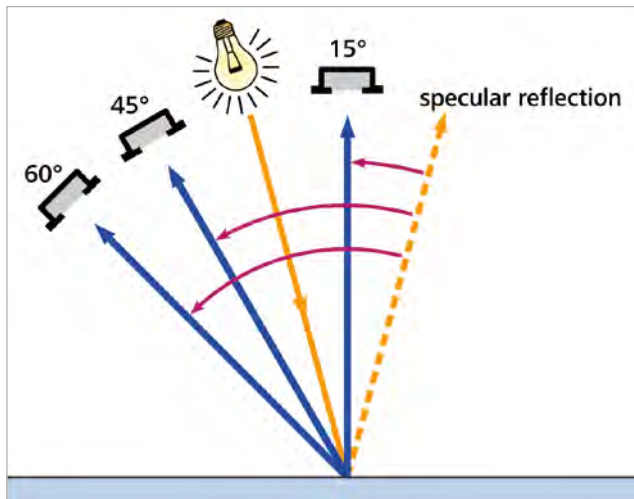
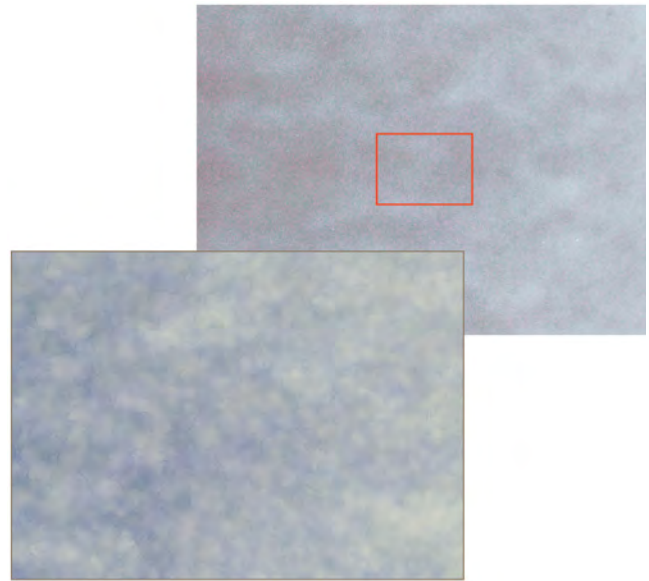

cloud-runner: measurement principle

Simulation of visual perception

In order to objectively evaluate mottling, it is necessary to measure lightness variations over a large sample area and under different detection angles.

The cloud-runner optically scans the surface and measures the lightness variations. The specimen is illuminated with a white light LED at a 15° angle and the lightness is detected under three viewing angles to simulate visual evaluation under different observing conditions: 15°, 45° and 60° measured from the specular reflection.

The mottling meter is rolled across the surface for a defined distance of 10 to 100 cm and measures the lightness variations point by point.



Mottle Size

Md	6 -13 mm
Me	11 -24 mm
Mf	19 - 42 mm
Mg	33 - 72 mm
Mh	57 - 126 mm
Mi	100 - 200 mm

The measurement signal is divided via mathematical filter functions into 6 different size ranges and a rating value is calculated for each angle and mottle size. The higher the value is, the more visible the mottling effect.

The measured values are displayed in a graph showing the mottle size on the X-axis and the rating value on the Y-axis. Thus, target values for small and large mottle sizes can be established for paint batch approval as well as process control.

Interpretation of measurement data

Example: Light Blue Metallic

In this example the influence of the observing angle is quite significant. Visually medium to large size mottles are most obvious at a head-on viewing when the sample appears lighter, while at flatter angles the mottling is no longer visible.

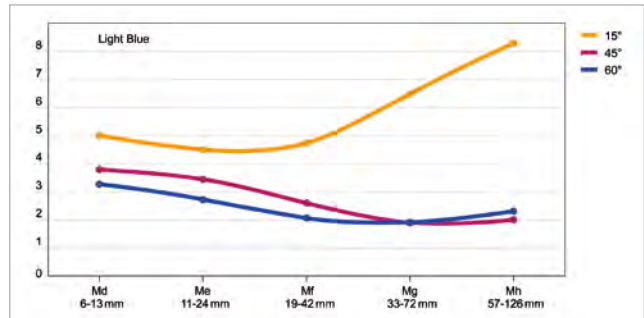

Example: Silver Metallic

Horizontal and vertical parts were visually evaluated and measured. The horizontal areas showed a high amount of medium size mottles, while the vertical areas were visually acceptable. The cloud-runner measured high Mg-values at all three angles on the horizontal areas and considerably lower readings on the vertical areas.

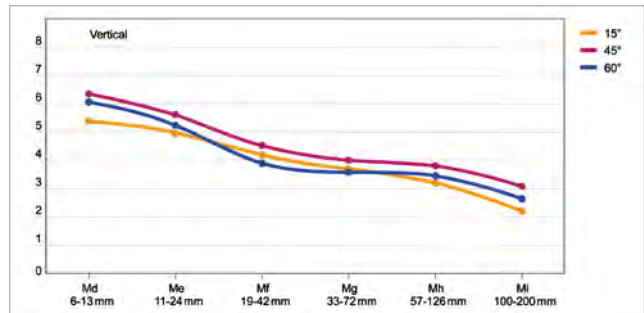
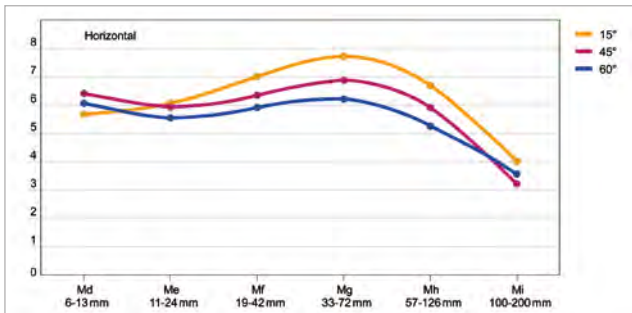

cloud-runner

Control and guarantee a uniform finish – no more mottling!

Mottling disturbs the overall color harmony of effect finishes. These irregular lightness variations can now be objectively measured with BYK-Gardner's newest innovation: the cloud-runner simulates visual evaluation under different observing angles and characterizes clouds / mottles by their size and visibility.

Objective and reliable values for QC and trouble shooting

- Small to large mottles are measured under three observing angles
- Scan length can be varied from 10 to 100 cm
- Objective measurement results independent of color and curvature

Ideal tool for the production line

- Small and light weight - easy to handle
- For flat and curved areas, radius > 50 cm
- Easy, menu guided operation via scroll wheel and large, multilingual display
- Full statistics with ability to save in selectable memories
- Large memory for 1000 readings
- USB port for data transfer to PC
- smart-chart software:
 - Organizer files for sample id
 - Data management with SQL Database
 - Standard QC Report



select mode ...



and measure

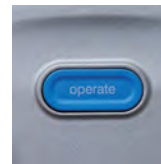

	Md	Me	Mf
15°	5.3	3.7	4.1
45°	7.0	5.7	4.6
60°	5.2	4.4	3.4



Always ready

The mottle meter is operated with a rechargeable battery pack (Li-Ion). The docking station automatically charges the battery pack and transfers the measured data to the PC.



Ordering Information

Cat. No.	Description
6350	cloud-runner

Comes complete with:

Mottling meter with protective cover
 Certificate
 Checking tile
 Software smart-process with 2 licenses for download
 Docking station with USB-cable
 2 rechargeable Li-Ion battery packs
 Operating manual
 Carrying case
 Training

System requirements:

Operating system: Windows 7 SP1, 8.1 or 10
 Microsoft® .NET Framework 4.5.2
 Hardware: Core 2 Duo, 2.5 GHz; i7 recommended, or equivalent
 Memory: 4 GB RAM, 8 GB recommended
 Hard-disk capacity: 2 GB during installation
 Monitor resolution: 1280 x 1024 pixel or higher
 Interface: free USB-port

Technical Specifications

Cloud Size	
Md	6 to 13mm
Me	11 to 24 mm
Mf	19 to 42 mm
Mg	33 to 72 mm
Mh	57 to 126 mm
Mi	100 to 200 mm
Repeatability¹	5% or > 0.5
Reproducibility¹	8% or > 0.8
Object Curvature	radius > 500 mm
Scan Length	10 to 100 cm, selectable in 1cm steps
Resolution	25 points/cm
Measuring Time	< 4 sec.
Memory	1000 readings
Interface	USB port
Languages	English, French, German, Italian, Japanese, Portuguese, Spanish
Light Source	White Power LED
Dimensions	150 x 110 x 55 mm (5.9 x 4.3 x 2.2 in.)
Weight	650 g (1.5 lbs)
Power Supply	rechargeable battery pack, approx. 1500 readings
Temperature Range	operation: +10°C to 40°C (+50°F to 104°F) storage: 0°C to 60°C (+32°F to 140°F)
Rel. Humidity	up to 85% at 35°C (95°F), non-condensing

¹Standard deviation

Training for cloud-runner

BYK-Gardner offers you more than just an instrument. We assist you in operating the cloud-runner system and understanding your mottling readings. As a result you will be able to use the mottling meter to save time and money and at the same time improve your quality. Therefore, the instrument comes with a one day training course including:

1. Mottling Theory

- Visual perception and instrumental measurement of Mottling / Cloudiness
- Data interpretation: How can the readings be used to optimize process and material parameters

2. Operation and Software Training

- Set-up of an "Organizer" to create a routine measurement procedure
- Programming of the instrument with "organizer" and measurement of several samples
- Direct data transfer to Excel for documentation of individual readings
- Data transfer to smart-chart software and saving in a database for routine QC
- Data analysis

The training can be performed in one day or two half days. It is recommended to split the training into two half days:

Day 1: Theory and basic operation (set-up organizer, taking readings and saving data in a database)

Day 2: 3-4 weeks later to ensure readings were taken and saved in a database. Data analysis and standard QC reports can be explained using customer specific data.



Ordering Information

Cat. No.	Description
6353	Checking Tile cloud-runner
6351	Docking Station cloud-runner
6349	Battery Pack cloud-runner
4831	Software smart-chart

Accessories

Replacement - please contact your local service department for replacement of your checking tile.
Incl. USB interface cable and recharger 100 - 240 V self adapting
Rechargeable battery for automatic charge in docking station
Software for professional analysis and documentation of color and appearance



smart-process

Color and Appearance data in one QC management system

All critical color and appearance parameters can be saved and analyzed with one software package, smart-process.

- Multi-angle color and effect control with BYK-mac i
- Orange peel and Distinctness-of-Image measurement with wave-scan
- Objective mottling analysis with the new cloud-runner

It is smart in more than one way. 6 different apps let you set up a state-of-the art color & appearance management system.

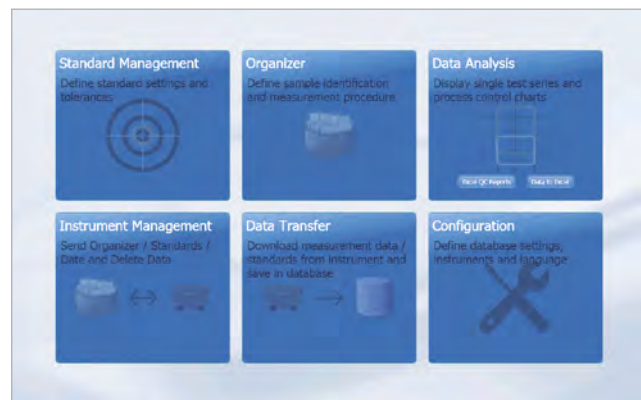

Standard Management – manage an unlimited number of colors

smart-process includes powerful standard management for defining all essential color and appearance control parameters with Pass / Fail tolerances. Customer specific color and appearance scales for major automotive makers are already predefined and ensure color and appearance control according to their internal specifications.

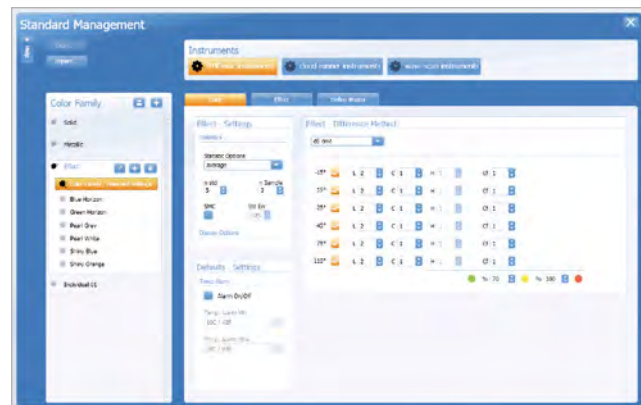

Digital Standard – guarantees a seamless workflow

Thanks to the outstanding inter-instrument agreement of BYK-mac i - proven by all automotive makers and unsurpassed in the industry - smart-process enables you to use “digital standards” on a global basis with your entire supply chain. Export and import your color standards in xml file format and send them by email to your supply chain. Thus, color control data are reliable and communication among all parties is seamless and efficient.

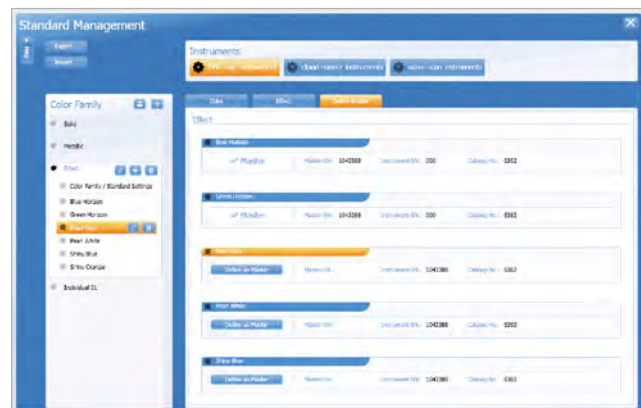

Organizer Set-up – standardized measurement and sample labeling

smart-process offers set-up of Organizers for clear sample identification and a menu guided operation on the instrument. Product schematics help to define specific sampling procedures. The entered parameters can be used for filtering the measured data saved in the database. Typical identifiers are model, color or product ID - smart-process is open for your specific needs.

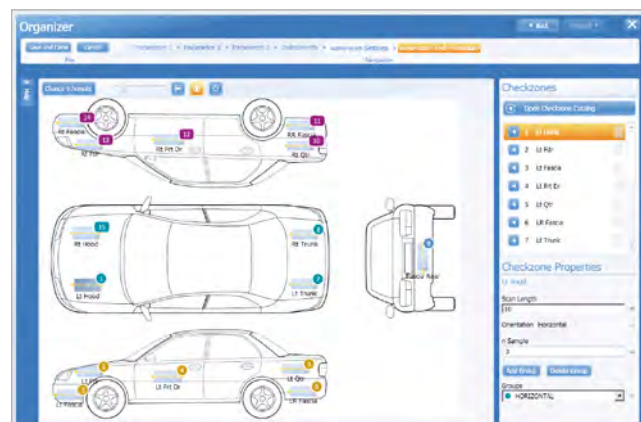

Data Analysis – green light for shipping

Data analysis was never easier. The data are saved in a SQL database which allows handling of large data sets over a long time period. See all your test series at once based on your specific criteria. Select filter criteria, such as a certain time range, a specific color and all “green” or “yellow” or “red” test series for further analysis.

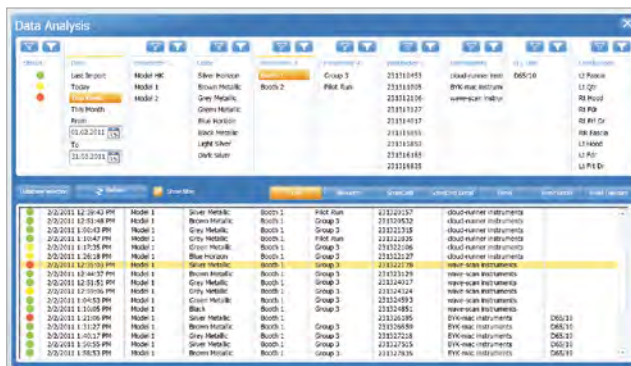

Data analysis – Detailed measurement reports

View and open the measurement data of a single test series with a click. The product schematic quickly shows you where the “problem areas” are. The data is also displayed in an easy-to-read data table highlighting the measurements out of specifications. Additionally to the individual test results per check zone, the averages of groups (horizontal or verticals) are calculated and shown on top of the report. For color harmony analysis the difference of each check zone to the master standard and the differences between “panel matches” as defined in the organizer are displayed.

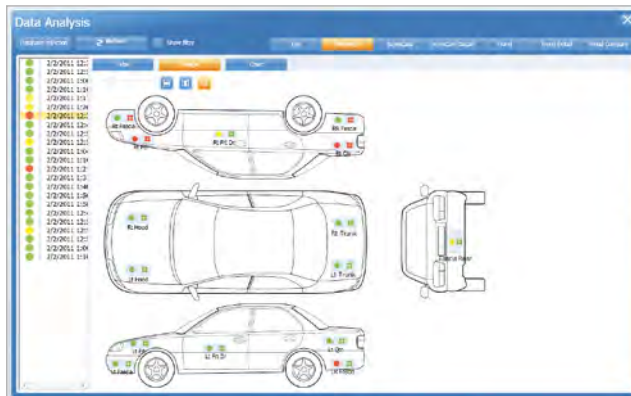

Monitor your process and document stability

Innovative data analysis reports feature scorecards with drill-down functionality as well as trend reports for all measured parameters. They are so easy to set up that statistical analysis actually becomes a fun project. And the data is documented and analyzed all together for color and appearance. Valuable time for data crunching will be saved and lengthy discussions analyzing the data will no longer be necessary.

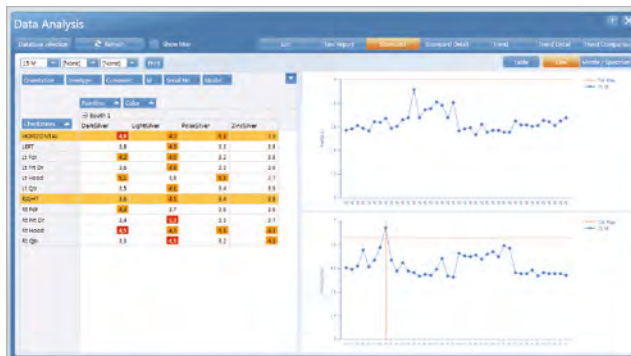

wave-scan Balance Chart

The Balance Chart shows all important info in one report:

- Customer specifications
- Balance Chart for visual correlation
- Structure Spectrum for optimization

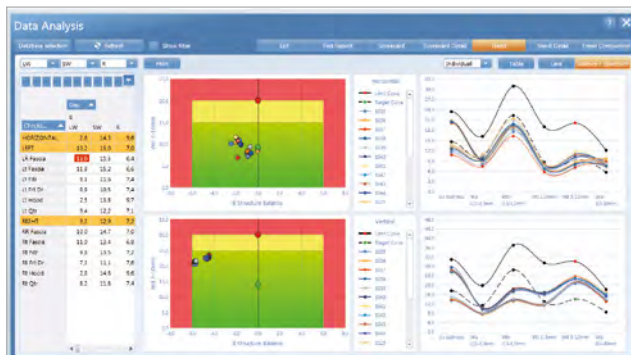

BYK-mac i Color Harmony and Process Control Chart

Lab-Scatter Graph

This standard report shows at a glance whether all parts are within specification. One graph per angle is shown and different tolerance models (e.g. CMC, DIN 6175-2) can be selected.

Effect Graph

Similar to the Lab-scatter graph, this chart easily shows whether effect differences are within tolerance. One graph per sparkle angle and graininess is displayed. Tolerances can be set to your specific requirements.

Color & Effect Travel by Sample

...the ideal tool to show how individual measurement areas or colors perform per measurement angle. In combination with a graph for sparkle and graininess values, total color impression can be easily controlled.

cloud-runner Mottle Chart

Customer relevant limits for mottling can be defined by setting limits for the Mottling indices. The measured data is displayed in a two-dimensional chart with red - yellow - green ranges for easy process control. In addition, the mottle spectrum gives more detailed information for optimization and trouble shooting.

With smart-process, you'll know where you are, where you're going, and how to get there.

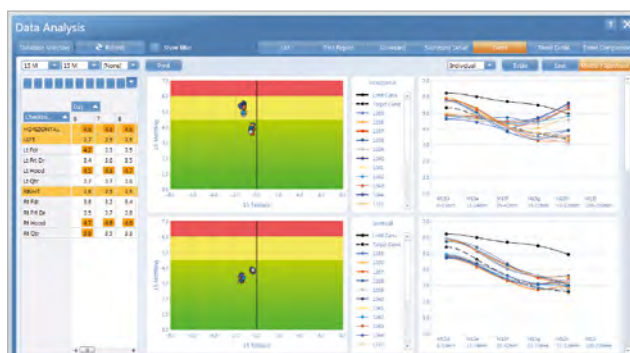
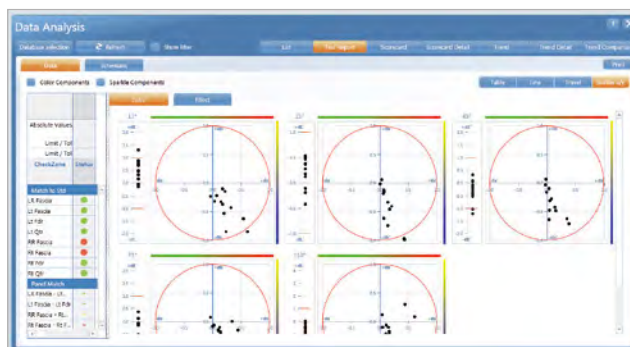

Ordering Information

Cat. No.	Description
4831	smart-process

Comes complete with: Software with 2 licenses for download

Note: smart-process licence fee for more than two installations is quantity dependent. Please contact your local BYK-Gardner representative.

System Requirements:

Operating system: Windows 7 SP1, 8.1 or 10

Microsoft® .NET Framework 4.5.2

Hardware: Core 2 Duo, 2.5 GHz; i7 recommended,

or equivalent Memory: 4 GB RAM, 8 GB recommended

Hard-disk capacity: 2 GB during installation

Monitor resolution: 1280 x 1024 pixel or higher

Interface: free USB-port

Technical Specifications

Process QC Software for BYK-mac i, wave-scan and cloud-runner

Instruments wave-scan dual, wave-scan II, micro-wave-scan, BYK-mac i, BYK-mac i COLOR, cloud-runner

Export/Import Color Standards (.xml format)
Organizer (.xml format)

Database format SQL Server Compact

Languages Chinese, English, French, German, Italian, Japanese, Spanish

Uniform Color and Appearance of Exterior Automotive Finishes

The paint finish of a car has to meet two main requirements: protect the vehicle from weathering influences (e.g. corrosion, loss of gloss) or other mechanical impacts (e.g. car wash and chip resistance) and, of course make the car visually appealing. Eye catching finishes should not only have a “beautiful” color, but look like a mirror – “high gloss and perfectly smooth”. Uniformity is especially important. Any color and appearance differences between car body and add-on parts will be most noticeable and be associated with lower quality, or could even result in costly warranty complaints.

Therefore, target values with tolerances for color and appearance are defined by the automotive OEM makers. Meeting these target values is a challenging task for everybody in the supply chain, as color and appearance is not only a multi-dimensional phenomena, but also can be influenced by a variety of material, substrate and process parameters.

Orange peel and DOI control with wave-scan family

The appearance of a finish can be described by its brilliance and “smoothness”, also referred to as DOI (Distinctness of Image) and Orange Peel. For years the BYK-Gardner wave-scan family has been used as the standard to objectively quantify appearance of painted body and off-line painted parts by all major car, truck, motorcycle, boat and yacht companies.

Depending on the OEM different target values and appearance scales have been developed over the years. These company specific scales are an objective check to ensure company specifications are met, and eliminate heated discussions between automotive producers and their suppliers.

In order to ensure harmony as well as brilliant and smooth appearance, long and short waviness scales should not be evaluated separately and independently optimized. Therefore, a “balance” between short waves and long wave measurement scales is essential.

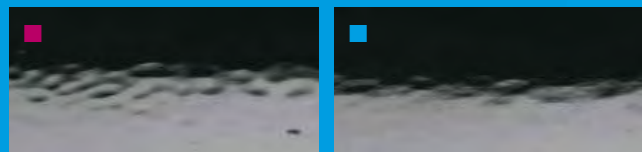
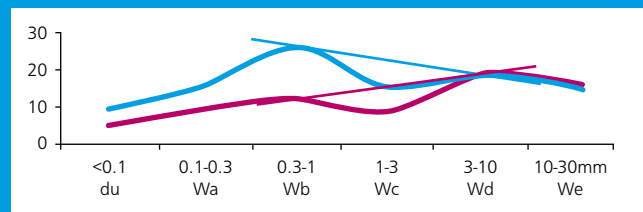

A decrease of short wave value will result in a more brilliant appearance making longer waves more visible.

Additionally, the wave-scan measurement data can be used for trouble shooting to improve quality.

Dullness is too high	Clear coat looks milky Very fine textures
Wa is too high	Substrate influence Dry spray of clear coat
Wb is too high	Substrate influence
Wc is too high	Insufficient amount of clear coat Very rough substrate
Wd is too high	Insufficient amount of clear coat Very rough substrate

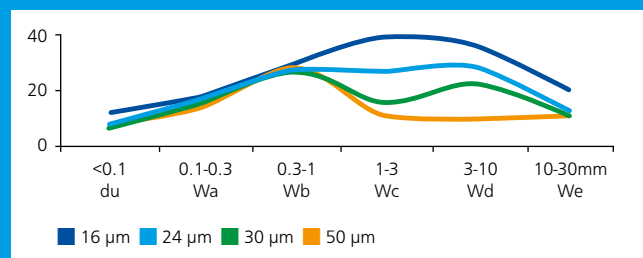

Structure spectrum – a diagnostic tool for trouble shooting:
Influence of clearcoat film thickness



Multi-angle color and effect control with BYK-mac family

Color consistency is the most obvious and thus, most important quality criteria of an automotive finish. Designers are continuously looking for new colors which not only make the product look exciting, but actually underline its styling resulting in a “living” color! More than 50% of today’s automotive colors are special effect finishes. A lightness or even color change can be observed under different viewing angles and a sparkling effect can be created under direct sunlight. Objective control of total color impression is needed which correlates with the visual impression and can be used for daily QC at the paint supplier for paint batch approval, as well as at the part and assembly plants. Establishing color specifications for effect finishes has been a challenging task.

As color perception of effect finishes is changing by viewing angle it is necessary to define different tolerances for each viewing angle. Therefore, new color equations based on visual correlation studies were developed (dE94 with lightness travel, dEDIN 6175-2, dEAudi2000). In order to capture total color impression, the appearance change under different lighting conditions resulting in a more or less sparkling/grainy look, needs to be measured.



Process Stability to Guarantee Uniform Color and Appearance

In order to guarantee uniformity over time and be able to proactively take measurements when color or appearance is starting to drift, process stability needs to be controlled. Therefore, a representative number of measurements have to be taken. Statistical studies have shown that a minimum of 5% of the daily production output needs to be sampled in order to make an objective judgment of process stability. The BYK-Gardner wave-scan and BYK-mac can be used as portable devices or as automated versions which can be mounted on a robot. The wave-scan ROBOTIC as well as the BYK-mac ROBOTIC are robust, light weight and offer fast data collection, which makes them ideal for industrial online applications. By measuring with a robot the same measurement area is always checked, and any operator errors (wrong measurement direction...) which could have an influence on the final reading are eliminated.



Touch the color with our new spectro2guide:

There it is in black and white: The new spectro2guide has arrived. The revolution in color management.



Upfront design. Color touchscreen. Camera preview. Auto calibration. Gloss. Fluorescence. Digital standard...

www.touchthecolor.com

Introduction

Transparency

The appearance of a transparent product is defined by its application. Packaging film used in the food industry should be very clear and transparent, while film for grocery bags should be translucent and diffuse the light. Therefore, different raw materials are selected and processed under certain conditions.

The absorption and scattering behavior of the transparent specimen will determine how much light will pass through and how objects will appear through the transparent product.

Total Transmittance

Total transmittance is the ratio of transmitted light to the incident light. It is influenced by the absorption and reflection properties, example:

Incident light	100 %
– Absorption	-1 %
– Reflection	-5 %
Total Transmittance	= 94 %

The totally transmitted light consists of the directly transmitted and the diffused components. Depending on the angular distribution of the diffused portion, a transparent plastic will appear differently.

Visual perception can clearly differentiate two phenomena:
Wide angle and narrow angle scattering.

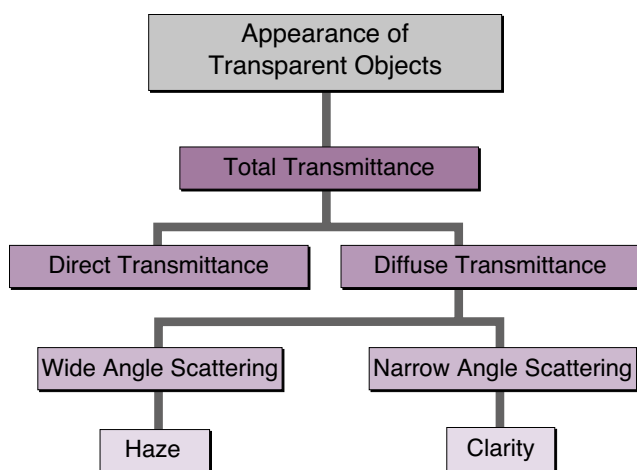

TRANSPARENCY

Haze: Wide Angle Scattering

Light is diffused in all directions causing a loss of contrast. ASTM D 1003 defines haze as that percentage of light which in passing through deviates from the incident beam greater than 2.5 degrees on the average.

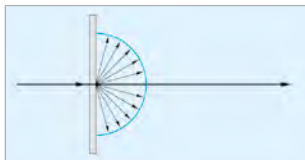

Clarity: Narrow Angle Scattering

Light is diffused in a small cone with high concentration. This effect describes how well very fine details can be seen through the specimen. The see-through quality needs to be determined in an angle range smaller than 2.5 degrees.

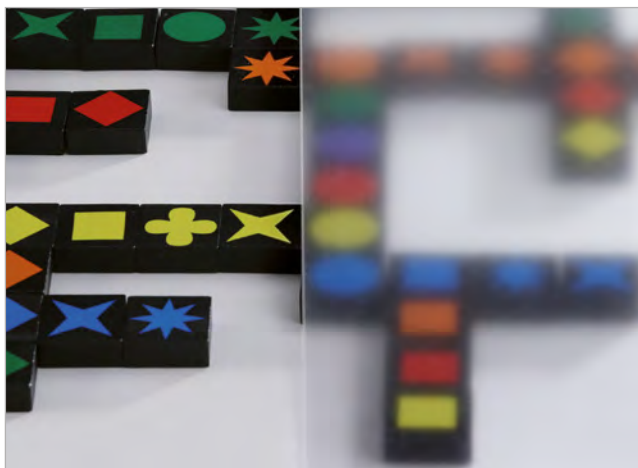

Objective Measurement of Transparency

Measurement and analysis of haze and clarity guarantee a uniform and consistent product quality and help analyze influencing process parameters and material properties, e.g. cooling rate or compatibility of raw materials.

The figure on the right hand side shows the measurement principle of the haze meter: A light beam strikes the specimen and enters an integrating sphere. The sphere's interior surface is coated uniformly with a matte white material to allow diffusion. A detector in the sphere measures total transmittance and transmission haze. A ring sensor mounted at the exit port of the sphere detects narrow angle scattered light (clarity).

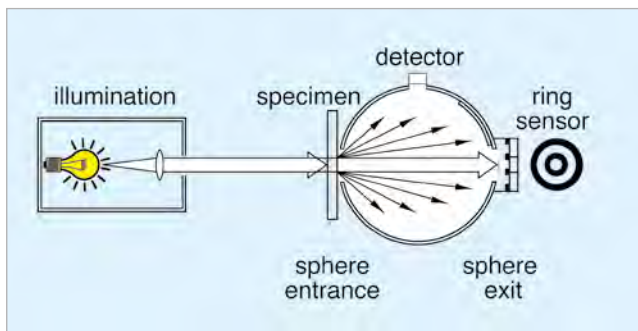

Standard Methods

The measurement of Total Transmittance and Transmission Haze is described in international standards. Two different test methods are specified:

- ISO 13468 Compensation method
- ASTM D1003 Non-compensated method

The compensation method takes the light reflected on the sample surface into account. Differences between the two methods can be approximately 2 % Total Transmittance on clear, glossy samples.

ASTM D 1003

Measurement conditions are different during calibration and actual measurement. During calibration, part of the light escapes through the open entrance port of the hazemeter. While taking a measurement, the entrance port is covered with the sample. Thus, the amount of light in the sphere is increased by the light reflected at the sample surface.

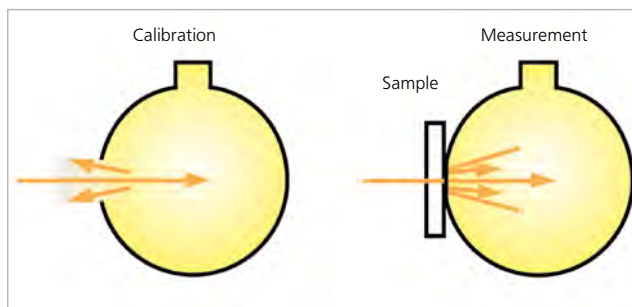

No compensation: Different Sphere Efficiency

ISO 13468

Measurement conditions are kept equal during calibration and measurement due to an additional opening in the sphere. During calibration the sample is placed at the compensation port. For the actual measurement, the sample is changed to the entrance port. Thus, the so-called sphere efficiency is independent of the reflection properties of the sample.

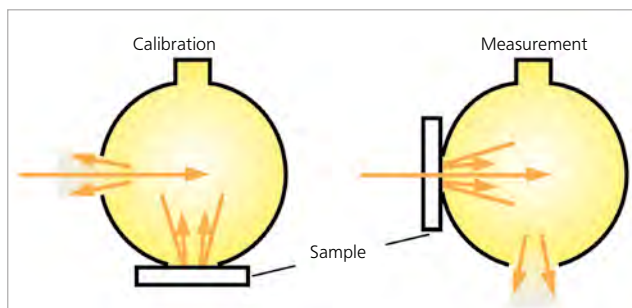

Compensation Port: Same Sphere Efficiency

Two Standard Methods in one Unit

The haze-gard i objectively measures Total Transmission and Haze according to the ASTM and ISO standard methods. The new optical design allows simultaneous measurement without placing the sample to a separate compensation port.



haze-gard i

The objective standard for a clear view

Transparent products can have a milky or fuzzy appearance dependent on their light scattering behavior. The haze-gard i quantifies the visual perception with objective measurement criteria:

- Total transmittance
- Transmission haze
- Clarity

haze-gard i controls complete transparency by taking only one reading.



Global communication

Haze and transmittance control according to international standard methods with one unit:

- ASTM D1003 - illuminants C and A
Non-compensated method
- ISO 13468 - illuminant D65
Compensated method

haze-gard i displays all results simultaneously - well prepared for any customer specification.



Reliable and Precise

With state-of-the-art optics and LED technology the haze-gard i delivers an unprecedented performance:

- Reference beam, self-diagnosis and enclosed optics
- LED light source assures long-term stable results for many years: 10 year warranty on the lamp life!
- Automatic, long-term calibration - operator friendly and safe

Superior repeatability and inter-instrument agreement are guaranteed.

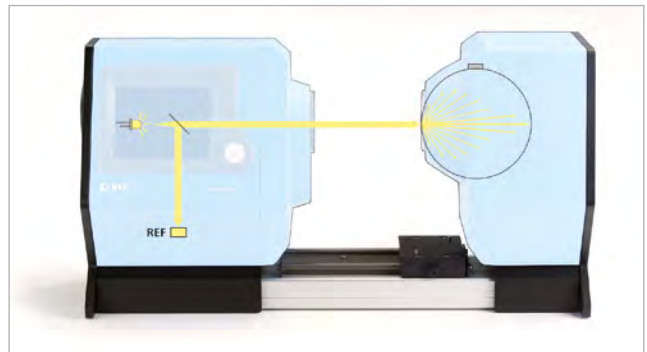

Smart and Fast

The new touch display is designed to be intuitive and easy to use for any task:

- Large touch display in color
- Symbols to select a menu function
- Dedicated measurement button
- Foot switch allows hands-free operation



Open and Flexible

The open measurement compartment let's you work freely to analyze any sample size:

- Open design for small and large specimens
- Fast change and positioning of samples
- No influence of ambient light
- Versatile sample holder for films and sheets
- Sample holders for taber abrasion test and cuvettes for liquids optional
- Customized sample holders can be easily attached

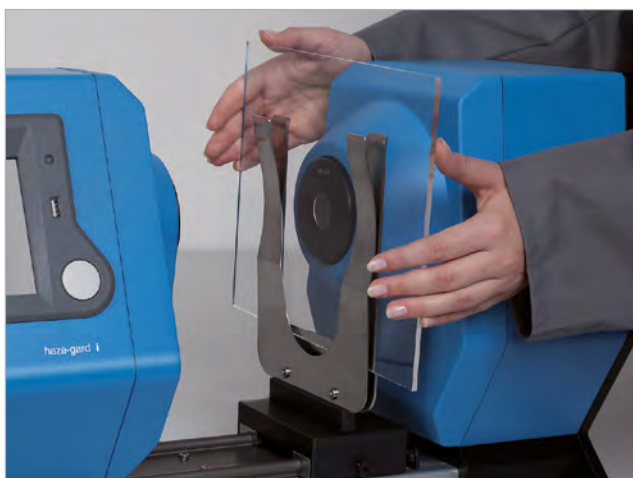

Horizontal or vertical set-up

Sample handling in any position is convenient and allows you highest flexibility.



Onboard analysis

Measurement data can be analyzed and saved in projects directly in the haze-gard i for efficient work management:

- Large instrument memory (5000 readings)
- Complete statistics with averaging, min / max, standard deviation
- Limit input for different product specifications with colorful Pass/Fail analysis



Professional connection

Data transfer can be performed in all sorts of ways to support you in routine lab work:

- Direct data transfer via USB-port to PC
- Direct LAN connection to your network for further analysis in Laboratory Information Management Systems (LIMS)
- Save data on a USB-stick

smart-lab haze – data analysis software

Whatever the task, smart-lab haze will do it for you. From simple data tables of single test series to trend reports over time - anything is possible.

- Define your product specifications in standard management by setting up product groups with Pass/Fail limits
- Measure your products online and get instant QC reports displayed: Data table with statistic and line graph including Pass/Fail coloring
- Manage your lab work in projects to show production process stability using trend reports
- Transfer product specs and projects to haze-gard i and vice versa for daily work management

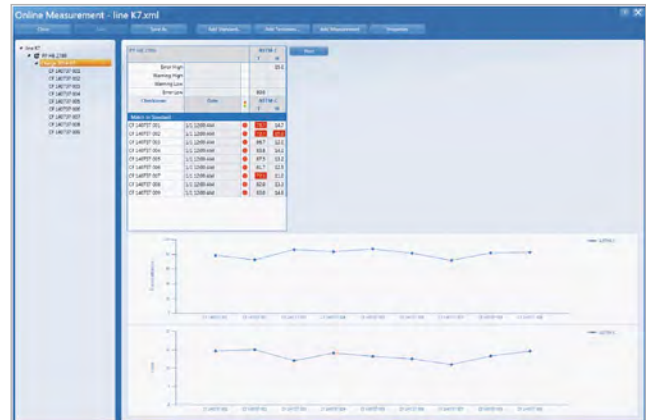



Standards

ASTM	D 1003, D 1044
ISO	13468, 14782

Technical Specifications

Illuminants	CIE-C, CIE-A (ASTM D1003) CIE-D65 (ISO 13468, ISO 14782)
Spectral Response	CIE luminosity function y
Geometry	0° / diffuse
Measurement Area	ø 18 mm (0.7 in)
Sample Port	ø 25.4 mm (1.0 in)
Measurement Range	0 - 100 %
Repeatability	± 0.1 units (standard deviation)
Reproducibility	± 0.4 units (standard deviation)
Memory	5000 readings
Interface	LAN, USB 2.0, additional front USB-port for memory stick
Power Supply	115 V /230 V self adapting
Operating Temperature	+10 to 40 °C (+50 to 104 °F)
Storage Temperature	0 to 50 °C (+32 to 122 °F)
Dimensions	62 x 33 x 22 cm (24 x 13 x 9 in)
Weight	18 kg (40 lbs)



Ordering Information

Cat. No.	Description
4775	haze-gard i

Comes complete with:

Hazemeter
Guide carriage for sample holders
Clarity calibration standard
Traceable certificate
Foot switch and power cable
USB-cable and LAN-cable
Software for download:
smart-lab haze with 2 Licenses
Operating manual
Training

System requirements:

Operating system: Windows 7 SP1, 8.1 or 10
Microsoft® .NET Framework 4.5.2
Hardware: Core 2 Duo, 2.5 GHz, i7 recommended, or equivalent
Memory: 4 GB RAM, 8 GB recommended
Hard-disk capacity: 2 GB during installation
Monitor resolution: 1280 x 1024 pixel or higher
Interface: free USB-port or network access

Training

BYK-Gardner offers you more than just an instrument. We train you in the operation of the haze-gard i and data analysis. A half-day training course for haze-gard i operation and smart-lab haze software is included.

Versatile sample holders for specific needs



Sample holder for films and sheets. The precision guide carriage allows easy replacement of different holders.



Special holder for very thin films.



Ordering Information

Cat. No.	Description
4788	Sample holder, for 4775
4784	Thin Film Holder, for 4775
4785	Taber Abrasion Holder, for 4775
4786	Cuvette Table, for 4775
6180	Cuvette for Liquids, 2.5 mm
6182	Cuvette for Liquids, 5 mm
6183	Cuvette for Liquids, 10 mm
6189	Cuvette for Liquids, 20 mm
4865	BYKWARE smart-lab haze

Accessories

For films and sheets
Special holder for very thin films
For evaluation of abrasion resistance with the hazemeter
For measurement of liquids
Path length 2.5 mm, edge length 50 mm
Path length 5.0 mm, edge length 50 mm
Path length 10 mm, edge length 50 mm
Path length 20 mm, edge length 50 mm
Software for professional analysis and documentation



The measurement of haze is used to determine abrasion resistance of transparent materials. The haze-gard i Abrasion Holder facilitates positioning of the abraded area in the measurement beam.



Liquids are best measured using cuvettes and the cuvette table.



Ordering Information

Cat. No.	Description
4776	Clarity Calibration Standard, for 4775
4777	Clarity Reference Standard, for 4775
4790	Haze Standard 1, for 4775
4791	Haze Standard 5, for 4775
4792	Haze Standard 10, for 4775
4793	Haze Standard 20, for 4775
4794	Haze Standard 30, for 4775
4795	Haze Standard Set, for 4775
4778	Transmittance Standard 10, for 4775
4779	Transmittance Standard 30, for 4775
4780	Transmittance Standard 50, for 4775
4781	Transmittance Standard 70, for 4775
4782	Transmittance Standard 90, for 4775
4783	Transmittance Standard Set, for 4775

Accessories

Replacement Standard for clarity, certificate included
Test standard for checking purposes, certificate included
Approx. 1% haze, for checking purposes, certificate included
Approx. 5% haze, for checking purposes, certificate included
Approx. 10% haze, for checking purposes, certificate included
Approx. 20% haze, for checking purposes, certificate included
Approx. 30% haze, for checking purposes, certificate included
Set of 5 pieces in hard box, certificate included
Approx. 10% total transmittance, for checking purposes, certificate included
Approx. 30% total transmittance, for checking purposes, certificate included
Approx. 50% total transmittance, for checking purposes, certificate included
Approx. 70% total transmittance, for checking purposes, certificate included
Approx. 90% total transmittance, for checking purposes, certificate included
Set of 4 pieces in hard box (T30, T50, T70, T90), certificate included

Quality Requirements of Transparent Sheets

Light weight and high design flexibility make transparent plastic sheets attractive for use as “organic glass” in many different applications e.g. noise barriers, green houses, sport arenas, sky domes, solar panels or bus stop shelters. In addition, rigidity and impact resistance of acrylic (PMMA) and polycarbonate (PC) sheets were optimized expanding its usage for safety and architectural glazing as well as for automotive, aircraft, yacht or caravan applications. Depending on the application, the transparency requirements will be very different and need to be objectively controlled – often within very tight specification.



Influence of material properties

Sheets for outdoor use need to withstand extreme weather conditions and require high rigidity over a long lifetime. As an example, PMMA typically shows increasing haze with higher temperatures and therefore, limits its use in automotive glazing where low haze is a crucial safety requirement. Material development has further allowed this behavior to improve and resulted in an optimized PMMA material with low temperature dependency ideal for automotive applications like rear windows. Automotive glazing is tested and approved in accordance to international regulations like e.g. ECE R43 or ANSI Z 26.1 in regards to mechanical, chemical and fire resistance, and last but not least transmission properties.

Temperature Influence on different PMMA types

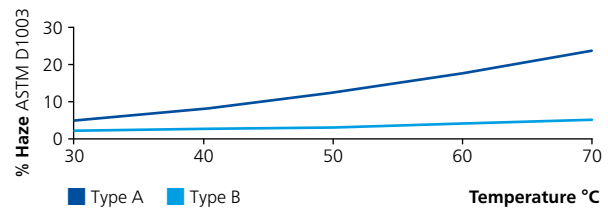

Abrasion resistance

A critical behavior of plastic materials has been their limited abrasion resistance, which in many applications requires additional efforts, such as modifications of the polymer or use of appropriate coatings. A widely used method for abrasion testing is the so-called Taber test according to ASTM D1044, where the sample is turned under abrasive wheels at defined conditions. After a certain number of cycles transmission haze is measured. To guarantee repeatable and representative readings, a special holder is available, which allows placement of the scrub mark exactly in the optical path of the haze-gard i.

Taber Abrasion

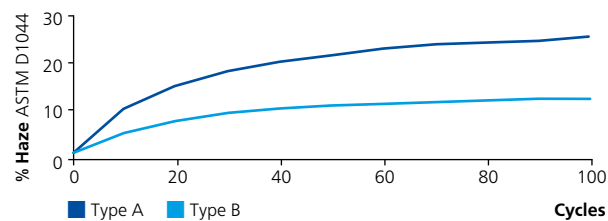

The graph above shows the abrasion results of different uncoated PMMA types used for public and sport glazing.

Appearance

Color

Physical Properties

Technical Service

Index

COLOR



COLOR

Solid Color

Introduction	79
Portable Color	84
New! spectro2guide	84
New! Software smart-chart	86
Accessoires for Cosmetics	92

In-store Color Matching

Introduction	96
auto-match III Sensor	97
Software auto-match	98

Metallic Color

Introduction	99
BYK-mac i: multi-angle color and effect	105
BYK-mac i for small parts	107
Accessoires for Cosmetics	111
BYK-mac i COLOR	115
BYK-mac i ROBOTIC	118
Software smart-process	121
Software smart-lab	124

Liquid Color

Introduction	127
Visual Color Comparators	128
Instrumental Measurement	131
LCM IV	131
LCS IV	132

Light Booths

Introduction	137
Metallic Color and Sparkle	139
New! Solid Color	140

**Touch the color –
Raise your expectations**



BYK-mac i WiFi Adapter



byko-spectra pro



Introduction

Color Perception

Ten million! That is the number of different colors that we can distinguish. No wonder we cannot remember colors well enough to identify a particular shade. However, the quality criterion “color” is becoming more and more important in every industry. Uniform color influences customers’ likes and dislikes. This is of particular importance when the individual components of the final product are manufactured at different company sites, or even more complicated when several suppliers are involved. Nevertheless, in the end the color must be right.

Visual color perception is influenced by different color sensitivities from person to person (mood, age, etc.), varying environments such as lightness and color, as well as the deficiency to communicate and document color and color differences.

These shortcomings can only be solved by using color instrumentation with internationally specified color systems. This guarantees objective description of colored objects. Color perception is dependent on the interaction of three elements:

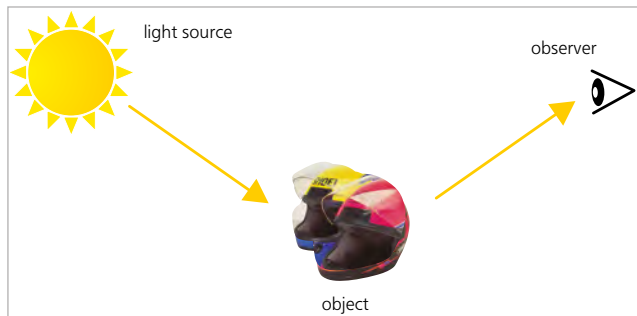

SOLID COLOR



Light Source

Color changes with the light source. Therefore, standard illuminants have to be agreed upon and used. The prerequisite of a light source to be usable for color evaluation is to continuously emit energy throughout the visible spectrum (400 to 700 nm).

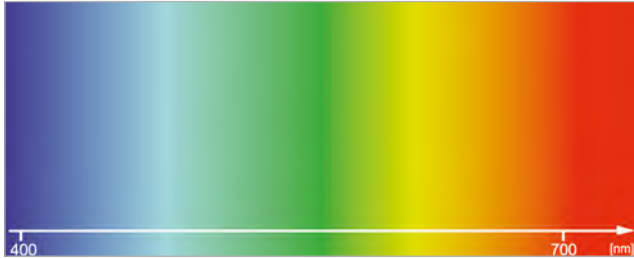

White daylight dispersed into the spectral colors (rainbow)

The CIE (Commission Internationale de l'Éclairage) standardized light sources by the amount of emitted energy at each wavelength (= relative spectral power distribution).

In practice, important illuminants are:

- Daylight D65, C
- Incandescent light A
- Fluorescent light F2, F11

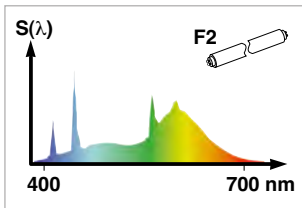
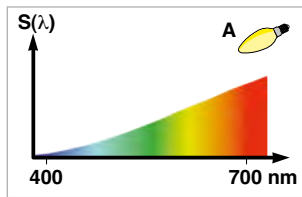
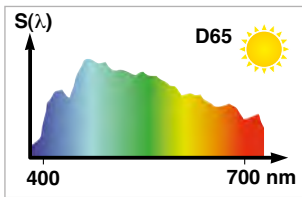

Observer

Without an observer there would be no color. Reflected light from a colored object enters the human eye through the lens and strikes the retina. The retina is populated with three different types of light-sensitive receptors: one which reacts to red light, another to green light, and a third to blue light.

Together they stimulate the brain to produce the impression of color. To determine the sensitivity of the receptors, systematic visual tests were done by the CIE in 1931 and 1964.

Based on the results, the 2° and 10° observer were standardized, representing a small and large field of view, respectively.

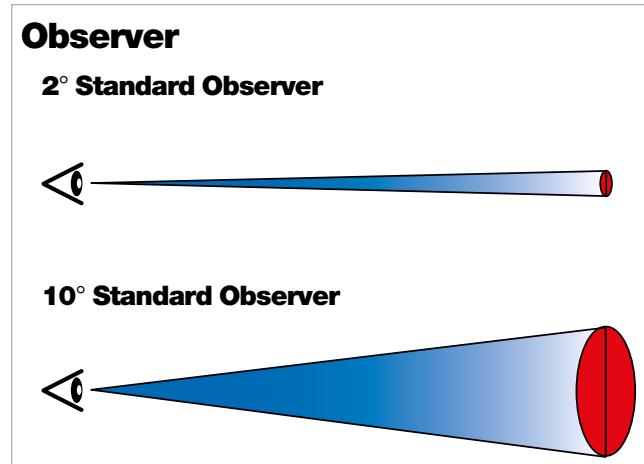

When viewing a sample, the eye integrates over a large area, which correlates best to the 10° observer.

Object

Light source and observer are defined by the CIE and their spectral functions are stored within color instruments. Optical properties of an object are the only variables that need to be measured. Modern color instruments measure the amount of light that is reflected by a colored sample. This is done at each wavelength and is called the spectral data.

For example, a black object reflects no light across the complete spectrum (0% reflection), whereas an ideal white specimen reflects nearly all light (100% reflection). All other colors reflect light only in selected parts of the spectrum. Therefore, they have specific curve shapes or fingerprints, which are their spectral curves.

In the following graphs, typical spectral curves for a red, blue and green sample are shown.

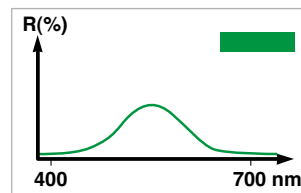
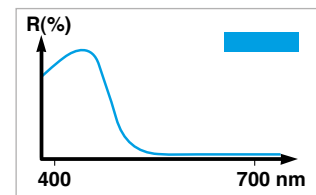
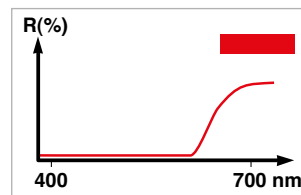

Color Systems

Color systems combine data from three elements:

- light source
- observer
- object

They are the tools to communicate and document color and color differences.

The system which is recommended by the CIE and widely used today, is the CIELab system.

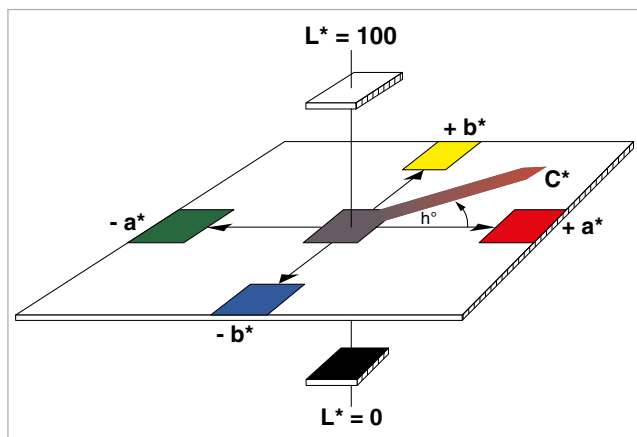

It consists of two axes a^* and b^* which are at right angles and represent the hue dimension or color. The third axis is the lightness L^* . It is perpendicular to the a^*b^* plane.

Within this system, any color can be specified with the coordinates L^* , a^* , b^* . Alternatively L^* , C^* , h° are commonly used. C^* (= Chroma) represents the intensity or saturation of the color, whereas the angle h° is another term to express the actual hue.

To keep a color on target a standard needs to be established and the production run is compared to that standard; a typical customer / supplier situation. Therefore, color communication is done in terms of differences rather than absolute values.

The total change of color, ΔE^* , is commonly used to represent a color difference.

$$\Delta E^* = \sqrt{(\Delta L^*)^2 + (\Delta a^*)^2 + (\Delta b^*)^2}$$

The same ΔE^* value can be obtained for two sample sets, and yet look completely different:

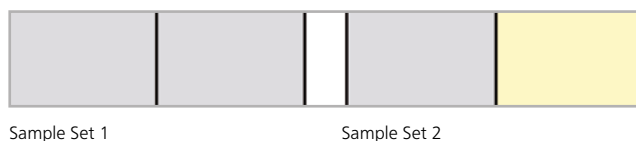

	Sample Set 1	Sample Set 2
ΔL^*	0.57	0.0
Δa^*	0.57	0.0
Δb^*	0.57	1.0
ΔE^*	1.0	1.0

To determine the actual change in color, the individual colorimetric components ΔL^* , Δa^* , Δb^* or ΔL^* , ΔC^* , ΔH^* need to be used.

The calculation and interpretation of the differences are done as follows:

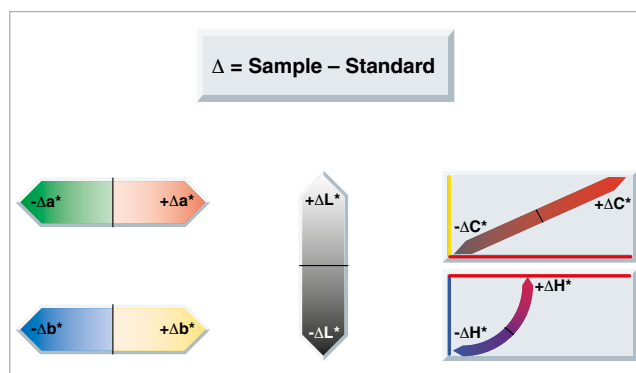

The color differences that can be accepted must be agreed upon between customer and supplier. These tolerances are dependent both on demands and technical capabilities.

Color Instrumentation

In industry, there are two classes of instruments used to measure color: 45/0 and sphere geometry.

Control color as you see it

The 45/0 geometry uses 45° circumferential illumination and 0° viewing perpendicular to the sample plane.

The circumferential illumination is essential to achieve repeatable measurement results on directional and structured surfaces.

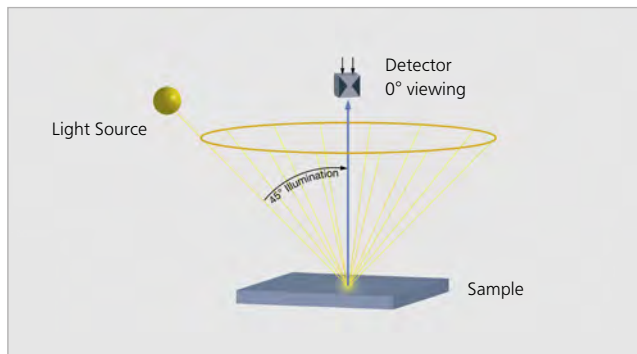

The 45/0 geometry simulates the normal condition used for color evaluation. For example, when we read a glossy magazine we position it to avoid the gloss from coming into our eye. A high gloss sample with the same pigmentation is visually judged darker by the eye when compared to a matte or structured sample. This is exactly what a 45/0 instrument measures:

Differences in gloss / texture Color differences

On the automotive interior plaque, you will get a difference between the two structured sides: $\Delta E^* = 3$

Applications where it is necessary to have the agreement with the visual assessment are:

- Batch to batch comparison in production
- Assembly of multi-component products using different materials



Example: Automotive interior plaque - one material with different structures.

Control the hue of your color

A sphere geometry illuminates the sample diffusely by means of a white coated integrating sphere. Baffles prevent the light from directly illuminating the sample surface. Measurement is done using an 8° viewing angle.

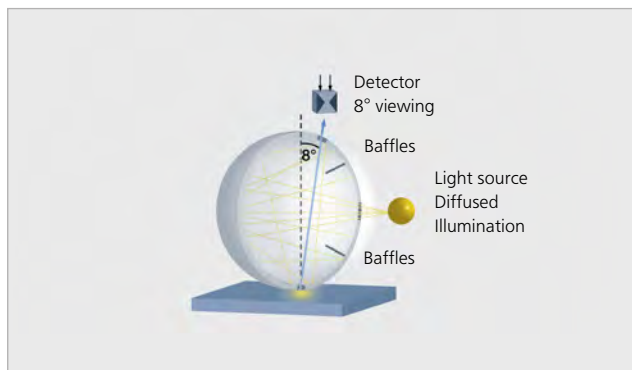

A sphere instrument may be operated under two different measurement conditions:

specular included (spin) or specular excluded (spex)

In the "spin" mode, the total reflected light is measured:

Diffuse reflection (color) + direct reflection (gloss)

Color is measured independent of the sample's gloss or surface texture.

Differences in gloss / texture → Color differences

On the automotive interior plaque, you will get no difference between the two structured sides: $\Delta E^* = 0$

Applications for measurements taken in "spin" mode:

- Color strength depending on dispersion time
- Weathering and temperature influence on color
- Color matching

In the "spex" mode, a gloss trap is used to capture the directly reflected light (gloss). This configuration simulates the 45/0 geometry.

Summary

Only measurements taken under the same conditions can be compared. Therefore, it is necessary to note the following information in a color measurement report:

- Color instrument (geometry)
- Illuminant / observer
- Color system
- Sample preparation

BYK-Gardner offers a complete line of benchtop and portable spectrophotometers for color measurement.

Fluorescence

Fluorescence is the spontaneous emission of light by a substance that has absorbed light. Part of the emitted light is released as heat. Therefore, the fluorescent light is typically of lower energy and thus, has a longer wavelength than the exciting light. This phenomenon is called "Stokes Shift" and well known for optical brighteners that absorb light in the UV-range and emit the fluorescent light in the blue wavelength range. However, it can also occur in the visible range, e.g. light excited in the blue wavelength range can be shifted to the green, yellow or red wave-length range.

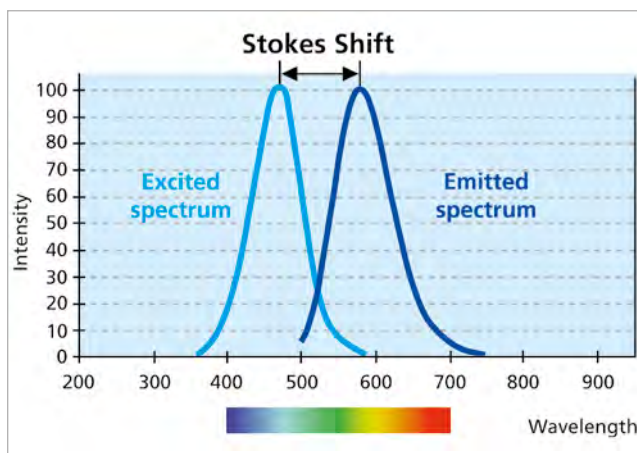

Measurement of Fluorescence

Traditional color measuring instruments work with both a polychromatic illumination (e.g. tungsten lamp, xenon flash etc.) and a monochromatic detection (grating, filter array etc.).

As commercially available spectrophotometers use different light sources, the measurement results will be different for specimens containing fluorescent ingredients. Different light sources show different spectral power distributions and therefore, the amount of illuminated light exciting the fluorescent components will be different. Depending on the specific excitation range, a particular fluorescent component will absorb the excitation light and emit the fluorescent light in the longer wavelength range. Consequently, the amount of emitted fluorescent light will differ dependent on the amount of the excitation light. Thus, the measurement results of spectrophotometers with different light sources cannot be compared.

In practice, fluorimeters are used to evaluate fluorescent samples. These setups use monochrome illumination and thus, can detect the amount of fluorescent light independently of the specific light sources. The monochrome illuminations need to be calibrated to the same level. For colorimetric calculations under different illuminants this calibration must be done in respect to each illuminant type.

The spectro2guide is a revolution in color measurement. It unites a fluorimeter and a portable spectrophotometer in one instrument. For illumination a full spectrum, white power LED and 12 monochromatic LEDs are used. The detector is a miniaturized spectrometer detecting light in the range of 360 – 760 nm.



By comparing the characteristic spectral power distributions of the white power LED and the 12 monochromatic LEDs, it is able to detect, allocate and quantify the fluorescent light. In addition, the spectro2guide is able to calculate how the specimen will look like under different illuminants ("Fluorescence metamerism") and it can calculate how the color will change when the fluorescence has degraded (ΔE_{zero}).

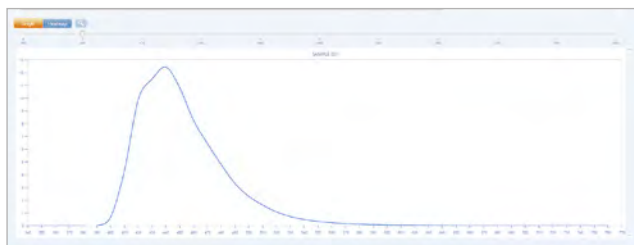

It is the first portable spectrophotometer on the market, which can be used for a reliable Quality Control of fluorescent specimens.

spectro2guide

Three in One Color. Gloss. Fluorescence.

The spectro2guide spectrophotometer represents the next step in the evolution of color measurement. Just like its predecessor, color and 60° gloss are measured simultaneously. Completely new is the quantification of fluorescence by measuring like a fluorimeter with monochrome illuminations. Colorful graphs show the fluorescent results on the display and new fluorescent indices are calculated for easy analysis.

Perfectly formed Design Approachable. Balanced. Upfront.

The new instrument follows a very simple rule, which is not so easy to put into practice: "Form follows function". Due to its balanced and upfront design, the display is always in the right position and easy-to-read, whether on horizontal, vertical, large or small surface areas – even true for overhead work. You no longer need to bend out of shape for measurement and data reading. The display flips around for you.

Brilliant Color Display Swipe. Touch. Measure.

As for mobile phones, there is a trend towards ever-larger displays. The new spectro2guide is completely in line with this trend offering a 3.5" color touchscreen – the largest on the market. An icon-based menu, colorful data tables and graphics ensure an intuitive smart phone like operation. As you are used to, you can touch or swipe with your fingers – it even works when wearing gloves. Alternatively, you also can use a stylus, which is enclosed in the housing – always handy.



Preview with Camera Strike. Score. Save.

An integrated camera shows a live preview of the measurement spot. To ensure precise positioning and to prevent false readings on imperfections or scratches, the measurement spot is magnified by a factor of 4.5:1. It is so easy – just press the measurement button halfway and the live preview is active.

spectro2guide

Tricky Fluorescence Excited. Emitted. Shifted.

To quantify fluorescence two new indices, ΔFI and $\Delta Ezero$ are calculated. The index ΔFI (delta Fluorescence) indicates whether and how much fluorescent light is emitted by the standard and the sample – important for everybody who wants to avoid any fluorescent ingredients in the product material. The index $\Delta Ezero$ calculates how the color will change when the fluorescence has degraded.

In addition, the spectro2guide calculates how fluorescent specimens will look like under different illuminants (“Fluorescence Metamerism”).



Smart Docking Station Park. Charge. Control.

As first spectrophotometer on the market, the spectro2guide offers auto diagnosis and an automatic calibration function. The spectro2guide with the docking station make a perfect couple – the white calibration standard is always protected and a reliable calibration is guaranteed. The docking station automatically charges the instrument. You only have to park the spectro2guide, the rest happens automatically. The smart docking station offers you a 2-in-1 advantage: Be ready at any time, be safe at any time – do not lose time with charging and daily calibration by hand.

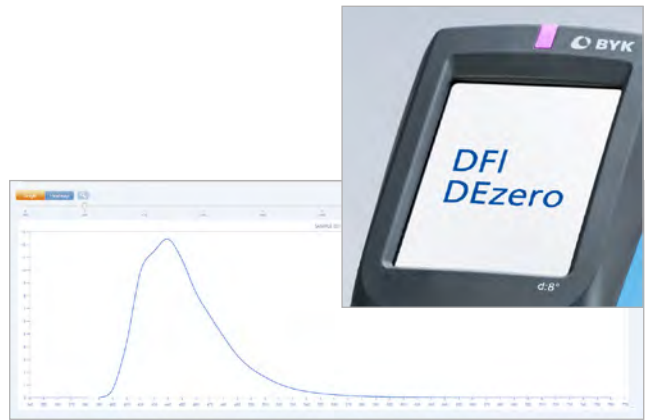

BYK LED Technology High-tech. Smart. Experienced.

Like the predecessor, the spectro2guide uses innovative, high-tech LED technology as light sources. Smart testing combined with our long-standing experience guarantees an outstanding performance of the LEDs. Short-term, long-term and temperature stability as well as a homogeneous illumination spot are unsurpassed in the industry. As a result, a superior accuracy and excellent inter-instrument agreement allow use of digital standards. One binding reference eliminates sources of error and physical standards no longer need to be exchanged.



Flexible Data Transfer Wireless. Boundless. Flawless.

Adaptable to your situation and specific location, the spectro2guide offers three possibilities to transfer data: Via docking station or directly connected with USB cable or wireless with Wi-Fi function. Your data transfer is now guaranteed flawless and not tied down by a cable length.

smart-lab Color

Online Control in the laboratory

Color control in the laboratory requires on one hand open and flexible data analysis and on the other hand efficient data handling of large data sets. Measure your products offline or online and transfer the results to smart-lab Color and you will get professional QC-reports, immediately.

Online Measurement - and instant data analysis

Just connect the spectro2guide with the PC, measure the master panel, apply the respective tolerances and compare the actual samples against the standard. The data are displayed in a data table with Pass/Fail information and shown in various color graphs. Alternatively, you can recall a standard and samples from a database and quickly add new readings. Popular functions such as saving, deleting or copying can be executed with right mouse click.

Standard Management - extensive flexibility of tolerance methods

smart-lab Color includes powerful standard management which allows defining Pass / Fail tolerances based on any color control parameter.

Digital Standard - guarantees a seamless workflow

Thanks to the outstanding inter-instrument agreement of spectro2guide smart-lab enables you to use "digital standards" on a global basis with your entire supply chain. Export and import your color standards in xml file format and send them by email to your supply chain. Thus, color control data are reliable and communication among all parties is seamless and efficient.

Ultimate flexibility - Swap standard/sample and vice versa

Interested in how the previous batch compares to the current batch? Just drag & drop the data or even select a sample as the standard. Additionally, it is also possible to calculate the mean value based on a population of samples and use it as a new standard. This is of high interest when selecting a master standard out of a population of standard panels

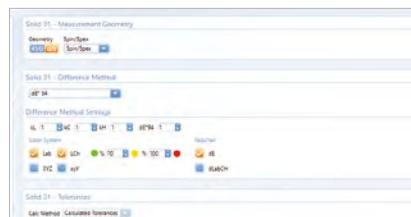
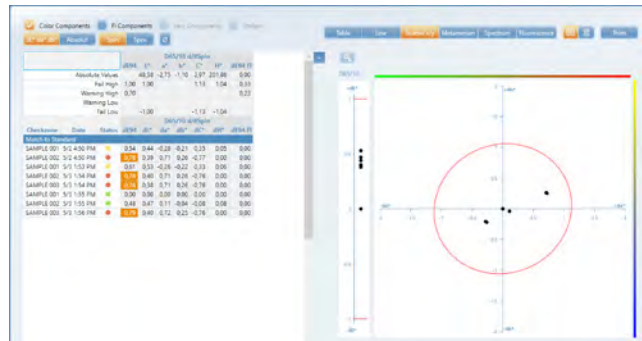

The screenshot shows the 'spectro2guide sphere' software interface. It displays a table for a digital standard. The table has columns for 'Angle', 'L*', 'a*', 'b*', 'c*', 'h*', 'dF1', and 'Gloss'. The data is as follows:

Angle	L*	a*	b*	c*	h*	dF1	Gloss
d/SPin D65/10	48.96	-2.05	-0.83	2.21	202.15	0.00	
d/SPex D65/10	45.76	-2.61	-1.36	2.94	207.55	0.00	
60°							1.18

Color Data analysis - variety of measurement reports

Data analysis was never easier. Results are simultaneously displayed in a data table and a graph highlighting the samples being out of specification. Easily toggle between measurement conditions like different illuminants or SPIN/SPEX. Multiple settings can even be combined in one project allowing the user to have multiple pass/fail criteria at one glance. Graphically display color results in the way that works best for your application: scatter plot, line graph, metamerism graph and spectral curves can be selected by just a mouse click.

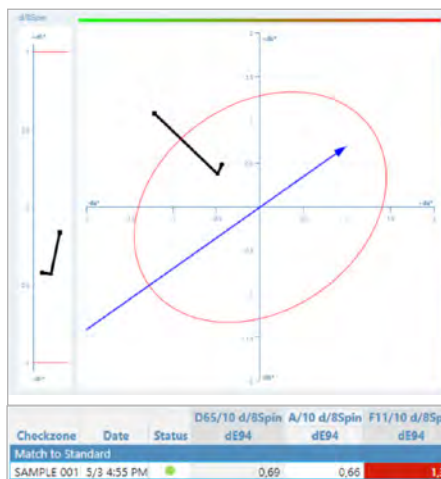

Fluorescence evaluation – new reports for new requirements

For each monochrome LED the total spectral remission curve of the sample is shown consisting of the spectral remission at excitation range plus the shifted fluorescent light. The results of the 12 LEDs can be toggled through by means of a slider.

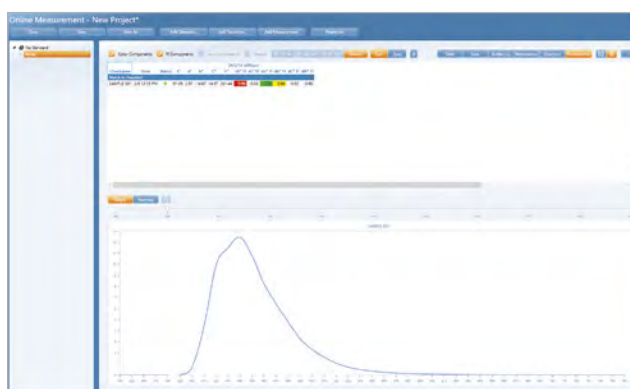

Database management - easy and secure

The data are saved in a SQL database, which allows handling of large data sets over a long time period. This reliable database type also ensures full network and server compatibility. Retrieve data for further analysis based on your specific filter criteria, such as a specific color or a certain time range. Additionally, current standards and samples can be organized in projects. Projects are saved as xml-files and can be easily shared with other smart-lab users. With smart-lab, you can start faster and finish sooner without getting lost in Details.



Ordering Information

Cat. No.	Description
7083	Software smart-lab Color, spectro2guide

Comes complete with:

Software with 2 licenses for download

System Requirements:

Operating system: Windows 7 SP1, 8.1 or 10
 Microsoft® .NET Framework 4.5.2
 Hardware: Core 2 Duo, 2.2 GHz; i7, 2.5 GHz recommended, or equivalent
 Memory: 4 GB RAM, 8 GB recommended
 Hard-disk capacity: 2 GB during installation
 Monitor resolution: 1280 x 1024 pixel or higher
 Interface: free USB-port

Technical Specifications

Software for professional analysis and documentation in the laboratory

Instruments	spectro2guide d/8, spectro2guide 45/0
Color Differences	ΔE^* , ΔE_{CMC} , ΔE_{94} , ΔE_{2000} , $\Delta E_{DIN6175-2}$, custom specific scales
Illuminants	A; C; D50; D55; D65; D75; F2; F6; F7; F8; F10; F11; UL30
Observer	2°, 10°
Indices	YIE313; YID1925; WIE313; CIE; Berger; Color Strength; Opacity; Metamerism; Grayscale; Jetness; ΔF ; ΔE_{zero}
Graphs	Scatter plot, trend graph, spectral curve, metamerism graph, fluorescence slider
Database format	SQL Server Compact
Export	Project files (.xml format)
Languages	Chinese, English, French, German, Italian, Japanese, Spanish

smart-process Color

Color control in the production

Routine process control requires systematic planning and efficient data handling of large data sets. With smart-process, all critical color parameters are saved and analyzed with one software package. An ideal QC software for production process control. With smart-process, you will know where you are, where you are going, and how to get there.

Standard Management - manage unlimited colors

smart-process includes powerful standard management for defining all essential color control parameters with Pass / Fail tolerances.

Digital Standard - guarantees a seamless workflow

Thanks to the outstanding inter-instrument agreement of spectro2guide smart-process enables you to use "digital standards" on a global basis with your entire supply chain. Export and import your color standards in xml file format and send them by email to your supply chain. Thus, color control data are reliable and communication among all parties is seamless and efficient.

Organizer Set-up - standard measurement procedure

smart-process offers set-up of Organizers for clear sample identification and a menu guided operation on the instrument. Product schematics (e.g. white goods) help to define specific sampling procedures. The entered parameters can be used for filtering the measured data saved in the database. Typical identifiers are model, color or product ID – smart-process is open for your specific needs.

Data Analysis - green light for shipping

Data analysis was never easier. The data are saved in a SQL database, which allows handling of large data sets over a long time. See all your test series at once based on your specific criteria. Select filter criteria, such as a certain time range, a specific color or all "green", "yellow", "red" test series for further analysis.

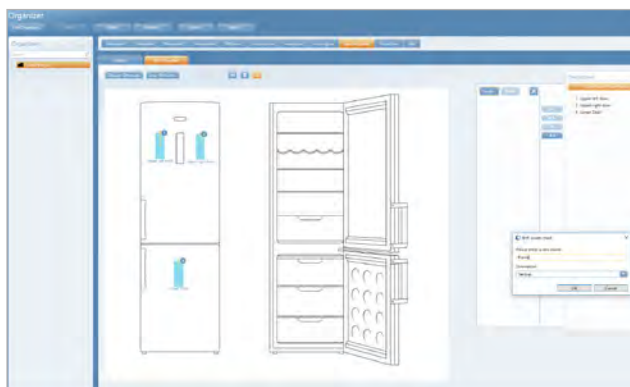
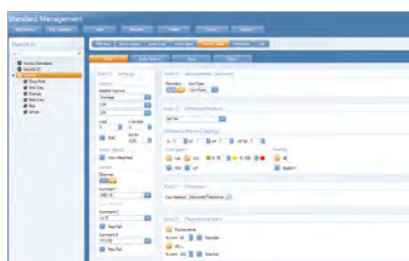
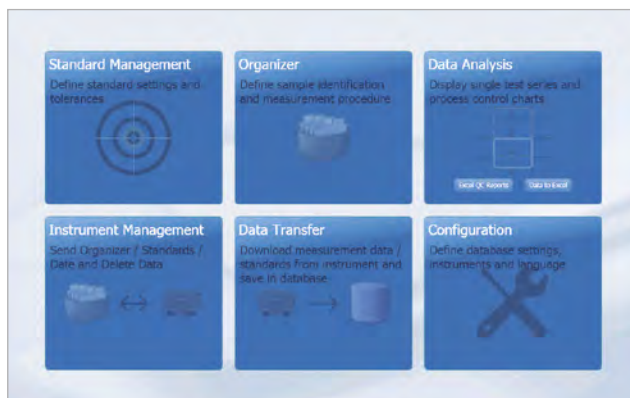

Data analysis - Detailed report of one test series

View and open the measurement data of a single test series with a click. The product schematic quickly shows you where the "problem areas" are. The data are also displayed in an easy-to-read data table highlighting the measurements out of specifications.

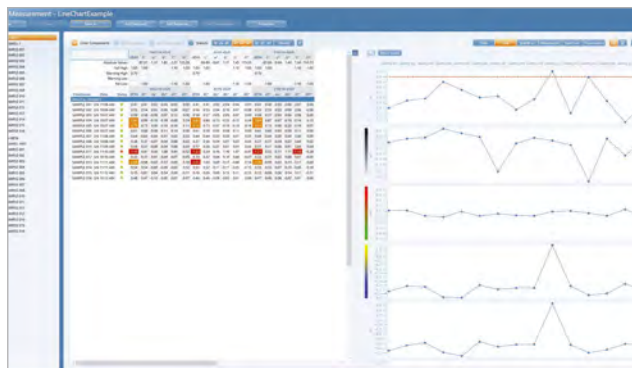

Monitor your process - and document stability

Innovative data analysis reports feature scorecards with drill-in functionality as well as trend reports for all measured parameters. They are so easy to set up that statistical analysis actually becomes a fun project. Valuable time for data crunching will be saved and lengthy discussions analyzing the data will no longer be necessary.



smart-chart Color - Variety of Graphs

- Scatter graph to show at one glance whether all parts are within specification
- Trend graph to monitor process changes over time
- Metamerism graph for three illuminants
- Fluorescence Slider to analyze fluorescence in detail



Ordering Information

Cat. No.	Description
7084	Software smart-process Color, spectro2guide

Comes complete with:

Software with 2 licenses for download

Note:

smart-process licence fee for more than two installations is quantity dependent. Please contact your local BYK-Gardner representative.

System Requirements:

Operating system: Windows 7 SP1, 8.1 or 10
 Microsoft® .NET Framework 4.5.2
 Hardware: Core 2 Duo, 2.2 GHz; i7, 2.5 GHz recommended, or equivalent
 Memory: 4 GB RAM, 8 GB recommended
 Hard-disk capacity: 2 GB during installation
 Monitor resolution: 1280 x 1024 pixel or higher
 Interface: free USB-port

Technical Specifications

Process QC Software for analysis of multi-component products

Instruments	spectro2guide
Export/Import	Color Standard (.xml format) Organizer (.xml format)
Database format	SQL Server Compact
Languages	Chinese, English, French, German, Italian, Japanese, Spanish



In compliance with:

Standards

	Color	Gloss
ASTM	D 2244, E 308, E 1164	D 523, D 2457
DIN	5033, 5036, 6174	67530
DIN EN ISO	11664	
ISO		2813, 7668



Ordering Information

Cat. No.	Description
7070	spectro2guide, d/8
7075	spectro2guide, 45/0

Comes complete with:

spectro2guide, spectrophotometer
 Docking station with built-in calibration standard
 Additional calibration standard
 Certificate for both calibration standards
 Software: smart-chart with 2 licenses
 USB cables and WiFi function for data transfer
 Protection cap and hand strap
 Operating manual
 Carrying case
 Installation training included

Note: After installation both software packages, smart-lab Color and smart-process Color, can be used for 30 days free trial. Thereafter, the user needs to decide and register for one software package.

System Requirements:

Operating system: Windows® 7 SP1, 8.1 or 10
 Microsoft® .NET Framework 4 SP1
 Hardware: Core 2 Duo, 2.2 GHz, i7 recommended, or equivalent
 Memory: 4 GB RAM, 8 GB recommended
 Free hard-disk capacity: 2 GB during installation
 Monitor resolution: 1280 x 1024 pixel or higher
 Interface: free USB-port

Note: smart-chart licence fee for more than two installations is quantity dependent. Please contact your local BYK-Gardner representative.

Technical Specifications

Color Geometry	Gloss Geometry	Color Aperture	Gloss Aperture
d:8° (spin/spex)	60°	12 / 8 mm	5 x 10 mm
45°c:0°	60°	12 / 8 mm	5 x 10 mm

Color

Spectral Range Color 400 - 700 nm, 10 nm resolution

Spectral Range Fluorescence 340 - 760 nm, 10 nm resolution

Repeatability 0.01 ΔE^* (10 consecutive measurements on white)

Reproducibility 0.1 ΔE^* (average on 12 BCRA II tiles)

Color Systems CIE Lab/Ch; Lab(h); XYZ; Yxy

Color Differences ΔE^* ; $\Delta E(h)$; ΔE_{FMC2} ; ΔE_{94} ; ΔE_{CMC} ; ΔE_{99} ; ΔE_{2000}

Indices YIE313; YID1925; WIE313; CIE; Berger; Color Strength; Opacity; Metamerism; Grayscale; Jetness; ΔF ; ΔE_{zero}

Illuminants A; C; D50; D55; D65; D75; F2; F6; F7; F8; F10; F11; UL30

Observer 2°; 10°

Gloss

Measurement Range 0-10 GU 10-100 GU

Repeatability ± 0.1 GU ± 0.2 GU

Reproducibility ± 0.5 GU ± 1.0 GU

General Data

Memory 5000 Standards and samples

Languages English, German, French, Italian, Spanish, Russian, Japanese, Chinese

Battery 7.2 V, 2350 mAh, 16.92 Wh

Power supply Input 100 - 240 V, 50 - 60 Hz, max. 1 A Output 12 V, max. 3 A

Operating Temperature 10 °C to 40 °C
 (50 °F to 104 °F) for operation
 0 °C to 60 °C
 (32 °F to 140 °F) for storage

Humidity Up to 85 % non-condensing at 35 °C (95 °F)

Dimensions 87 x 110 x 188 mm (3.4 x 4.3 x 7.4 in)

Weight 707 g (d/8), 690 g (45/0)

spectro2guide Training

BYK-Gardner offers you more than just an instrument. We train you on color theory, how to operate spectro2guide and data analysis with smart-chart. Therefore, the instrument comes with a 1-day training course including:

1. Color, Gloss and Fluorescence Theory

- Building blocks of color and gloss:
 - illuminant, observer, object
- Color differences with interpretation
- Fluorescent Measurement and data analysis

2. spectro2guide Operation

- Set-up of instrument
- Operation

3. smart-lab Color training

- Standard management
- Data analysis using standard reports:
 - Scatter graph for P/F color analysis
 - Metamerism graph to judge color match under different illuminants
 - Fluorescence Slider for detailed fluorescence analysis by each excitation range
- Create your own reports in Excel®:
 - Transfer data from the database to Excel®



4. smart-process Color training

- Standard management
- Set-up an "organizer" to create a routine measurement procedure
- Send Organizer to instrument
- Data transfer to smart-chart and saving in a database
- Data analysis using standard reports
 - Test Report of a single test series
 - Scorecard: Executive summary (selected time range)
 - Trend Report of a specific color/ product over specified time range
- Create your own reports in Excel®:
 - Transfer data from the database to Excel®

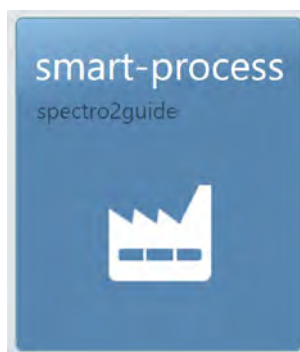

Ordering Information

Cat. No.	Description
7079	Stylus, spectro2guide (10pcs)
7076	Protective Cap, spectro2guide
7077	USB Interface Cable
7078	Online Cable, spectro2guide
7083	Software smart-lab Color, spectro2guide
7084	Software smart-process Color, spectro2guide

Accessories

For touchscreen navigation
Snap on to protect optics and interior components
To connect the docking station to the PC, USB-A plug
To connect the instrument directly to the PC
Software for professional analysis and documentation in the laboratory
Process QC Software for analysis of multi-component products

Accessories for Cosmetics

Measurement of cosmetic products

A uniform, attractive appearance of the products is essential for the customer acceptance. Consistent raw materials and stable process parameters are the key to uniform and repeatable color and appearance quality. For each different product type (e.g. nail polish, lipstick, eye shadow, foundation…) a standardized sample preparation is required in order to guarantee repeatable measurement results.



Measurement of small and/or curved products

Sample Holder Cosmetics

The Sample Holder Cosmetics is especially designed for solid color measurements using spectro2guide on small as well as curved products, e.g.

- Lipsticks
- Artificial Nails
- Cosmetic Packaging such as hairspray cans



For repeatable results the product is placed into a sample drawer, which can be comfortably opened and closed. Magnets keep the drawer from sliding open. A mask is fit on top of the sample drawer to hold the spectro2guide in place and allow non-contact measurements of your products in a completely shielded compartment.

- Easy handling
- Precise and repeatable positioning of sample
- No ambient light
- Durable, easy-to-clean material
- Non-contact measurement

There are three different kits available for use with the Sample Holder Cosmetics depending on which type of product needs to be measured:

Lipstick Kit

- Prismatic clamp for inserting lipsticks with various diameters
- Magnets on the bottom plate provide a reliable locking feature, and allow for simple attachment and removal



Nail Kit

- Exchangeable nail attachment, which is customizable for various nail shapes
- Reliable rigid placement via magnets on bottom plate

Cylinder Kit

- Customizable inlays for various diameters of cylindrical shaped products
- Optimum form closure guarantees tight fit of inlays inside the Sample Holder Cosmetics



Ordering Information

Cat. No.	Description
6469	Sample Holder Cosmetics
6461	Lipstick Kit
6462	Nail Kit
6463	Nail Attachment for 6462
6464	Cylinder Kit

Accessories

Dimensions: 24 x 10 x 10 cm (9.4 x 3.9 x 3.9 in)
 Weight: 2.2 kg (4.9 lbs)
 Max. diameter of lipstick compartment: 20.8 mm
 Please provide sample nail for customization of holder
 Customized nail holder for use with Nail Kit 6462
 Max. length of cylinder: 229 mm
 Max. diameter of cylinder: 67 mm
 Please provide sample for customization of inlays

Measurement of wet drawdowns

Wet Drawdown Template – C

The Wet Drawdown Template – C is especially designed for solid color measurements using spectro2guide on non-drying drawdowns, e.g.

- Drawdowns of Lipstick Paste
- Drawdowns of Liquid Foundation

To simulate how the color of a product will look like when applied, a drawdown is made on a test chart. The template is then placed over the drawdown without touching the surface of the wet sample. For repeatable non-contact measurements, the template is equipped with a mask to hold the spectro2guide.



- Made of easy-to-clean hard-anodized aluminum
- Non-contact measurements ensure clean and fast handling



Ordering Information

Cat. No.	Description
6467	Wet Drawdown Template – C, spectro2guide

Accessories

Dimensions: 10.0 x 10.0 cm (3.94 x 3.94 in)
Min. Film Width: 12 mm (0.47 in)
Max. Film Width: 80 mm (3.15 in)

Info!

Measurement results are greatly affected by application quality. Therefore the use of an automatic film applicator (e.g. byko-drive) is recommended. For more information please refer to the section "Application"

Measurement of powdery or pasty products

Sample Holder Round Dish – C

The Sample Holder Round Dish – C is developed for solid color measurements using spectro2guide on powdery or pasty materials, e.g.

- Pressed Powders
- Creamy Eye Shadows



For repeatable results the product is pressed or poured into a sample dish. During sample preparation of pressed powders, it is important to always maintain the same plunger pressure as well as the same plunger tissue. It is recommended to use a fine-woven fabric to create a smooth, non-textured surface. The holder is equipped with a mask onto which the spectro2guide is placed for non-contact measurements.

- Made of easy-to-clean hard-anodized aluminum
- Non-contact measurement to protect the instrument's optics
- Customized adapter rings are offered to use the holder with custom specific sample dishes



Ordering Information

Cat. No.	Description
6468	Sample Holder Round Dish – C, spectro2guide
6416	Adapter Rings for 6806

Accessories

Including adapter ring and 5 sample dishes ø 35.5 mm, height 4.5 mm
 Measurement distance approx. 1 mm
 Five adapter rings of various sizes
 Please specify diameter (max. size of sample dish: ø 60 mm)

Info!

For further information and best practice examples on your specific application (nails, lips, face, eyes...) please refer to our brochure "QC Solutions for Cosmetics", which can be downloaded from <http://www.byk.com>



In-Store Color Matching

In-store Color Formulation Systems

Increase your efficiency, productivity and profitability with BYK-Gardner's in-store color formulation systems. By improving your customer service you are building up brand loyalty and bring a more professional image to your store. Now you can formulate custom color matches in your store as the customer waits – it only takes a few minutes.

BYK-Gardner's in-store color formulation system provides a complete solution for effective control of your entire color management process:

- Excellent first time custom color matches
- Reduced paint mistints and increased profits
- Electronic competitive fandecks included to increase paint sales by matching competitive colors
- Easy-to-use software that enhances your store's productivity
- Durable and low maintenance instruments
- Paint expertise support
- Paint database creation

A complete color formulation system consists of:

- Spectrophotometer
- In-store color matching software
- PC, monitor, keyboard and printer

BYK-Gardner offers all of the above components in a complete system, or you may elect to provide some of the components yourself. Each component is sold separately or turnkey system pricing can be provided. In addition, we also assist you in selecting an automatic or manual colorant dispenser (not sold by BYK-Gardner) to complete your system.

Need a portable solution?

BYK-Gardner also provides a portable look-up system where up to 4900 color standards can be stored in the instrument memory and an "auto-standard" function will retrieve the closest match. Simply store all fandeck colors in the memory of the spectrophotometer, and you are ready to go.

Or use the instrument to custom match any object on site. Simply measure and store the color, bring the instrument back and have BYK-Gardner's auto-match software generate the match for you.

auto-match[®] III Sensor

The last thing a paint department wants to worry about is a broken down color matching system. Therefore the auto-match III has an extremely rugged and reliable design guaranteeing a maintenance-free operation for years. The instrument uses a 45/0 circumferential illumination in order to match your samples as your eye sees them.

In addition, the auto-match III spectrophotometer offers the following unique benefits:

- Small, compact sensor fits almost anywhere
- No more lost accessories or standards - standards are integrated into the sample clamp
- Temperature stable results without constant calibration - the same matching results are obtained no matter what your store temperature is
- Maintenance is no longer an issue - very low frequency of repair
- Best warranty in the industry - 3-year guarantee on the instrument and 10-year guarantee on the light source
- Excellent inter-instrument agreement - the same accurate results are provided in every store location



Standards

ASTM	D 2244, E 308, E 1164
DIN	5033, 5036, 6174
DIN EN ISO	11664



Ordering Information

Cat. No.	Description
1150	auto-match III 45/0, 115 V
1155	auto-match III 45/0, 230 V

Comes complete with:

Spectrophotometer
Black calibration standard
White calibration standard with certificate
Interface cable

Note: Requires separate purchase of the auto-match retail color matching software Cat. No. 1001 or equivalent in order to operate.

Technical Specifications

	Voltage	Geometry*	Aperture
	115 VAC, 60 Hz	45/0	11 mm
	230 VAC, 50 Hz	45/0	11 mm
Spectral Range	400 - 700 nm, 20 nm resolution		
Repeatability¹	0,01 ΔE* (10 consecutive measurements on white)		
Reproducibility¹	0.20 ΔE* (average on 12 BCRA II tiles)		
Operating Temperature	10 to 42 °C (50 to 110 °F)		
Relative Humidity	up to 85%, 35 °C (95 °F) non-condensing		
Dimensions	14.6 x 13.3 x 24 cm (5.75 x 5.25 x 9.5 in)		
Weight	3.3 kg (7.3 lbs)		

¹ Standard deviation

* Sphere d/8 geometry on request.

auto-match Software

BYK-Gardner's software combines proven reliability with excellent matching performance. The user friendly interface guarantees ease of operation: just choose the product line that you want to use and the software guides you through the process.

The software can be customized to your application. Your company logo on the opening screen, lock out of certain colorants with certain bases, multiple languages, and other custom features can be incorporated into the software, making it truly unique to your stores.

The software offers the following features:

- Custom color matches in less than four seconds
- Electronic formula book - providing a quick and mistake-free look up of any color formulation in your database
- Easy-to-use storage and retrieval of customer history and custom formulas
- Electronic competitive fandecks - providing you with an endless range of hues and shades
- Correction features enable precise match fine tuning to customer desires



Ordering Information

Cat. No.	Description
1001	auto-match RCS Software

Hardware Requirements:

Operating system: Windows 98SE or higher
 Memory: min. 1 GB RAM
 Hard disk capacity: min. 4 GB
 Monitor resolution: VGA or better
 Disk drive: CD-ROM
 Interface: 1 serial port, 6 USB ports
 Printer: Dymo label printer 450 (optional)

Accessories

Cat. No.	Description
1005	Pentium computer w/keyboard
1006	17 in. Flat Screen Monitor
1007	17 in. Monitor
1008	Dymo Label Printer 450

Technical Specifications

Formulation Time	< 4 seconds
Languages	English, French, Spanish, Portuguese (please specify at time of purchase)
Controls	External keyboard and mouse
Dispenser Output	RS232 C
Printer Output	USB
Network Interface	Yes

Introduction

Metallic Coatings

Today effect finishes play a dominant role in many applications as they make an object distinctively appealing.

In contrast to conventional solid colors, effect finishes change their appearance with viewing angle and lighting conditions. Interference finishes show not only a lightness change with different viewing angle, but also a change in chroma and hue. The latest developments are special effect pigments, which create sparkling effects when lighting conditions change from sunlight to cloudy sky.

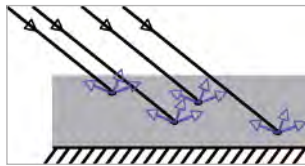

Absorption pigments

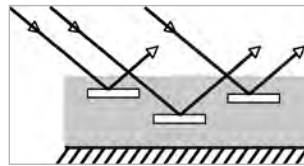

Metallic pigments

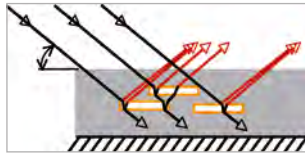

Interference pigments

Courtesy of Merck

Visual Evaluation of Effect Coatings

As metallic finishes show a lightness change with different viewing angles, the sample needs to be tilted to create the same effect during visual evaluation. This effect is also referred to as "light-dark flop". The bigger the lightness changes between the angles of view are, the more the contours of an object will be accentuated. In order to observe color travel of interference finishes, the panel should be moved to allow increasing or decreasing the angle to the light source.

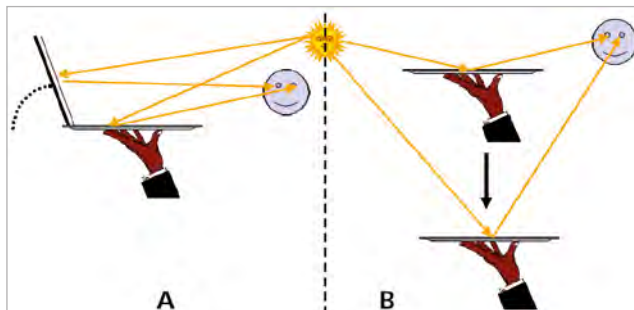

Visual evaluations of traditional metallic finishes

Visual evaluation of effect coatings with color flop

Courtesy of Merck

METALLIC COLOR

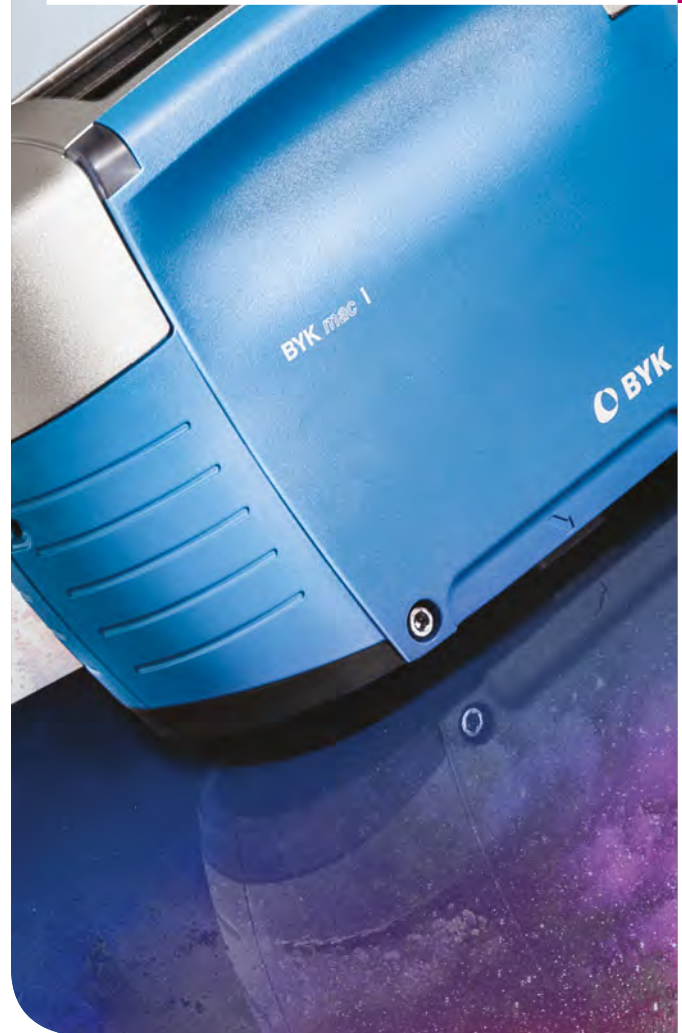

Instrumental Color Measurement of Effect Coatings

Multi-angle color measurement

ASTM, DIN and ISO standards define multi-angle color measurement to objectively describe the color of metallic finishes. Research studies show that a minimum of three, and optimally five viewing angles are needed. The measurement geometry for multi-angle color measurement is specified by aspecular angles. The aspecular angle is the viewing angle measured from the specular direction in the illuminator plane. The angle is positive when measured from the specular direction towards the normal direction.

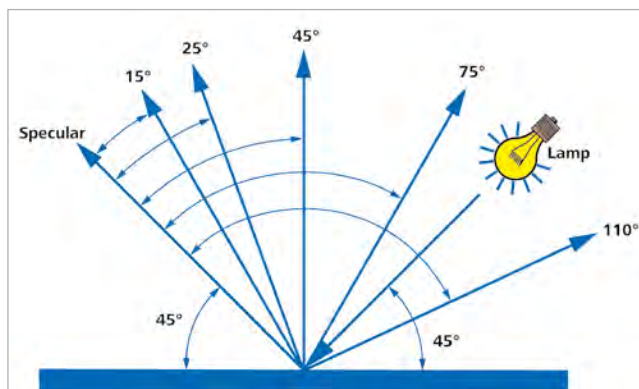

Directional illumination is used versus circumferential illumination because circumferential illumination minimizes the contribution from directional effects such as the Venetian blind effect and surface irregularities. Thus, averaging of the circumferential illumination would cause the measured color values of two specimens to be the same, while visually the two specimens would not match. For color QC, the colorimetric data L^* , a^* , b^* (or L^* , C^* , h°) and ΔE^* can be used. The tolerances are usually higher for the near specular (15° , 25°) and the flop angle (75° , 110°) than the 45° tolerance. In order to have a unique tolerance parameter independent of color, weighted factors have to be used. Therefore, automotive companies often have set specifications on ΔE CMC or $\Delta E'$ based on DIN 6175-2 using 3 or 5 angle instrumentation. Another useful index is the flop index, a measure of the change in lightness of a metallic color as it is tilted through the entire range of viewing angles.

In the last years a new generation of special effect pigments has become more and more popular. For some of these new pigments the color travels over a wide range.

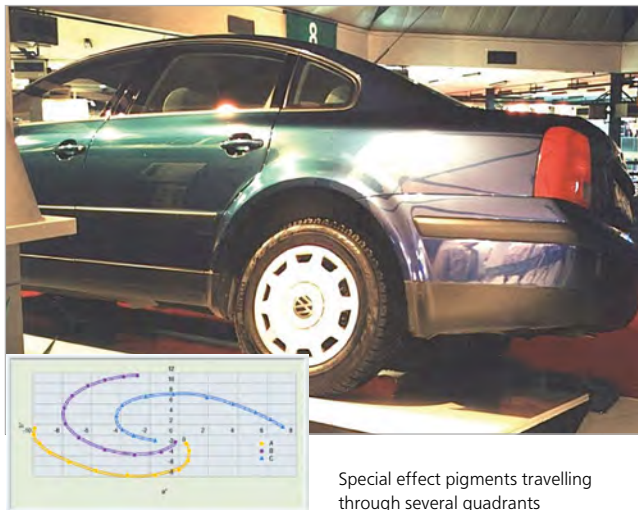

Special effect pigments travelling through several quadrants

In order to fully capture the color travel of these interference pigments it is necessary to add viewing and illumination angles. To keep the whole procedure practical for industrial use with a portable spectrophotometer it was determined that an additional angle behind the gloss e.g. -15° is of benefit.

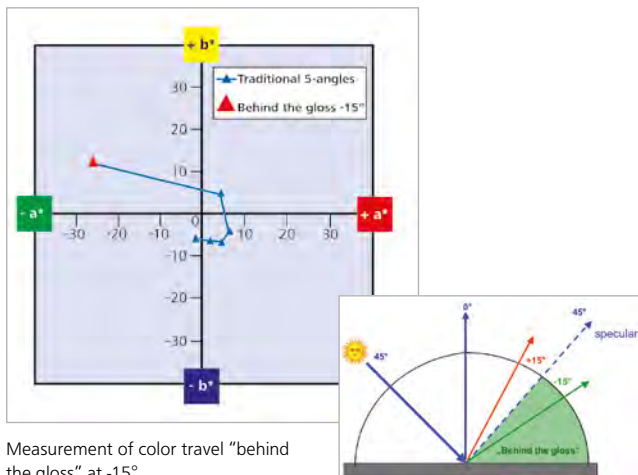

Measurement of color travel "behind the gloss" at -15°

Flake Characterization

In addition to color changes our total perception is also influenced by the effect of the metallic flakes or other sparkling pigments. This effect changes with the lighting conditions, for example direct sunlight versus cloudy sky.



Direct sunlight: Sparkle effect



Cloudy sky: Graininess

Sparkle

A sparkling or glitter impression can be observed under direct sunlight. This effect is often described with different words such as sparkle, micro brilliance or glint and is generated by the reflectivity of the individual effect pigment. Therefore, it is influenced by the

- flake type and size
- concentration level of the effect pigment
- orientation of the effect pigment
- application method

The sparkle impression changes depending on the illumination angle.

Graininess

Apart from the sparkle effect under direct sunlight, another effect can be observed under cloudy conditions, which is described as coarseness or salt and pepper appearance. This visual graininess can be influenced by the flake diameter or the orientation of the flakes resulting in a non-uniform and irregular pattern. The observation angle is of low relevance when evaluating graininess.

Multi-angle color and effect measurement with the BYK-mac i

Traditional 5-angle color measurement calculates color values by averaging the spectral reflection over the entire illuminated spot and therefore can not differentiate between the color of the basecoat and the reflection of the aluminum flakes. As a consequence, two effect finishes can have the same color values with a 5-angle spectrophotometer, but visually appear very different. The visual difference is a result of the flake effects.

Sample 1



Sample 2

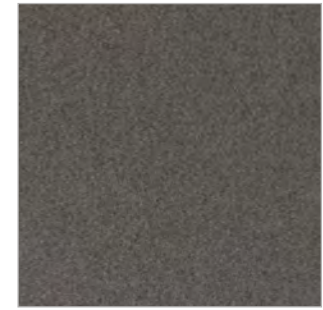

Same color but visual difference

	ΔL^*	Δa^*	Δb^*
-15°	-0.35	0.25	0.42
15°	0.16	0.19	0.43
25°	-0.65	0.20	0.48
45°	-0.10	0.05	0.00
75°	0.46	-0.11	-0.60
110°	0.69	-0.11	-0.89

	$\Delta Sparkle$	$\Delta Graininess$
15°	7.85	
45°	4.17	
75°	1.48	
Diffused		3.81

To characterize the impression of effect finishes under different viewing angles and illumination conditions, the BYK-mac i spectrophotometer objectively measures the total color impression:

- Multi-angle color measurement (6-angles) clearly defines the light-dark as well as color flop behavior of effect finishes
- Sparkling and Graininess control with a high resolution CCD camera simulates effect changes under direct and diffuse lighting conditions

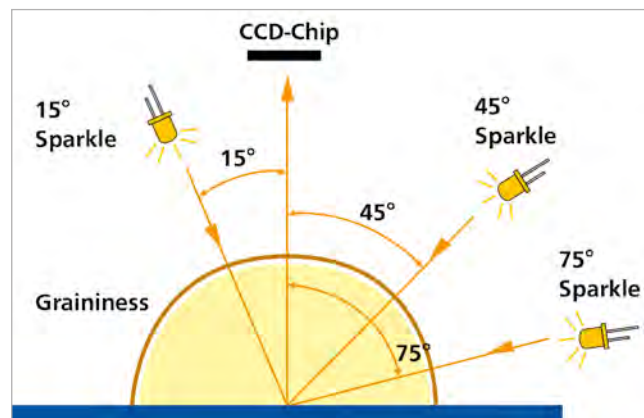

BYK-mac i effect measurement geometries

Sparkle measurement under direct illumination at three angles

The sparkle impression changes with the angle of illumination. Therefore, the BYK-mac i spectrophotometer illuminates the sample under three different angles 15°/45°/75° with very bright LEDs and takes a picture with the CCD camera located at the perpendicular.



Low sparkle (glint)



High sparkle (glint)

The pictures are analyzed by image analyzing algorithms using the histogram of lightness levels as the basis for calculating sparkle parameters.

To allow better differentiation, the impression of sparkle is described by a two dimensional system: sparkle area and sparkle intensity for each angle.

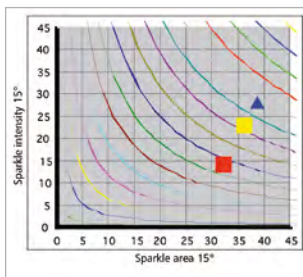

For simplicity sparkle area and intensity are summarized in one value: sparkle grade. Sparkle grade is represented by the colored lines in the diagram.

The sparkle evaluation is done by comparing a sample to a defined standard - like color measurement. Therefore, the sparkle data are also displayed in a difference graph.

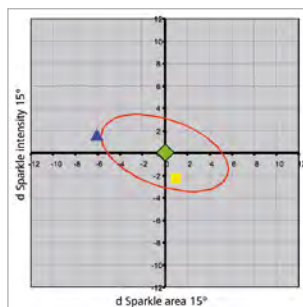

In order to set visually acceptable limits a new sparkle tolerance model was developed together with several partners from the automotive, pigment and paint industry. As a guideline the weighted total color difference equations were used resulting in an elliptical tolerance model.

The human eye is less critical to a change within a sparkle grade than it is to a change from grade to grade. Therefore, the longer axis of the ellipse is towards the sparkle grade lines.

To use the model as a Pass/Fail tool for paint batch or part QC, the total sparkle difference between sample and standard is calculated: $\Delta\text{Sparkle}$.

Graininess measurement under diffused illumination

Graininess is evaluated by taking a picture with the CCD camera under diffused lighting conditions, created by a white coated hemisphere. The picture is analyzed using the histogram of lightness levels whereby the uniformity of light and dark areas is summarized in one graininess value.



Low graininess (coarseness)

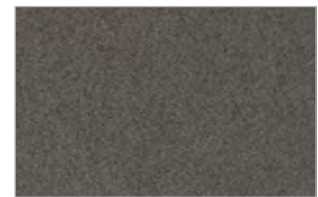

High graininess (coarseness)

A graininess value of zero would indicate a solid color, the higher the value the grainier or coarser the sample will look under diffused light.

Influence of flake size on sparkle and graininess

Sparkle and graininess data give information on flake size and concentration levels. The sample below shows a silver finish with three different flake sizes (25 μm - 34 μm - 54 μm).

Visually, the silver finish with the coarser aluminum pigments appears more sparkling under direct illumination and more "grainy" under diffused lighting.

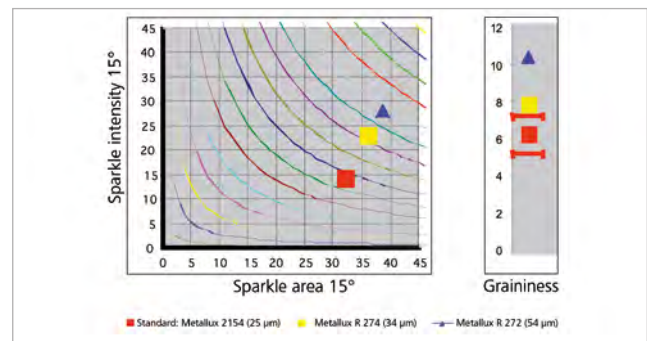

The BYK-mac i measurement correlates with the visual judgment: sparkle area, sparkle intensity and graininess increase with flake size.

Influence of flake orientation on total color impression

Besides flake types and concentration levels, the comparison of sparkle area at 15° and 75° illumination gives information about flake orientation.

Different application method

In order to increase paint efficiency the basecoat application is changing to 100% electrostatic application. Metallic finishes containing coarser aluminum flakes will show more non-parallel oriented flakes. The result will be a lower light-dark flop and more sparkling at a low grazing illumination angle. In the following example the basecoat of the car body was applied 100% electrostatically and the bumpers were painted with a bell / pneumatic application. The total color difference using the mean ΔE_{DIN} was acceptable.

	ΔE_{DIN} avg.
FuelDoor2	0.59
FuelDoor1	0.88
DPillar_R	0.63
DPillar_L	0.56
Door_R	0.53
Door_L	0.62
Bumper_R2	0.56
Bumper_R1	0.40
Bumper_F3	0.89
Bumper_F1	0.87
Bumper_F2	0.90

ΔE_{DIN} is well below one for all measurement points

Yet, visually, the car body was sparkling considerably more than the bumper. The BYK-mac i measurement data reflects the visual impression clearly evaluating the Sparkle 75° data. The Sparkle 75° measurement evaluates the aluminum flakes which are non-parallel oriented; therefore the main changes can be seen in an increasing sparkle area.

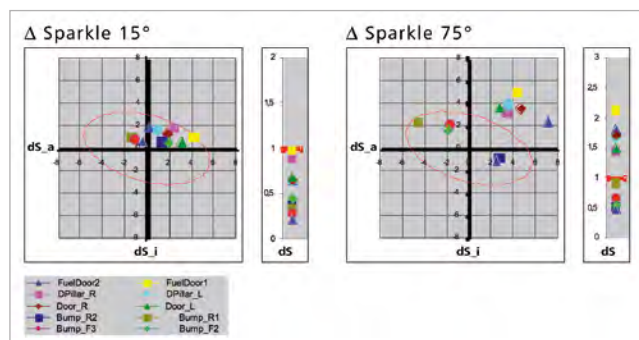

Different rheology additives

Flake orientation can also be influenced by the paint formulation, e.g. the rheology additive. As fine aluminum flakes have more edges and consequently more light is scattered, the orientation is more important for coarser pigments. The use of an optimized rheology additive will result in a better light-dark flop and less sparkling at lower grazing angles.

In the following example a waterborne system was evaluated using three different rheology additives: a standard system, an acrylic thickener and the BYK-Chemie wax additive AQUATIX®. Visually, the three panels look the same under direct illumination at a steep angle. When comparing at a lower grazing angle, the system using the BYK-Chemie wax additive shows less sparkling.

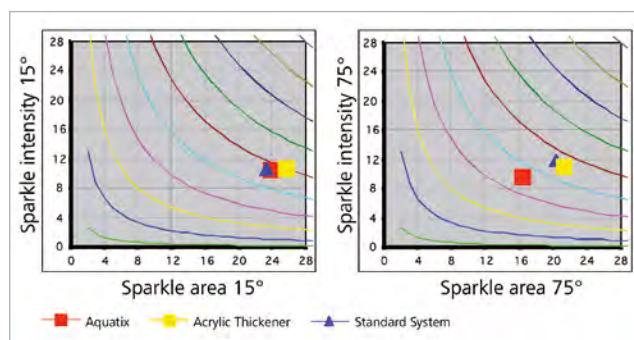

BYK-mac i measurement data correlates with a visual judgment. The sparkle area for the system with wax additive at 75° is smaller than for the two other systems. As Sparkle 75° evaluates flakes which are non-parallel oriented, this clearly shows that by using the BYK-Chemie wax additive AQUATIX® the orientation of the aluminum flakes is improved.



BYK-mac i measures total color impression

Info!

For more information on visual evaluation of effect finishes see byko-spectra effect.

Fluorescence

Fluorescence is the spontaneous emission of light by a substance that has absorbed light. Part of the emitted light is released as heat. Therefore, the fluorescent light is typically of lower energy and thus, longer wavelength than the exciting light.

This phenomenon is called "Stokes Shift" and well known for optical brighteners that absorb light in the UV-range and emit the fluorescent light in the blue wavelength range.

But, it can also occur in the visible range e.g. light excited in the blue wavelength range can be shifted to the green, yellow or red wavelength range.

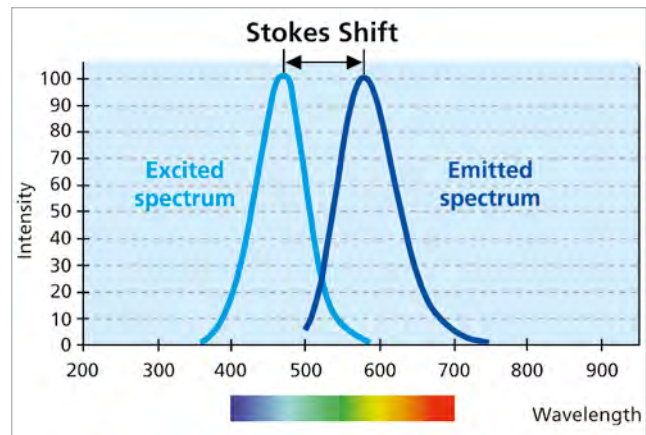

Measurement of Fluorescence

BYK-mac i is the only portable spectrophotometer which can detect fluorescent light excited in the visible range.

BYK-mac i is equipped with additional sensors integrated in the white coated hemispheres of the graininess illumination. These sensors measure the shifted fluorescent light in clearly defined wavelength ranges and allocate it to the respective emission wavelengths.

Due to the highly stable LED illumination fluorescent colors can also be measured repeatable with one BYK-mac (no warm-up time, no temperature drift) and from one BYK-mac to another BYK-mac (no lamp aging).

Additionally, BYK-mac i quantifies the fluorescent light by calculating a new index - the Intensity Emission value.

The Intensity Emission index (Int-Em) can be used as a preliminary indicator for light fastness.

$$Int_{Emission} = 10^4 \frac{\int FI_{Light} d\lambda}{\int PWD d\lambda}$$

PWD = Perfect White Diffuser



BYK-mac i measures total color impression and quantifies fluorescence

BYK-mac i

Total color impression of effect finishes

The appearance of effect finishes is influenced by different viewing angles and viewing conditions. Apart from a light-dark flop and color shift special sparkling effects can be created. The BYK-mac i spectrophotometer is unique as it measures both multi-angle color and flake characterization in one portable device.

- Traditional 5-angle color measurement: 15° / 25° / 45° / 75° / 110°
- Additional color measurement behind the gloss for color travel of interference pigments: -15°
- Sparkle and graininess measurement for flake characterization

Ergonomic design and easy operation

The shape of the instrument is designed to ensure easy handling and true portability. Due to its intuitive menu quality control of metallic finishes has never been easier.

- Menu guided operation according to your own sampling procedure
- Designated buttons for standard and sample readings
- Scroll wheel to select menu functions
- Large color display - easy-to-read inside and outside
- Storage of up to 1000 readings in selectable memories
- smart-chart software for professional analysis, documentation and data management



Hood	D65/10° 3/3				
-15°	ΔL p	Δa p	Δb p	ΔEpD	
15°	0.05	0.11	-0.03	0.12	
25°	0.05	0.08	-0.06	0.11	
45°	-0.14	0.05	-0.11	0.19	
75°	-0.22	0.02	0.13	0.26	
110°	-0.13	0.15	0.32	0.38	
	0.12	0.18	0.34	0.40	
			ΔEt	0.27	
Light Silver Model 1					

Hood	D65/10° 2/2		
ΔSE	ΔEt	ΔSt	
0.23	0.11	0.21	
pass			
Data view			

Reliable readings at any time

In order to guarantee stable positioning, the BYK-mac i is equipped with trigger pins on the bottom plate of the instrument. If the pins do not have contact with the surface, an error message will be displayed. This ensures reproducible results on test panels as well as curved parts ($r > 500$ mm).

Additionally, the surface temperature is measured and saved with each measurement.

Accurate results and low maintenance

The BYK-mac i spectrophotometer uses a light source with long-term stability and patented illumination control which provides superior accuracy and low maintenance for many years.

- Stable, long-term calibration – needed only every three months
- Temperature independent measurement results between 10 - 40 °C - without calibration
- Excellent agreement between instruments allowing usage of digital standards among the supply chain
- 10 year warranty on the light source – no lamp changes needed

Quantification of Fluorescent Light

The BYK-mac i spectrophotometer is equipped with additional sensors to detect fluorescent light excited in the visible range. The Intensity Emission value quantifies the fluorescent light and can be used as a preliminary indicator for light fastness.

Always ready

The instrument is operated with a rechargeable battery pack (Li-Ion). The docking station automatically charges the battery pack in the instrument as well as a spare pack located in the docking station.

Optionally the instrument can be operated with 4 standard mignon alkaline or rechargeable batteries.

The docking station also transfers measured data to a PC.



Plug-in WiFi Adapter

New!

Do you want to be as flexible as possible when transferring data? The new plug-in WiFi adapter is an optional accessory that can be easily attached to the interface port of the BYK-mac i. Setting-up your own network within a blink of an eye guarantees flawless data transfer which is not tied down by a cable anymore.



Ordering Information

Cat. No.	Description
7052	WiFi Adapter BYK-mac i

Technical Specifications

Plug-in adapter to set-up wireless data transfer to a PC

BYK-mac i with small aperture

Measurement of effect finishes on small or curved parts

Special effect finishes are used in many applications to create new color impressions pronouncing the design of a product. Objects like mobile phone housings, bicycles or window handles are very small or curved. They require a color instrument with small aperture and repeatable sample placement.

BYK-mac i with 12 mm aperture guarantees repeatable results even on such products.

Total color impression of effect finishes

- 5-angle color measurement for light/dark travel evaluation: 15° / 25° / 45° / 75° / 110°
- Additional color measurement behind the gloss for color flop analysis: -15°
- Sparkle and graininess measurement for flake characterization



Easy operation and efficient data analysis

The shape of the instrument is designed to ensure easy handling and true portability. Due to its intuitive menu quality control of small parts has never been easier.

- Menu guided operation according to your own sampling procedure
- Large color display – easy-to-read inside and outside
- Storage of up to 1000 readings in selectable memories
- Professional data documentation and analysis with smart-chart software



Accurate results and low maintenance

The BYK-mac i 12 mm uses a light source with long-term stability and a patented illumination control which provides superior accuracy and low maintenance.

- Stable, long-term calibration – needed only every three months
- Temperature independent measurement results between 10 - 40°C - without calibration
- 10 year warranty on LED light source – no lamp changes needed
- Excellent agreement between instruments allowing usage of digital standards among the supply chain
- Operated by a rechargeable battery pack – good for 1000 readings

Quantification of Fluorescent Light

The BYK-mac i 12 mm spectrophotometer is equipped with additional sensors to detect fluorescent light excited in the visible range. The Intensity Emission value quantifies the fluorescent light and can be used as a preliminary indicator for light fastness.

Plug-in WiFi Adapter

New!

Do you want to be as flexible as possible when transferring data? The new plug-in WiFi adapter is an optional accessory that can be easily attached to the interface port of the BYK-mac i. Setting-up your own network within a blink of an eye guarantees flawless data transfer which is not tied down by a cable anymore.



Reliable readings for various sample sizes

- 4 pin positioning for minimum sample size of 35 x 45 mm which can be varied by check zone depending on curvature

Optional sample holder for small parts

The holder is equipped with a mask to fit the aperture of the BYK-mac i 12 mm and a tilting handle to fix the instrument. Therefore, repeatable sample placement and reliable measurement results are guaranteed.

- Application specific presentation tools:
 - Flexible sample table
 - Sample pin
 - Positioning tool for centering sample
- Minimum sample size: \varnothing 30 mm
- Maximum distance between measurement spot and back rail: 50 mm



Flexible sample table for measuring e.g. headlamp cleaning device covers



Sample pin for measuring e.g. distance sensor covers

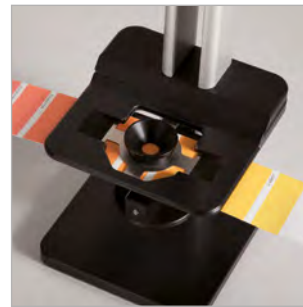

Positioning tool to center sample



Ordering Information

Cat. No.	Description
6408	Sample Holder BYK-mac 12 mm

Comes complete with:

Sample holder
Flexible sample table
Sample pin
Positioning tool
Short Instructions

Technical Specifications

Dimensions	Weight
130 x 140 x 263 mm (5.1 x 5.2 x 10.4 in)	1,7 kg (3.75 lbs)

In compliance with:

Standards

ASTM	D 2244, E 308, E 1164, E 2194
DIN	5033, 5036, 6174, 6175-2
DIN EN ISO	11664
SAE	J 1545



Ordering Information

Cat. No.	Description
7030	BYK-mac i 23 mm
7034	BYK-mac i 12 mm
7031	BYK-mac i Sensor 23 mm
7035	BYK-mac i Sensor 12 mm

Comes complete with:

Multi-angle spectrophotometer
Black calibration standard
White calibration standard with certificate
Color and effect checking reference
Protective cap
Cleaning set for bottom plate
2 light protection covers
Seal replacement kit
Docking station with USB cable for memory transfer
Instrument interface cable for online data transfer
2 rechargeable Li-ion battery packs
Battery holder; 4 x AA batteries
Short instructions; Operating manual on CD
Carrying case; Training
Software for download (7030 and 7034 only):
smart-lab Color or smart-process with 2 licenses

Note: After software download both software packages can be used for 30 days free trial. Thereafter, the user needs to decide and register for one software package

System Requirements:

Operating system: Windows 7 SP1, 8.1 or 10
Microsoft® .NET Framework 4.5.2
Hardware: Core 2 Duo, 2.2 GHz; i7, 2.5 GHz recommended, or equivalent
Memory: 4 GB RAM, 8 GB recommended
Hard-disk capacity: 2 GB during installation
Monitor resolution: 1280 x 1024 pixel or higher
Interface: free USB-port

Technical Specifications

Measuring Area	
23 mm diameter	
12 mm diameter	
23 mm diameter	
12 mm diameter	
Color	
Measuring Geometry	45° illumination -15°, 15°, 25°, 45°, 75°, 110° aspectual viewing
Spectral Range	400 - 700 nm, 10 nm resolution
Measurement Range	0 to 600 % reflectance
Repeatability	0.01 ΔE^* (10 consecutive measurements on white)
Reproducibility	Grey BCRA tiles: avg. $\Delta E^* < 0.10$ Chromatic BCRA tiles: avg. $\Delta E^* < 0.25$
Color Scales	ΔE^* ; ΔE CMC; ΔE 94; ΔE 2000; ΔE 99; ΔE DIN6175
Index	Flop, Int-Em
Illuminants	A; C; D50; D65; F2; F7; F11; F12
Observer	2°; 10°
Effect	
Measurement Geometry	15° / 45° / 75° and diffused illumination perpendicular viewing
Effect Parameters	ΔS ; ΔS_a ; ΔS_i ; ΔG
Repeatability	S_a / S_i : 5% or $> 0.50 / G = \pm 0.05$
Reproducibility	S_a / S_i : 10% or $> 1.00 / G = \pm 0.15$
Measuring Time	< 6 seconds
Memory	1000 standards / samples
Display	2.7 in. TFT color LCD display
Language	English, French, German, Italian, Japanese, Spanish
Power Supply	Rechargeable battery pack or 4 mignon AA batteries (alkaline or rechargeable)
Operating Temperature	10 to 42° C (50 to 110 ° F)
Relative Humidity	up to 85%, 35° C (95° F); non-condensing
Dimensions	21.8 x 8.1 x 14.7 cm (8.6 x 3.2 x 5.8 in.)
Weight	approx. 1.3 kg (approx. 2.86 lbs)

BYK-mac i Training

BYK-Gardner offers you more than just an instrument. We assist you in analyzing your color readings as well as sparkle and graininess data. As a result you will be able to use the BYK-mac i to save time and money, while at the same time improving quality. Therefore, the instrument comes with a one day training course including:

1. Color and Effect Theory

- Parameters influencing total color impression of effect finishes
- Color and effect differences for trouble shooting

2. Operation and Software training smart-process

- Standard management
- Set-up an "organizer" to create a routine measurement procedure
- Programming of the instrument with "organizer" and measurement of several samples
- Data transfer to smart-chart software and saving in a database for routine QC
- Data analysis using standard reports:
 - Test Report:
Shows measurement data for a single test series - ideal for color harmony reviews
 - Scorecard (Management Summary Report):
Quick overview how production is running over the selected time range
 - Trend Report:
Typical process control chart showing the data over time or by individual.
- Create your own reports reports in Excel®:
 - Transfer data from the database to Excel®

2. Operation and Software training smart-lab

- Standard management
- Measure standards and samples by single and average readings
- Save, recall and delete measurements
- Change illuminants, observers, color equations
- Data analysis using standard reports:
 - Scatter graph per angle to show at one glance whether all parts are within specification
 - Color & Effect Travel to show how individual samples perform per measurement angle
 - Effect graph to control whether sparkle and graininess values are within specification
 - Spectral curves for detailed analysis
- Create your own reports in Excel®:
 - Transfer data from the database to Excel®

The training can be performed in one day or two half days. It is recommended to split the training into two half days:

- Day 1: Theory and basic operation (set-up organizer, taking readings and saving in a database)
- Day 2: 3-4 weeks later to ensure readings were taken and saved in a database. Data analysis and standard QC report can be explained using custom specific data.



Ordering Information

Cat. No.	Description
7044	Black Standard, BYK-mac i
6336	Protective Cap, BYK-mac 23 mm
6399	Protectice Cap, BYK-mac 12 mm
6360	Docking Station, BYK-mac
6337	USB Interface Cable
6413	Online Cable, BYK-mac
7052	WiFi Adapter BYK-mac i
6359	Battery Pack, BYK-mac
6364	Cleaning Set, BYK-mac
6414	Light Protection Cover, BYK-mac
6348	Seal Set, BYK-mac
4862	Software smart-lab Color, BYK-mac i
4831	Software smart-process

Accessories

To perform zero calibration
Snap on cover to protect optics and interior components
Snap on cover to protect optics and interior components
Incl. USB interface cable and charger 100 - 240 V self adapting (For BYK-mac with catalog number 6340 and 6345, please contact customer service for an upgrade package)
To connect the docking station to the PC, USB-A plug, 3 m length
To connect the instrument directly to the PC
Plug-in connector to set-up wireless data transfer to a PC
Rechargeable battery pack for automatic charge in docking station
To clean instrument aperture and pin covers from dust and grease
To measure very bright colors; 10 pieces included
Including 3 light protection rubber seals and 8 rubber pin covers
Lab QC software for online color & effect control with BYK-mac i
Process QC software for BYK-mac i, cloud-runner and wave-scan

Note: For replacement of white, color or effect standard, please contact your local service department.

Accessories for Cosmetics

Measurement of cosmetic products

The cosmetic industry is very much driven by aesthetics. Special effect pigments are used to create colorful and glamorous looks. Colors will show light/dark or color travel depending on viewing angle/curvature as well as sparkle impressions depending on the lighting conditions. For each different product type (e.g. nail polish, lipstick, eye shadow, foundation) a standardized sample preparation is required in order to guarantee repeatable measurement results.

Measurement of small and/or curved products

Sample Holder Cosmetics

The Sample Holder Cosmetics is especially designed for multi-angle color & effect measurements using BYK-mac i 12 mm on small as well as curved products, e.g.

- Lipsticks
- Artificial Nails
- Cosmetic Packaging such as hairspray cans



For repeatable results the product is placed into a sample drawer, which can be comfortably opened and closed. Magnets keep the drawer from sliding open. A mask is fit on top of the sample drawer to hold the BYK-mac i in place and allow non-contact measurements of your products in a completely shielded compartment.

- Easy handling
- Precise and repeatable positioning of sample
- No ambient light
- Durable, easy-to-clean material
- Non-contact measurement

There are three different kits available for use with the Sample Holder Cosmetics depending on which type of product needs to be measured:

Lipstick Kit

- Prismatic clamp for inserting lipsticks with various diameters
- Magnets on the bottom plate provide a reliable locking feature, and allow for simple attachment and removal



Nail Kit

- Exchangeable nail attachment, which is customizable for various nail shapes
- Reliable rigid placement via magnets on bottom plate

Cylinder Kit

- Customizable inlays for various diameters of cylindrical shaped products
- Optimum form closure guarantees tight fit of inlays inside the Sample Holder Cosmetics
- Depending on the size of the sample, the BYK-mac i with 23 mm aperture can also be used



Ordering Information

Cat. No.	Description
6469	Sample Holder Cosmetics
6461	Lipstick Kit
6462	Nail Kit
6463	Nail Attachment for 6462
6464	Cylinder Kit

Accessories

Dimensions: 24 x 10 x 10 cm (9.4 x 3.9 x 3.9 in.)

Weight: 2.2 kg (4.9 lbs)

Max. diameter of lipstick compartment: 20.8 mm

Please provide sample nail for customization of holder

Customized nail holder for use with Nail Kit 6462

Max. length of cylinder: 229 mm

Max. diameter of cylinder: 67 mm

Please provide sample for customization of inlays

Measurement of low viscosity products

Sample Holder Liquid Paste – M

The Sample Holder Liquid Paste – M allows multi-angle color & effect measurements using BYK-mac i on products of low viscosity, e.g.

- Pigment Pastes
- Liquid Foundations

For repeatable results it is important to always pour the same amount of liquid paste into the plastic spoon by means of e.g. a syringe. Care must be taken to achieve a smooth and homogeneous surface. The plastic spoon is fixed in the sample holder and the BYK-mac i is placed on a mask to ensure centered positioning.



- Durable, easy-to-clean material
- Light barrier avoids entry of ambient light
- Non-contact measurements ensure clean and fast handling



Ordering Information

Cat. No.	Description
6439	Sample Holder Liquid Paste – M

Accessories

Including 5 plastic spoons
Measurement distance approx. 1 mm

Measurement of wet drawdowns

Wet Drawdown Template – M

The Wet Drawdown Template – M is especially designed for multi-angle color & effect measurements using BYK-mac i on non-drying drawdowns, e.g.

- Drawdowns of Lipstick Paste
- Drawdowns of Liquid Foundation

To simulate how the color and effect of a product will look like when applied, a drawdown is made on a test chart. The template is then placed over the drawdown without touching the surface of the wet sample. For repeatable non-contact measurements, the template is equipped with a mask to hold the BYK-mac i.

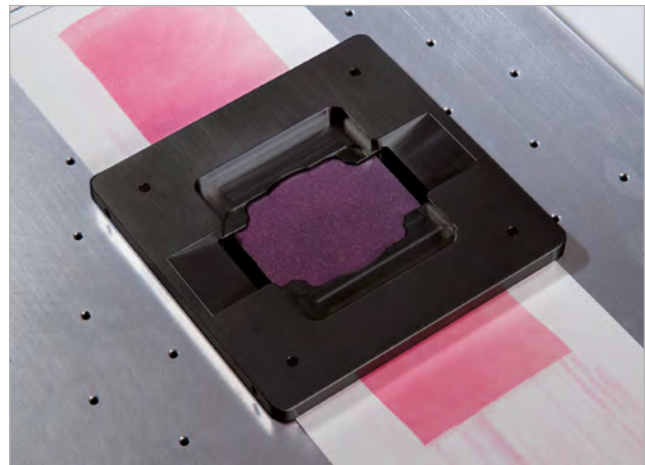

- Made of easy-to-clean hard-anodized aluminum
- Non-contact measurements ensure clean and fast handling



Ordering Information

Cat. No.	Description
6440	Wet Drawdown Template – M

Accessories

Dimensions: 10.0 x 10.0 cm (3.94 x 3.94 in.)
Min. Film Width: 35 mm (1.38 in.)
Max. Film Width: 80 mm (3.15 in.)

Info!

Measurement results are greatly affected by application quality. Therefore the use of an automatic film applicator (e.g. byko-drive) is recommended. For more information please refer to the section "Application".

Measurement of powdery or pasty products

Sample Holder Round Dish – M

The Sample Holder Round Dish – M is developed for multi-angle color & effect measurements using BYK-mac i on powdery or pasty materials, e.g.

- Pressed Powders
- Creamy Eye Shadows

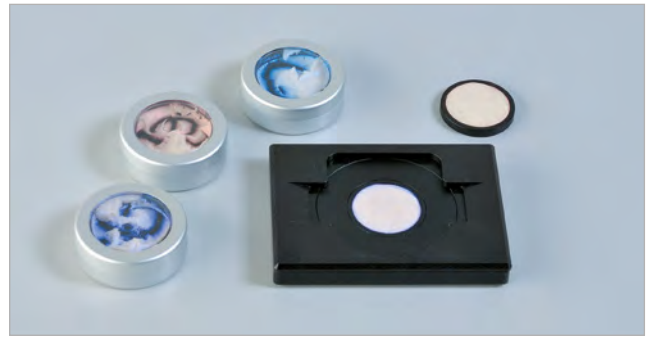

For repeatable results the product is pressed or poured into a sample dish. During sample preparation of pressed powders, it is important to always maintain the same plunger pressure as well as the same plunger tissue. It is recommended to use a fine-woven fabric to create a smooth, non-textured surface. The holder is equipped with a mask onto which the BYK-mac i is placed for non-contact measurements.

- Made of easy-to-clean hard-anodized aluminum
- Non-contact measurement to protect the instrument's optics
- Customized adapter rings are offered to use the holder with custom specific sample dishes



Ordering Information

Cat. No.	Description
6415	Sample Holder Round Dish – M
6416	Adapter Rings for 6415

Accessories

Including adapter ring and 5 sample dishes ø 35.5 mm, height 4.5 mm
Measurement distance approx. 1 mm
Five customized adapter rings of various sizes
Please specify diameter (max. size of sample dish: ø 60 mm)

Info!

For further information and best practice examples on your specific application (nails, lips, face, eyes...) please refer to our brochure "QC Solutions for Cosmetics", which can be downloaded from <http://www.byk.com>

BYK-mac i COLOR

Multi-angle color measurement

In order to control the lightness and / or color flop of an effect finish, the color needs to be measured under different viewing angles.

BYK-mac i COLOR spectrophotometer offers an attractive solution by measuring

- Traditional 5-angle color at 15°/25°/45°/75°/110°
- An additional angle at -15° "behind the gloss" for color travel of interference pigments

Ergonomic design and easy operation

The shape of the instrument is designed to ensure easy handling and true portability. With an intuitive menu quality control of metallic finishes has never been easier.

- Menu guided operation according to your own sampling procedure
- Designated buttons for standard and sample readings
- Scroll wheel to select menu functions
- Large color display - easy-to-read inside and outside
- Storage of up to 1000 readings in selectable memories
- 4 trigger pins on the bottom plate guarantee stable positioning even on curved surfaces



Measure		Hood D65/10° 3/3				
-Model 1						
-Light Silver						
-Line 1		-15°	0.05	0.11	-0.03	0.12
-Line 2		15°	0.05	0.08	-0.06	0.11
Delete		25°	-0.14	0.06	-0.11	0.19
Data view		45°	-0.22	0.02	0.13	0.26
Setup		75°	-0.13	0.15	0.32	0.38
		110°	0.12	0.18	0.34	0.40
					ΔEt	0.27

STANDARD 02 Difference Light Silver Model 1



New!

Plug-in WiFi adapter for flexible and flawless data transfer (see BYK-mac i).

Reliable readings at any time

The BYK-mac i COLOR uses a light source with long term stability and patented illumination control which provide superior accuracy and low maintenance for many years.

- Stable, long-term calibration – needed only every three months
- Temperature independent measurement results between 10 - 40°C - without calibration
- Excellent agreement between instruments allowing usage of digital standards among the supply chain
- 10 year warranty on the light source – no lamp changes needed

Quantification of Fluorescent Light

The BYK-mac i COLOR spectrophotometer is equipped with additional sensors to detect fluorescent light excited in the visible range. The Intensity Emission value quantifies the fluorescent light and can be used as a preliminary indicator for light fastness.

Always ready

The instrument is operated with a rechargeable battery pack (Li-Ion). The docking station automatically charges the battery pack in the instrument as well as a spare pack located in the docking station.

Optionally the instrument can be operated with 4 standard mignon alkaline or rechargeable batteries.

The docking station also transfers the measured data to a PC. For professional analysis, documentation and data management smart-chart software is included.

In compliance with:

Standards

ASTM	D 2244, E 308, E 1164, E 2194
DIN	5033, 5036, 6174, 6175-2
DIN EN ISO	11664
SAE	J 1545



Ordering Information

Cat. No.	Description
7032	BYK-mac i COLOR
7033	BYK-mac i COLOR Sensor

Comes complete with:

- Multi-angle spectrophotometer
- Black calibration standard
- White calibration standard with certificate
- Color checking reference
- Protective cap
- Cleaning set for bottom plate
- 2 light protection covers
- Seal replacement kit
- Docking station with USB cable for memory transfer
- Instrument interface cable for online data transfer
- 2 rechargeable Li-ion battery packs
- Battery holder; 4 x AA batteries
- Short instructions; Operating manual on CD
- Carrying case; Training
- Software for download (7032 only): smart-lab Color or smart-process with 2 licenses

Note: After software download both software packages can be used for 30 days free trial.

Thereafter, the user needs to decide and register for one software package

System Requirements:

- Operating system: Windows 7 SP1, 8.1 or 10
- Microsoft® .NET Framework 4.5.2
- Hardware: Core 2 Duo, 2.2 GHz; i7, 2.5 GHz recommended, or equivalent
- Memory: 4 GB RAM, 8 GB recommended
- Hard-disk capacity: 2 GB during installation
- Monitor resolution: 1280 x 1024 pixel or higher
- Interface: free USB-port

Technical Specifications

Measuring Geometry	45° illumination -15°, 15°, 25°, 45°, 75°, 110° aspecular viewing
Measuring Area	23 mm diameter
Spectral Range	400 - 700 nm, 10 nm resolution
Measurement Range	0 to 600 % reflectance
Repeatability	0.01 ΔE^* (10 consecutive measurements on white)
Reproducibility	Grey BCRA tiles: avg. $\Delta E^* < 0.10$ Chromatic BCRA tiles: avg. $\Delta E^* < 0.25$
Color Scales	ΔE^* ; ΔE CMC; ΔE 94; ΔE 2000; ΔE 99; ΔE DIN6175
Index	Flop, Int-Em
Illuminants	A; C; D50; D65; F2; F7; F11; F12
Observer	2°; 10°
Measuring Time	< 4 seconds
Memory	1000 standards / samples
Display	2.7 in. TFT color LCD display
Language	English, German, French, Italian, Japanese, Spanish
Power Supply	Rechargeable battery pack or 4 mignon AA batteries (alkaline or rechargeable)
Operating Temperature	10 to 42° C (50 to 110 ° F)
Relative Humidity	up to 85%, 35° C (95° F); non-condensing
Dimensions	21.8 x 8.1 x 14.7 cm (8.6 x 3.2 x 5.8 in.)
Weight	approx. 1.3 kg (approx. 2.86 lbs)

BYK-mac i COLOR Training

BYK-Gardner offers you more than just an instrument. We assist you in analyzing your color readings to enable you to use the BYK-mac i COLOR to save time and money, while at the same time improving quality. Therefore, the instrument comes with a one day training course including:

1. Color Theory

- Parameters influencing color impression of effect finishes
- Color differences for trouble shooting

2. Operation and Software training *smart-process*

- Standard management
- Set-up an "organizer" to create a routine measurement procedure
- Programming of the instrument with "organizer" and measurement of several samples
- Data transfer to smart-chart software and saving in a database for routine QC
- Data analysis using standard reports:
 - Test Report: Shows measurement data for a single test series – ideal for color harmony reviews
 - Scorecard (Management Summary Report): Quick overview how production is running over the selected time range
 - Trend Report: Typical process control chart showing the data over time or by individual.
- Create your own reports in Excel®
 - Transfer data from the database to Excel®

The training can be performed in one day or two half days.

It is recommended to split the training into two half days:

Day 1: Theory and basic operation (set-up organizer, taking readings and saving in a database)



2. Operation and Software training *smart-lab*

- Standard management
- Measure standards and samples by single and average readings
- Save, recall and delete measurements
- Change illuminants, observers, color equations
- Data analysis using standard reports:
 - Scatter graph per angle to show at one glance whether all parts are within specification
 - Color Travel to show how individual samples perform per measurement angle
 - Spectral curves for detailed analysis
- Create your own reports in Excel®:
 - Transfer data from the database to Excel®

Day 2: 3-4 weeks later to ensure readings were taken and saved in a database. Data analysis and standard QC report can be explained using custom specific data.



Ordering Information

Cat. No.	Description
7044	Black Standard, BYK-mac i
6336	Protective Cap, BYK-mac 23 mm
6360	Docking Station, BYK-mac
6337	USB Interface Cable
7052	WiFi Adapter BYK-mac i
6359	Battery Pack, BYK-mac
6364	Cleaning Set, BYK-mac
6348	Seal Set, BYK-mac
6414	Light Protection Cover, BYK-mac
4831	Software smart-process
4862	Software smart-lab Color, BYK-mac i

Accessories

To perform zero calibration
Snap on cover to protect optics and interior components
Incl. USB interface cable and charger 100 - 240 V self adapting
To connect the docking station to the PC, USB-A plug, 3 m length
Plug-in connector to set-up wireless data transfer to a PC
Rechargeable battery pack for automatic charge in docking station
To clean instrument aperture and pin covers from dust and grease
Including 3 light protection rubber seals and 8 rubber pin covers
To measure very bright colors; 10 pieces included
Process QC software for BYK-mac i, cloud-runner and wave-scan
Lab QC software for online color & effect control with BYK-mac i

Note: For replacement of white and color standard, please contact your local service department.

BYK-mac i ROBOTIC

Automatic measurement of total color impression of effect finishes at the line

Products can only be manufactured with uniform and consistent quality when process stability is guaranteed. Therefore, multi-angle color, sparkle and graininess must be measured on a routine basis. The BYK-mac i ROBOTIC spectrophotometer allows automated total color control as it is mounted on a robotic arm. The robotic system not only measures a high number of cars, but also on the same areas.

Total color impression of effect finishes

The BYK-mac i ROBOTIC measures both multi-angle color and flake characterization.

- Multi-angle color measurement at 6-angles clearly defines the light-dark as well as color flop behavior of effect finishes
- Sparkling and Graininess control with a high resolution CCD camera simulates effect changes under direct and diffuse lighting conditions.
- Multi-angle color and effect data help to analyze the cause of a color mismatch



Reliable and objective color and effect data

The BYK-mac i ROBOTIC spectrophotometer uses a light source with long-term stability and patented illumination control which provide superior accuracy and low maintenance for many years.

- Stable, long-term calibration – needed only every three months
- Temperature independent measurement results between 10 - 40°C - without calibration
- 10 year warranty on light source – no lamp changes needed
- Excellent agreement between instruments and correlation to BYK-mac i and BYK-mac i COLOR



Reliable readings at any time

In order to guarantee stable positioning, the BYK-mac i ROBOTIC is equipped with trigger pins on the bottom plate of the instrument. The sensitivity of the pins can be adjusted to the curvature of the measurement area. If the pins do not have contact with the surface an error message will be displayed.

Quantification of Fluorescent Light

The BYK-mac i ROBOTIC spectrophotometer is equipped with additional sensors to detect fluorescent light excited in the visible range. The Intensity Emission value quantifies the fluorescent light and can be used as a preliminary indicator for light fastness.

In compliance with:

Standards

ASTM	D 2244, E 308, E 1164, E 2194
DIN	5033, 5036, 6174, 6175-2
DIN EN ISO	11664
SAE	J 1545



Ordering Information

Cat. No.	Description
7036	BYK-mac i ROBOTIC

Comes complete with:

Multi-angle spectrophotometer
 White calibration standard with certificate
 Color and effect checking reference
 Light protection cover
 Software smart-chart
 Communication software
 Installation kit
 Operating manual on CD
 Carrying case; Training

Hardware Requirements:

Operating system: Windows 7 SP1, 8.1 or 10
 Microsoft® .NET Framework 4.5.2
 Hardware: Core 2 Duo, 2.2 GHz; i7, 2.5 GHz recommended, or equivalent
 Memory: 4 GB RAM, 8 GB recommended
 Hard-disk capacity: 2 GB during installation
 Monitor resolution: 1280 x 1024 pixel or higher
 Disk drive: CD-ROM or DVD drive

Technical Specifications

Color	
Measuring Geometry	45° illumination -15°, 15°, 25°, 45°, 75°, 110° specular viewing
Measuring Area	87 x 23 mm (3.4 x 0.9 in.)
Spectral Range	400 - 700 nm, 10 nm resolution
Measurement Range	0 to 600 % reflectance
Repeatability	0.01 ΔE* (10 consecutive measurements on white)
Reproducibility	Grey BCRA tiles: avg. ΔE* < 0.10 Chromatic BCRA tiles: avg. ΔE* < 0.25
Color Scales	ΔE*; ΔE CMC; ΔE 94; ΔE 2000; ΔE 99; ΔE DIN6175
Index	Flop, Int-Em
Illuminants	A; C; D50; D65; F2; F7; F11; F12
Observer	2°; 10°
Effect	
Measurement Geometry	15° / 45° / 75° and diffused illumination perpendicular viewing
Effect Parameters	ΔS; ΔS _a ; ΔS _i ; ΔG
Repeatability	S _a / S _i : 5% or > 0.50 / G = ± 0.05
Reproducibility	S _a / S _i : 10% or > 1.00 / G = ± 0.15
Object Curvature	Radius > 400 mm
Measuring Time	< 6 seconds
Memory	1000 standards / samples
Power Supply	External power supply 24 VDC
Interface	RS 422
Robotic Requirements	Vibration-free operation
Operating Temperature	10 to 42° C (50 to 110 ° F)
Relative Humidity	up to 85%, 35° C (95° F); non-condensing
Dimensions	21 x 12.5 x 17.5 cm (8.3 x 5 x 6.9 in.)
Weight	approx.3.5 kg (approx.7.7 lbs)
Dimensions	21 x 12.5 x 17.5 cm (8.3 x 5 x 6.9 in.)
Weight	approx.3.5 kg (approx.7.7 lbs)

BYK-mac i ROBOTIC Training

BYK-Gardner offers you more than just an instrument. We assist you in operating the whole system and analyzing your color, sparkle and graininess data. Therefore, the instrument comes with a two day training course including:

Color and Effect Theory

- Visual perception and instrumental measurement of multi-angle color, sparkle and graininess.
- Data interpretation for trouble shooting
- Support in integrating the BYK-mac i ROBOTIC sensor into an automated measurement system

Software training

- Data analysis using standard reports:
 - Test Report:
Shows measurement data for a single test series – ideal for color harmony reviews
 - Scorecard (Management Summary Report):
Quick overview how production is running over the selected time range
 - Trend Report:
Typical process control chart showing the data over time or by individual.

Day 1: Color and Effect theory with data interpretation for optimization and trouble shooting
Support in integrating the BYK-mac i ROBOTIC sensor into an automated measurement system
Day 2: Software training with data analysis using standard reports



Ordering Information

Cat. No.	Description
6417	Light Protection Cover for 7036
4831	Software smart-process

Accessories

To avoid the influence of ambient light
Process QC software for BYK-mac i ROBOTIC and wave-scan ROBOTIC

Note: For replacement of white, color and effect standard, please contact your local service department.

smart-process

Color and Appearance data in one QC management system

All critical color and appearance parameters can be saved and analyzed with one software package, smart-process.

- Multi-angle color and effect control with BYK-mac i
- Orange peel and Distinctness-of-Image measurement with wave-scan
- Objective mottling analysis with the new cloud-runner

It is smart in more than one way. 6 different apps let you set up a state-of-the-art color & appearance management system.



Standard Management – manage an unlimited number of colors

smart-process includes powerful standard management for defining all essential color and appearance control parameters with Pass / Fail tolerances. Customer specific color and appearance scales for major automotive makers are already predefined and ensure color and appearance control according to their internal specifications.

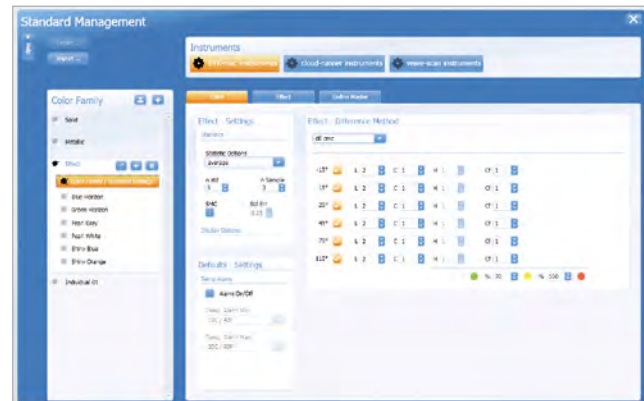

Digital Standard – guarantees a seamless workflow

Thanks to the outstanding inter-instrument agreement of BYK-mac i - proven by all automotive makers and unsurpassed in the industry - smart-process enables you to use "digital standards" on a global basis with your entire supply chain. Export and import your color standards in xml file format and send them by email to your supply chain. Thus, color control data are reliable and communication among all parties is seamless and efficient.

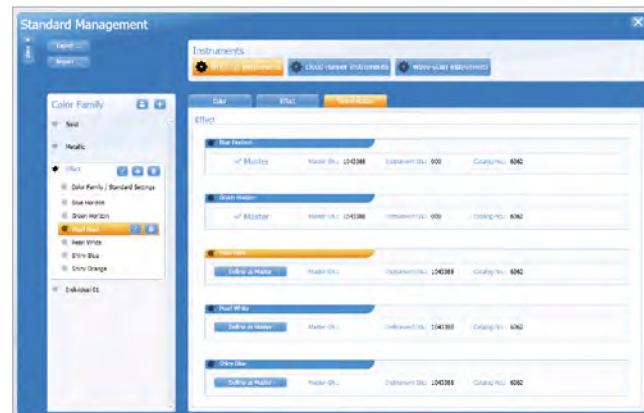

Organizer Set-up – standardized measurement and sample labeling

smart-process offers set-up of Organizers for clear sample identification and a menu guided operation on the instrument. Product schematics help to define specific sampling procedures. The entered parameters can be used for filtering the measured data saved in the database. Typical identifiers are model, color or product ID - smart-process is open for your specific needs.

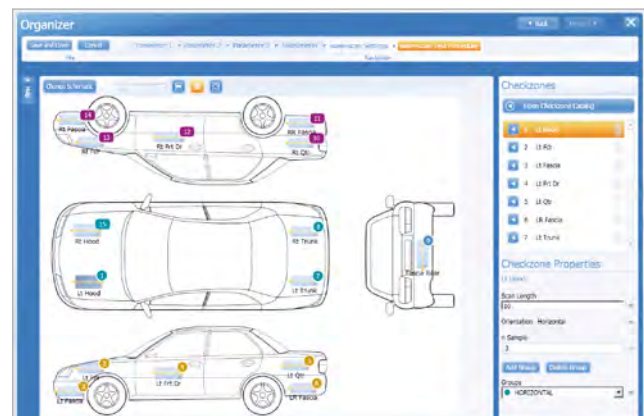

Data Analysis – green light for shipping

Data analysis was never easier. The data are saved in a SQL database which allows handling of large data sets over a long time period. See all your test series at once based on your specific criteria. Select filter criteria, such as a certain time range, a specific color and all “green” or “yellow” or “red” test series for further analysis.

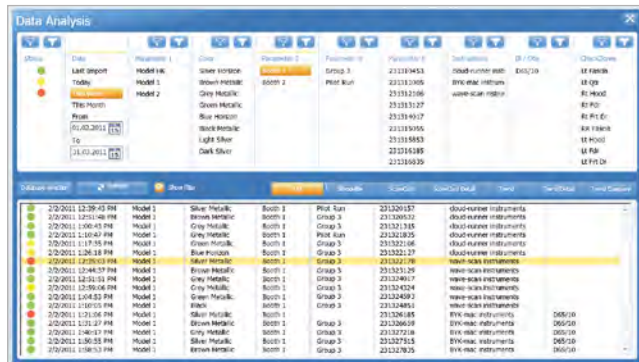

Data analysis – Detailed measurement reports

View and open the measurement data of a single test series with a click. The product schematic quickly shows you where the “problem areas” are. The data is also displayed in an easy-to-read data table highlighting the measurements out of specifications.

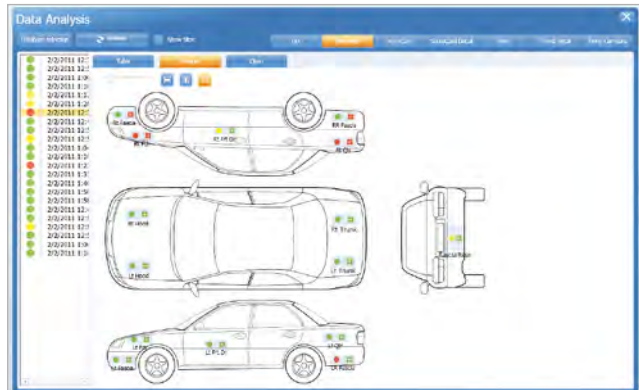

Additionally to the individual test results per check zone, the averages of groups (horizontal or verticals) are calculated and shown on top of the report. In case of color harmony analysis the difference of each check zone to the master standard and the differences between “panel matches” as defined in the organizer are displayed.

Monitor your process and document stability

Innovative data analysis reports feature scorecards with drill-in functionality as well as trend reports for all measured parameters. They are so easy to set up that statistical analysis actually becomes a fun project. And the data is documented and analyzed all together for color and appearance. Valuable time for data crunching will be saved and lengthy discussions analyzing the data will no longer be necessary.

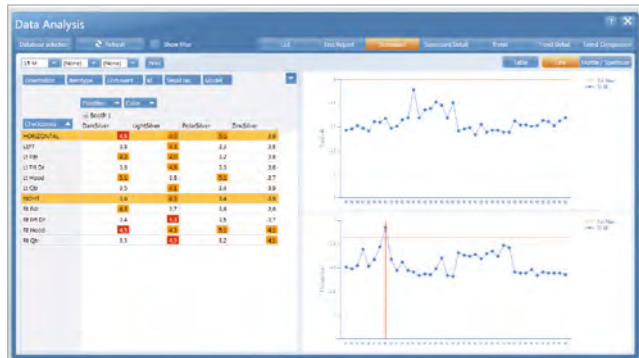

wave-scan Balance-Chart

The Balance chart shows all important info in one report:

- Customer specifications
- Balance chart for visual correlation
- Structure spectrum for optimization

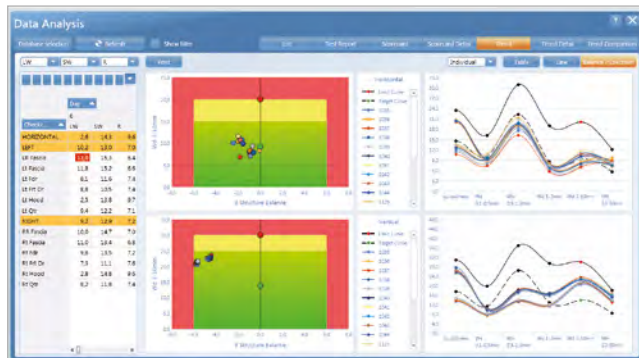

BYK-mac i Color Harmony and Process Control Chart

Lab-Scatter Graph

This standard report shows at a glance whether all parts are within specification. One graph per angle is shown and different tolerance models (e.g. CMC, DIN 6175-2) can be selected.

Effect Graph

Similar to the Lab-scatter graph, this chart easily shows whether effect differences are within tolerance. One graph per sparkle angle and graininess is displayed. Tolerances can be set to your specific requirements.

Color & Effect Travel by Sample

...the ideal tool to show how individual measurement areas or colors perform per measurement angle. In combination with a graph for sparkle and graininess values, total color impression can be easily controlled.

cloud-runner Mottle-Chart

Customer relevant limits for mottling can be defined by setting limits for the Mottling indices. The measured data is displayed in a two-dimensional chart with red - yellow - green ranges for easy process control. In addition, the mottle spectrum gives more detailed information for optimization and trouble shooting.

With smart-process, you'll know where you are, where you're going, and how to get there.

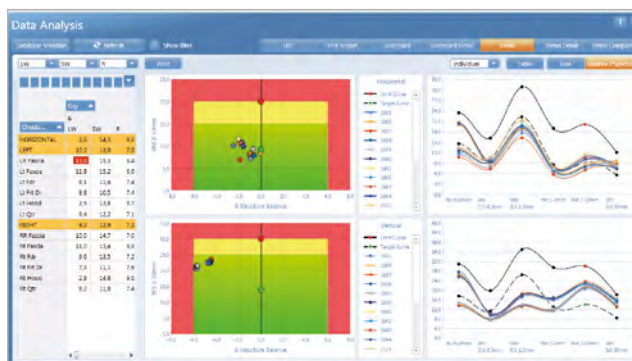
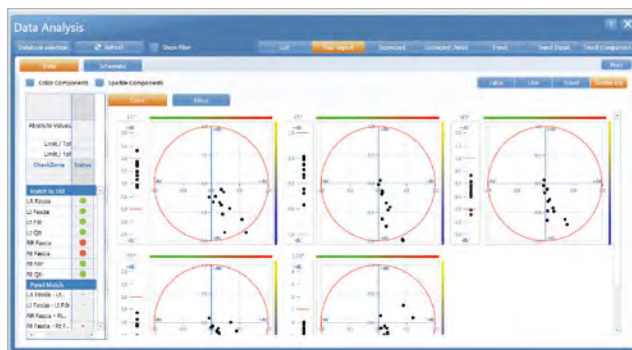

Ordering Information

Cat. No.	Description
4831	Software smart-process

Comes complete with:

Software with 2 licenses for download

Note: smart-process licence fee for more than two installations is quantity dependent. Please contact your local BYK-Gardner representative.

System Requirements:

Operating system: Windows 7 SP1, 8.1 or 10
 Microsoft® .NET Framework 4.5.2
 Hardware: Core 2 Duo, 2.2 GHz; i7, 2.5 GHz recommended, or equivalent
 Memory: 4 GB RAM, 8 GB recommended
 Hard-disk capacity: 2 GB during installation
 Monitor resolution: 1280 x 1024 pixel or higher
 Interface: free USB-port

Technical Specifications

Process QC Software for BYK-mac i, cloud-runner, wave-scan

Instruments	BYK-mac i, BYK-mac i COLOR cloud-runner wave-scan dual, wave-scan II, micro-wave-scan
Export/Import	Color Standard (.xml format) Organizer (.xml format)
Database format	SQL Server Compact
Languages	Chinese, English, French, German, Italian, Japanese, Spanish

smart-lab

Online Color and Effect Control in the laboratory with BYK-mac i

Color and effect control in the laboratory require on one hand open and flexible data analysis and on the other hand efficient data handling of large data sets.



Online Measurement – and instant data analysis

Just connect the BYK-mac i with the PC, measure the master panel, apply the respective tolerances and compare the actual samples against the standard. The data are displayed in a data table with Pass/Fail information and shown in various color graphs. Or recall standard and samples from the database and quickly add new readings.

Popular functions such as saving, deleting or copying can be executed with a right click of the mouse.



Standard Management – extensive flexibility of tolerance methods

smart-lab includes powerful standard management which allows defining Pass / Fail tolerances based on any color control parameter. Besides the commonly available color equations (e.g. CIELAB and CMC), customer specific color scales for all major automotive makers are already predefined and ensure color control according to their internal specifications.

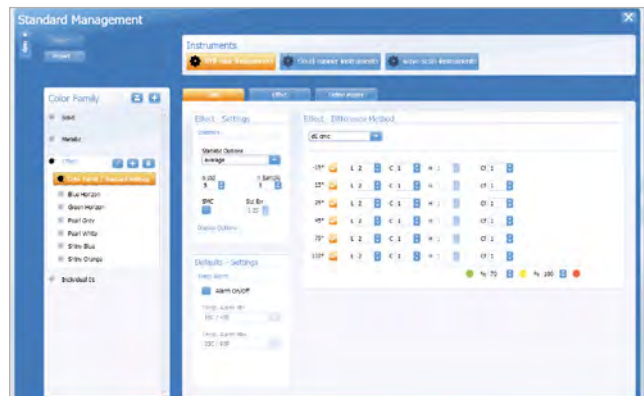

Digital Standard– guarantees a seamless workflow

Thanks to the outstanding inter-instrument agreement of BYK-mac i - proven by all automotive makers and unsurpassed in the industry - smart-lab enables you to use “digital standards” on a global basis with your entire supply chain. Export and import your color standards in xml file format and send them by email to your supply chain. Thus, color control data are reliable and communication among all parties is seamless and efficient.

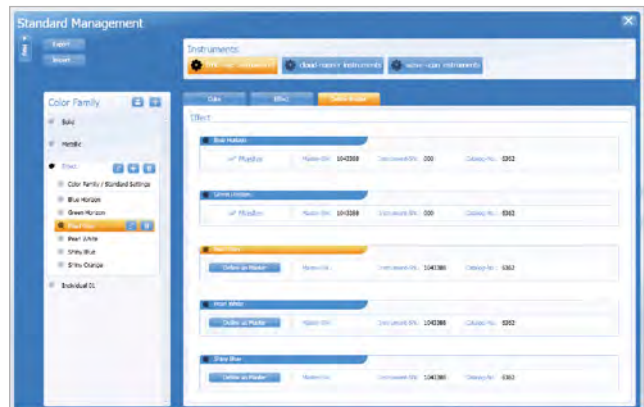

Data analysis – variety of measurement reports

Data analysis was never easier. Results are simultaneously displayed in a data table and a graph highlighting the samples being out of specification.

Easily toggle between measurement conditions like different illuminants and color equations. Multiple settings can even be combined in one project allowing the user to have multiple pass/fail criteria at one glance.

Graphically display color & effect results in the way that works best for your application: scatter plot, line/travel graph and spectral curves can be selected by just a mouse click.



Swap Standard with Sample and vice versa – ultimate flexibility

Interested in how the previous batch compares to the current batch? Just drag & drop the data or even select a sample as the standard. Additionally, it is also possible to calculate the mean value based on a population of samples and use it as a new standard. This is of high interest when selecting a master standard out of a population of standard panels.

Database management – easy and secure

The data are saved in a SQL database which allows handling of large data sets over a long time period. This reliable database type also ensures full network and server compatibility. Retrieve data for further analysis based on your specific filter criteria, such as a specific color or a certain time range. Additionally, current standards and samples can be organized in projects. Projects are saved as xml-files and can be easily shared with other smart-lab users.

With smart-lab, you can start faster and finish sooner without getting lost in details.

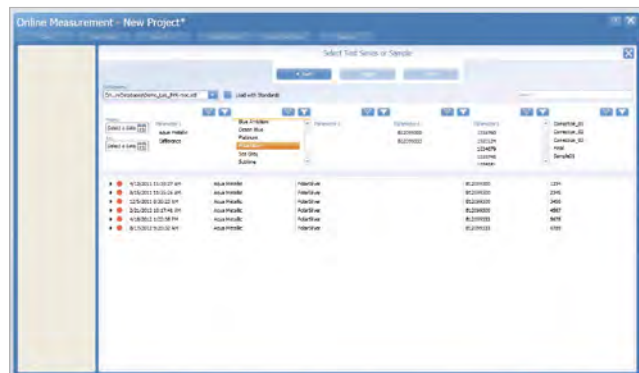

Ordering Information

Cat. No.	Description
4862	Software smart-lab Color, BYK-mac i

Comes complete with:
Software with 2 licenses for download

System Requirements:
Operating system: Windows 7 SP1, 8.1 or 10
Microsoft® .NET Framework 4.5.2
Hardware: Core 2 Duo, 2.2 GHz; i7, 2.5 GHz recommended, or equivalent
Memory: 4 GB RAM, 8 GB recommended
Hard-disk capacity: 2 GB during installation
Monitor resolution: 1280 x 1024 pixel or higher
Interface: free USB-port

Technical Specifications

Lab QC software for online color and effect control with BYK-mac i

Instruments	BYK-mac i, BYK-mac i COLOR
Color Differences	ΔE^* , ΔE_{CMC} , ΔE_{94} , ΔE_{2000} , $\Delta E_{DING175-2}$, custom specific scales
Illuminants	A, C, D50, D65, F2, F7, F11, F12
Observer	2°, 10°
Indices	Metamerism, Color Strength, Flop, Int-Em
Graphs	Scatter plot, line / travel graph, spectral curve
Database format	SQL Server Compact
Export	Project files (.xml format)
Languages	Chinese, English, French, German, Italian, Japanese, Spanish

Note: smart-lab licence fee for more than two installations is quantity dependent. Please contact your local BYK-Gardner representative.



Touch the color with our new spectro2guide:

There it is in black and white: The new spectro2guide has arrived. The revolution in color management.



Upfront design. Color touchscreen. Camera preview. Auto calibration. Gloss. Fluorescence. Digital standard...

www.touchthecolor.com

Introduction

Liquid Color

Color of transparent liquids like varnishes, lacquers, shellacs, drying oils, fatty acids and resin solutions has been evaluated visually since the late 1800s. A change in color can indicate contamination or impurities in the raw materials, process variations caused by heating and oxidation, or degradation of products exposed to weathering over time.

For simplicity, one dimensional scales for yellowness were established, e.g., Gardner Color Scale, American Public Health Association (APHA) and Hazen, Saybolt, and Iodine (Hess-Ives).

In the visual test the yellowness is determined by pouring the sample into a tube and comparing it to a known standard. The standard that the sample falls closest to then becomes the value for the liquid. This procedure is highly subjective due to variations of observers, illumination and to some extent the standards themselves.

Quality control systems like ISO 9000 demand objective measurements using instrumentation that gives reliable data on a consistent basis.

Correlation equations were developed to link visual observations to instrumentally measured values.

Most products are not strictly yellow and therefore require a three dimensional description of color: red/green, yellow/blue and light/dark differences. Modern instruments read this information by the use of standardized color scales like CIE $L^* a^* b^*$ or $L^* C^* h^\circ$.

BYK-Gardner offers a complete line of visual color comparators for quick evaluation, as well as objective instrumentation for liquid color measurement, tolerance setting and pass/fail analysis.



LIQUID COLOR

Liquid Color Standards

The Gardner Liquid Color Standard Comparator provides the entire Gardner Color Scale, against which a liquid sample can be visually compared.

- Rugged design for use in the laboratory and production
- Quick and easy color quality control of liquids
- Attractive price – color evaluation of liquids becomes affordable to everybody
- Shelf-life is 5 years

The sealed tubes are filled with Cobalt Chloride Platinate solutions of varying concentrations, which correspond to known Gardner Scale yellowness value numbers 1 - 18. The solutions are standardized at 25 °C (77 °F), but visual evaluations made between 20 °C (68 °F) and 30 °C (86 °F) are substantially correct.

Two models are available: with or without illumination.

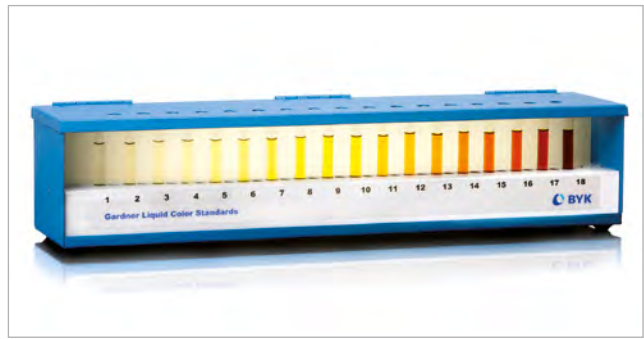

Standards

AOCS	Method Tdla-64T
ASTM	D 1544
ISO	4630



Ordering Information

Cat. No.	Description
6726	Gardner Liquid Standard L 115
6727	Gardner Liquid Standard L 230
6724	Gardner Liquid Standards
6720	Holding rack with illumination
6729	Holding rack without illumination

Technical Specifications

Illumination	Voltage	Dimensions	Weight
Fluorescent Lamp	115 V /	660 x 152 x 152mm (26 x 6 x 6 in)	6.35 kg (14 lbs)
	60 Hz		
Fluorescent Lamp	230 V /	660 x 152 x 152mm (26 x 6 x 6 in)	6.35 kg (14 lbs)
	50 Hz		
		629 x 143 x 64 mm (24.75 x 5 x 2.5 in)	2.3 kg (5 lbs)
Fluorescent Lamp	115-230 V /	629 x 152 x 152 mm (24.75 x 6 x 6 in)	6.0 kg (13.2 lbs)
	50-60 Hz		
		629 x 152 x 152 mm (24.75 x 6 x 6 in)	2.5 kg (5.5 lbs)

Cat. No. 6726 and 6727 come complete with:

Set of 18 color standards 1 to 18
6 empty comparison tubes
Steel holding rack with fluorescent lamp
Operating manual

Cat. No. 6724 comes complete with:

Set of 18 color standards 1 to 18
6 empty comparison tubes
Steel holding rack with frosted glass panel
Operating manual

Accessories

Liquid Standards

Accessories

Cat. No.	Description
6601	Liquid Color Standard No.1
6602	Liquid Color Standard No.2
6603	Liquid Color Standard No.3
6604	Liquid Color Standard No.4
6605	Liquid Color Standard No.5
6606	Liquid Color Standard No.6
6607	Liquid Color Standard No.7
6608	Liquid Color Standard No.8
6609	Liquid Color Standard No.9
6610	Liquid Color Standard No.10
6611	Liquid Color Standard No.11
6612	Liquid Color Standard No.12
6613	Liquid Color Standard No.13
6614	Liquid Color Standard No.14
6615	Liquid Color Standard No.15
6616	Liquid Color Standard No.16
6617	Liquid Color Standard No.17
6618	Liquid Color Standard No.18



The LCM IV provides an objective way to quickly evaluate color of liquids. Please refer to the section LCM IV.

Empty Sample Tubes

Set of 144 empty, unmarked comparison tubes with cork stoppers for the liquid to be tested.

Ordering Information

Cat. No.	Description
6756	Empty Tube Set (144)

*Note: Not applicable for LCM/LCS IV



The LCS IV spectrally measures all color shades and provides detailed color analysis. Please refer to the section LCS IV.

Delta Color Comparator

The Gardner Delta Color Comparator uses precision-polished optical-glass filters as reference standards. Two different models are available: with or without illumination.

- Rugged design allows the color comparator to be used at any location
- Easy operation allows anyone to determine Gardner Color Numbers
- Optional illuminator allows back-light color to improve viewing conditions

The comparator is an arrangement of two wheels in which nine color filters are imbedded in each wheel. The glass filters range in color from water white through deep amber. A tube of the sample liquid is placed between the two filter wheels. The user then rotates the color wheels until the filter glass closest in color to the liquid is in place. That filter notation then becomes the color description for the liquid.



Standards

AOCS	Method Tdla-64T
ASTM	D 1544
ISO	4630



Ordering Information

Cat. No.	Description
6745	Gardner Comparator L, 115V
6746	Gardner Comparator L, 230V
6750	Gardner Comparator

Cat. No. 6745 and 6746 comes complete with:

Gardner Delta Color Comparator assembly
Two reference filter wheels
Gardner Delta illuminator
Operating manual

Technical Specifications

Illumination	Voltage	Dimensions	Weight
Incandescent Lamp	115 V / 60 Hz	171 x 203 x 229 mm	2.7 kg
	100 W	(6.75 x 8 x 9 in)	(6 lbs)
Incandescent Lamp	230 V / 50 Hz	171 x 203 x 229 mm	2.7 kg
	100 W	(6.75 x 8 x 9 in)	(6 lbs)
		159 x 19 x 81 mm	0.45 kg
		(6.25 x 0.75 x 3.2 in)	(1 lbs)

Cat. No. 6750 comes complete with:

Gardner Delta Color Comparator assembly
Two reference filter wheels
Operating manual

Accessories

Cat. No.	Description
6752	Illuminator 115 V
6753	Illuminator 230 V
6754	Incandescent Lamp 115 V for 6745
6405	Incandescent Lamp 230 V for 6746
6756	Empty Tube Set (144)
6761	Filter Wheel, odd numbers
6757	Filter Wheel, even numbers

LCM IV

The LCM IV is a reliable color instrument which replaces conventional visual color evaluation with an objective measurement. It is ideal for routine production control of clear, transparent liquids like resins, adhesives and solvents.

- Large 7" touch-screen display with intuitive user guidance for simple operation
- Automatic cuvette detection – avoids faulty data measurement
- Works with 10 and 50 mm rectangle as well as 11 mm round cuvettes for optimum precision
- Easy to exchange rectangular cell compartment
- Gardner, Hazen (APHA/PtCo), Iodine, Saybolt and Mineral oil scales come standard with instrument
- Reference beam design to maximize the accuracy and precision
- Front USB interface for PC or printer connection
- Easy data transfer into existing networks through integrated Ethernet (LAN) interface



Standards

ASTM	D 156, D 1045, D 1209, D 1544, D 1500
DIN	6162
ISO	4630, 6271, 2049

Technical Specifications

Voltage	100 - 240 V / 47 - 63 Hz
Type	Single-beam photometer with reference beam path
Spectral Range	380 to 720 nm, 10 nm resolution
Repeatability	± 2 Hazen ¹ , ± 0.1 Gardner ²
Reproducibility	± 0.3 Iodine ² , ± 5 Hazen ¹ , ± 0.3 Gardner ²
Light Source	Tungsten Halogen Lamp
Illuminant/Observer	C/2°
Indices	Hazen / APHA (0 to 1000), Gardner (0 to 18), Iodine (0 to 120), Saybolt (-16 to 30), Mineral Oil (ASTM D 1500) 0 to 8
Memory	400 color measurements
Data Export	*.csv file to USB memory stick or Ethernet
Interface	2x USB Typ A, 2x USB Typ B, 1x Ethernet (LAN)
Operating Temperature	10 - 40 °C (50 - 104 °F)
Humidity	up to 80%, 35 °C (95 °F); non condensing
Dimensions	151 x 350 x 255 mm (5.9 x 13.7 x 10 in)
Weight	4.2 kg (9.25 lbs)

¹ Based on data with 50 mm cuvette

² Based on data with 11 mm cuvette

Ordering Information

Cat. No.	Description
9561	LCM IV

Comes complete with:

Instrument with dust cover
 External power supply
 Adapter for 10 mm rectangle cuvettes
 addista® – color standards
 Disposable plastic cuvettes (10x50 mm) - pack of 10
 Disposable glass cuvettes (11mm) - pack of 10
 Operating manual



LCS IV

The LCS IV is a highly precise color instrument which spectrally measures all color shades of optically clear, transparent liquids using the dual beam principle. Besides the conventional visual color numbers (Gardner, Iodine, Hazen (APHA) etc.) the LCS IV can also measure opponent color systems such as CIE Lab, CIE LCh and Hunter Lab under the conditions of illuminant A, C, D65 and 2°/10° Standard Observer.

- Stand alone unit with built-in 7" touch-screen display allows use without the need of a PC
- All important color scales and indices included
- Automatic cuvette detection - avoids faulty data measurement
- Automatic zero and calibration memory for all type of cuvettes - ensures use of correct calibration data
- Designed for the use of disposable plastic cuvettes, high precision glass cuvettes or 11 mm test tubes
- Easy to exchange rectangular cell compartment
- High measurement reliability is guaranteed by comprehensive verification kits
- User profile memory with password protection for individual configurations - including GLP documentation
- Open sample compartment for ease of operation
- Front USB interface for PC or printer connection
- Easy data transfer into existing networks through integrated Ethernet (LAN) interface



Standards

AOCS	Method Cc 13e; Method BS 684 Iy/Lr
ASTM	D 156, D 848, D 1045, D 1209, D 1544, D 1925, D 1500, D 5368, E 308
DIN	5033, 6162, 6174
ISO	4630, 6271, 2049, 27608



Ordering Information

Cat. No.	Description
9562	LCS IV

Comes complete with:

Instrument with dust cover
 External power supply
 Adapter for 10 mm rectangle cuvettes
 addista® – color standards
 Disposable plastic cuvettes (10x50 mm) - pack of 10
 Disposable glass cuvettes (11mm) - pack of 10
 Operating manual

Technical Specifications

Voltage	100 - 240 V / 47 - 63 Hz
Geometry	0° / 180° rectilinear
Spectral Range (Colorimetric)	380 to 720 nm, 10 nm resolution
Spectral Range (Photometric)	320 to 1,100 nm, 1 nm resolution
Repeatability	0.1 ΔE*, 1 σ
Reproducibility¹	± 0.2% transmission
Light Source	Tungsten Halogen Lamp
Illuminant/Observer	A, C, D65 / 2°, 10°
Color Scale	CIE Lab; CIE LCh; Hunter Lab
Color Difference	ΔE* and component differences, text descriptor, tolerances
Indices	Gardner; Hazen/APHA; Iodine; Saybolt; Lovibond; Hess-Ives; European, US and Chinese Pharmacopoeia; Mineral oil; Yellowness; Acid Wash Test; Chlorophyll A; ADMI
Spectral Memory	% transmission; % absorbance, concentration 3000 color measurements, 100 color references, 1000 photometric readings
Data Export	*.csv file to USB memory stick or Ethernet
Interface	2x USB-A; 2x USB-B; 1x Ethernet (LAN)
Operating Temperature	10 - 40 °C (50 - 104 °F)
Humidity	up to 80%, 35 °C (95 °F); non condensing
Dimensions	151 x 350 x 255 mm (5.9 x 13.7 x 10 in)
Weight	4.2 kg (9.25 lbs)

¹ Referred to distilled water

Sample Cuvettes

For color measurement of liquids square, rectangle and cylindrical cuvettes can be used. Both precision as well as inexpensive disposable tubes are available. The precision cuvettes ensure reproducible results – even for critical solutions as clear as water. For daily QC disposable cuvettes save time and money.



Measurement Ranges for each Cuvette Size

Color Scale		Cuvette (mm)	Range
Iodine number	J	10, 11	0 to 120
(also LCM III)		50	0 to 7
Hazen number	H	10, 11, 50	0 to 1000
(also LCM III)			
Gardner number	G	10, 11	0 to 18
(also LCM III)		50	0 to 5
Transmission		10, 11, 50	0 to 150
Lovibond 5 1/4"	Y	10, 11	0 to 120
Lovibond 5 1/4"	R	50	0 to 12
Lovibond 1"	Y	10, 11	0 to 70
Lovibond 1"	R	50	0 to 12
Hess-Ives	H-I	10, 11, 50	0 to 500
Standard Tristimulus	XYZ	10, 11, 50	0 to 150
Chromaticity Coordinates	xy	10, 11, 50	0 to 1
CIE Lab values		10, 11, 50	
European Pharmacopoeia		10, 11, 50	Y1 to Y7 GY1 to GY7 BY1 to BY7 B1 to B9 R1 to R7



Ordering Information

Cat. No.	Description
6452	P-Glass Cuvette, 11 mm
9508	P-Glass Cuvette, 10 x 10
9509	P-Glass Cuvette, 10 x 50
6453	D-Glass Cuvette, 11 mm, open
9556	D-Glass Cuvette 11, screw top
9559	Rubber Stopper, 6453
9507	D-Plastic Cuvette, open
9555	D-Plastic Cuvette, plastic cover
9542	Rack 16, cylindrical - square
9560	Rack 7, rectangle

Technical Specifications

Pieces	Shape	Cover	Dimensions
25	cylindrical	rubber stopper	0.4 in (11 mm)
3	square	open top	0.4 x 0.4 in (10 x 10 mm)
1	rectangle	open top	0.4 x 1.9 in (10 x 50 mm)
500	cylindrical	open top	0.4 in (11 mm)
500	cylindrical	screw top	0.4 in (11 mm)
500	cylindrical	for Cat. No. 6453	0.4 in (11 mm)
50	rectangle	open top	0.4 x 1.9 in (10 x 50 mm)
10	rectangle	plastic cover	0.4 x 1.9 in (10 x 50 mm)
1	cylindrical and square		0.4 x 0.4 and 0.4 in (10 x 10 and 11 mm)
1	rectangle		0.4 x 1.9 in (10 x 50 mm)

Accessories

addista® – color Standards

To meet the requirements of ISO 9000 the performance of the instrument should be tested periodically. Therefore, a certified set of 6 standard liquids is recommended, containing Gardner and Hazen color numbers. To ensure long-term stability, the bottles should be stored in a dark and cool environment. They expire three months after being opened.



Ordering Information

Cat. No.	Description
9532	addista® - color standards



Verification Kit

For more detailed quality control of the instrument a Verification Kit is available which consists of four precision glass filters. The filters come with a certificate including target values and can be used to check for stray light, photometric and wavelength accuracy. When results exceed allowable tolerance, please contact your local service office.

Ordering Information

Cat. No.	Description
9575	Verification Kit, LCS III - IV
9582	Verification Kit, LCM III - IV



Power Supply

Both the LCM/LCS III and LCM/LCS IV are powered by an external power supply. Additionally, the LCM III can be used as a truly portable device with the optional rechargeable lithiumion battery. The external power supply acts as the charger.



Ordering Information

Cat. No.	Description
9581	Li-Ion Battery , LCM III
9577	Power Supply, LCM/LCS III

Tungsten Halogen Lamp

The LCM/LCS III and LCM/LCS IV use a tungsten lamp with an expected lifetime of 2000 hours. It can easily be replaced by the user.

Ordering Information

Cat. No.	Description
9576	Halogen Lamp, LCM/LCS III - IV



Thermostat Heater Block

Highly viscous liquids should be preheated in the heater block. The temperature can be set from 37 °C to 148 °C (99°F to 298°F). Only cylindrical tubes can be used. The illuminated LC display ensures easy-to-read results and operator guidance.



Ordering Information

Cat. No.	Description
9511	Thermostat Heater Block



Portable Printer

The portable thermo printer allows documentation of measurement results.



Ordering Information

Cat. No.	Description
9563	Thermo Printer, 115 V
9564	Thermo Printer, 230 V

Air Filter Pad

The LCS III is equipped with an air filter to cool the instrument during operation. The pad should be inspected regularly every 3 months. Typically it needs to be replaced 1 - 2 times per year.

Ordering Information

Cat. No.	Description
9573	Air Filter Pad for LCS III

***Note:** Not needed for LCM III and LCM/LCS IV





Consistent Quality of Cosmetic Products

Can you imagine the world of cosmetics without color, gloss or glitter? By adding metallic or interference pigments to cosmetic formulations fascinating effects can be achieved. In order to guarantee consistency, a routine quality control system needs to be established. Key component is one binding reference with realistic tolerances to control batch to batch variations. In order to obtain repeatable results, standardized sample preparation is crucial.

Powders, pastes and liquids can either be measured in mass or in case of lower viscosity products as drawdowns on test charts. In both cases, all non-drying or powdery products require a non-contact measurement technique to protect the instrument's optic. Compared with the measurement through glass or film, non-contact will be the preferred method since this technique correlates best with how the consumer perceives the final product in the store.

Measurement of powders

Powdery eye shadow and facial powder are pressed in "shape". For production quality control a standardized technique needs to be established to always maintain the same plunger pressure as well as the same plunger tissue. A smooth and non-textured surface allows an objective measurement of the color hue and the sparkling behavior of effect pigments. A sample holder with disposable round dishes was especially designed for the measurement of pressed powders. The loose powder is filled

and pressed based on a standardized technique into the disposable dish. A special powder holder is available with different instrument masks to allow objective color and gloss measurement. The instrument mask is custom made to fit the aperture of the respective instrument guaranteeing repeatable sample placement and measurement results as well as non-contact measurement to protect the instrument's optic (see page 118).

Measurement of liquid foundations

Foundations often have a low to medium viscosity and therefore, can either be measured in mass or as a drawdown on a test chart. Applying the foundation on a black and white chart can give additional information on hiding power (opacity). For this purpose a special wet drawdown template was developed for placing the color or gloss instrument onto the wet drawdown without contact. For ease of handling the template is made of easy-to-clean hard-anodized aluminum (see page 117).

Measurement of lipstick

The difficulty in measuring the color and gloss of a lipstick is the high curvature and the pasty material. Therefore, a special sample holder was developed, which holds the lipstick in its tube in place and the color instrument can be placed on a sample stand with a mask to ensure non-contact measurement. The holder is sealed with a light barrier to guarantee repeatable measurement results (see page 116).

Introduction

Together with color measuring instruments, light booths are key components for effective color control. Especially when parts of different materials or surface texture need to harmonize, the human eye is often the final judge for approving a new design. Therefore, the visual inspection conditions need to be standardized to guarantee repeatable visual results.

Visual Color Evaluation

Color perception is dependent on personal experience as well as illumination and observing conditions. As the ambient conditions are highly variable and not consistent at all, it is required to simulate different common lighting situations. Additionally, these should be easily switchable to recognize and avoid so-called "Metamerism", i.e. differences in color matching when lighting conditions change. In order to guarantee comparable testing and evaluation conditions, international standards specify testing procedures defining the following components:

Observer

The observer conducting the visual appraisal must have normal color vision and should be trained in observing colors. To avoid eye fatigue the color decision has to be performed within seconds and small breaks are to be taken between evaluations. As people describe color differently, the following order should be used for communication and documentation of color: first hue, second chroma and third lightness.

Object

The samples and standards should be prepared with a specified method; be flat and have uniform color, gloss and surface texture. The specimen shall be placed in the same plane as the standard; both should be in close contact and be reversed from time to time. The preferred size of the samples is approximately 10 by 15 cm. The viewing distance between eyes and specimen should be 50 cm, which corresponds to the 10° standard observer.

Surrounding

For color appraisal the visual field immediately next to the product as well as the ambient visual field, when the observer glances away to let his eyes rest, are of high importance. In practice, this means to use a light booth or viewing room with matte light gray interior surfaces and the appraiser should wear neutral colored clothing to avoid disturbing chromatic reflections.

While solid colors ask for diffusely distributed light, metallics and other effect colors require directed light to see the influence of flake orientation.

LIGHT BOOTHS



Light Source versus Standard Illuminant

Color impression is highly dependent on the spectral distribution of the ambient light. The same good matching under an artificial light source in a department store can mismatch under natural daylight. For reliable color evaluation, CIE defined so-called standard illuminants.

Daylight Illuminants

The main illuminant is always daylight. As natural daylight varies in color and intensity over time, CIE defined the standard illuminant D65, which describes an average daylight with a color temperature of 6500 K. Other daylight illuminants recommended by CIE are D75 describing overcast north-sky daylight, D50 common for applications in graphic arts and C, which is an outdated illuminant of average north-sky daylight.

These illuminants are a theoretical representation for daylight with defined spectral power distributions. The challenge is to simulate these using artificial light sources, because there are no lamps available, which fulfill exactly the defined CIE standard illuminants. The closer a lamp meets the CIE specification, the better is the accuracy of visual color matches.

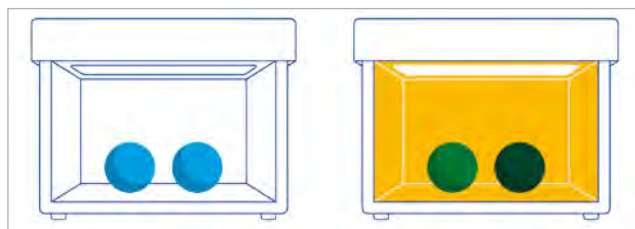
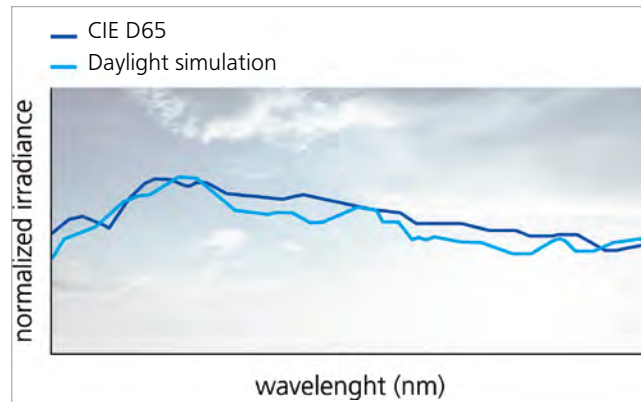

Standard Illumination D65 (CIE)

Light bulb A (CIE)

Metamerism

Visual appraisal is particularly important for multi-component products consisting of different materials or parts with different pigment formulations, which can cause different spectral curves. In these cases, a match under one light source might not ensure a match under another one. To test this phenomenon called metamerism, the specimens are usually compared under daylight and at least one other light source, depending on the final sales or enduse application. Therefore, CIE defined additional illuminants: Standard illuminant A, which describes tungsten lamps, as well as a variety of fluorescent illuminants e.g. F2 or F11, which represent common fluorescent tubes used in department stores.

Simulation of Natural Daylight

As D65 is the most commonly used illuminant, the artificial light sources should offer an as close as possible simulation. CIE Publication 51.2 describes a method to rate the quality of daylight sources. The method uses metameric sample pairs with a meta-merism index (MI) for standard illuminant D65 of MI=0. The bigger the MI-value is the worse is the simulation quality. Class A with a low MI-value provides the best daylight simulation, while class E with very high MI = 2 indicates a very poor simulation. For critical color evaluation, ASTM D 1729 recommends in the visual range (M_{vis}) class B or better. The byko-spectra *pro* offers the highest M_{vis} class A for daylight simulation of CIE D65 and D75 utilizing filtered tungsten halogen lamps combined with LEDs.

BYK-Gardner offers a complete line of standardized light cabinets: Light booths in various sizes and at different price levels dependent on your final application and accuracy needed.

Light Booth	Viewing Area	Application	Illuminants	Daylight Source
byko-spectra <i>effect</i>	32 x 60 cm (sample table)	Multi-angle Color Sparkle	1 3 LEDs	Fluorescent tube
byko-spectra <i>pro</i>	56 x 89 x 60 cm	Solid Color	8	Filtered halogen lamps with LEDs
byko-spectra <i>lum</i>	89 x 60 cm (luminaire)	Solid Color	5	Fluorescent tubes
byko-spectra <i>standard</i>	48 x 71 x 51 cm	Solid Color	5	Fluorescent tubes
byko-spectra <i>lite</i>	36 x 61 x 41 cm	Solid Color	3	Fluorescent tubes
byko-spectra <i>basic</i>	37 x 60 x 33 cm	Solid Color	3	Fluorescent tubes
byko-spectra <i>mini</i>	33 x 46 x 25 cm	Solid Color	3	Fluorescent tubes

byko-spectra *effect*

Visual Evaluation of Effect Finishes

Metallic and effect finishes are getting more and more popular in many applications like automotive, appliances, furniture or architectural elements to emphasize the design and make the color "alive". In contrast to solid colors, effect finishes change their color and appearance with viewing angle and lighting conditions. Metallic and interference pigments will not only change their lightness and color, but also their sparkling effect will be different when lighting conditions change from sunlight to cloudy sky.

To perform a standardized visual evaluation of metallic and effect finishes correlating to instrumental results of multi-angle spectrophotometers, like BYK-mac i, different viewing angles and viewing conditions are necessary:

- Lightness flop and color travel:
45° illumination under daylight illuminant and 6 viewing angles: -15°/15°/25°/45°/75°/110°.
- Sparkling effect: Direct illumination under three angles
15°/45°/75° using bright LEDs and direct viewing.

To enhance the direct illumination a black surrounding is important.

Total Color Impression with Defined Light

With BYK-Gardner's byko-spectra *effect* light booth, it is now possible to set all these parameters and ensure visual evaluation under standardized conditions, which achieve the best agreement with instrumental evaluation.

- The high-quality daylight sources ensure quick and reliable color and effect judgement, without warm-up time or flickering.
- To simulate flake impression under direct sunlight bright white LEDs are used for illumination. Lifetime of the LED light sources is guaranteed for 10 years.
- The LEDs can be dimmed to adjust the lightness depending on sample type or user needs.



Helpful Functions – Easy Operation

- Time tracker indicates how long the lamps are in operation and you exactly know when a replacement is necessary.
- A tiltable sample table allows the samples to be precisely evaluated at the six defined angles. The illumination system pivots together with the sample table.

Info!

For information on objective measurements of effect finishes see BYK-mac i.



Ordering Information

Cat. No.	Description
6027	byko-spectra <i>effect</i>

Comes complete with:

byko-spectra *effect* light booth
Operating instructions

Technical Specifications

Voltage	115 / 230 V, 50 / 60 Hz
Dimensions Light Booth	121 x 80 x 76 cm (47.7 x 31.7 x 29.9 in)
Dimensions Sample Table	32 x 60 cm (12.6 x 23.6 in)
Weight	58,8 kg (127.2 lbs)



Ordering Information

Cat. No.	Description
6026	Daylight Tube, byko-spectra <i>effect</i>

Accessories

Replacement is recommended after 750 hours

byko-spectra *pro*

Best in Class Daylight

It is a real challenge to achieve the standard daylight D65 or D75 as defined by CIE. The new byko-spectra *pro* uses a smart combination of filtered tungsten-halogen lamps and LEDs. That makes the highest rendering Class A according CIE 51.2 available and guarantees accurate color matching.

Light for any Application and Specification

In total eight certified illuminants make you prepared to precisely ensure, that your goods will pass under all common lighting conditions without any metamerism:

- Daylight D65, D75
- Incandescent light A
- 2300 K/Horizon HZ
- Department store light CWF, TL84, U30
- Ultra-violet light UV

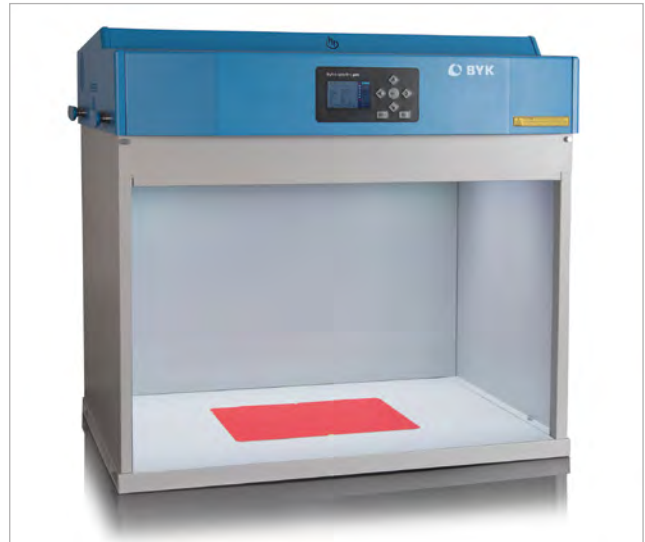

100% Controlled Illumination ensures Accurate Color Evaluation

Long lasting, reliable lighting conditions are the prerequisite for credible color appraisals. The built-in sensors of byko-spectra *pro* permanently control the lamp performance and automatically adjust the voltage to guarantee lamp stability. Actual color temperature and light intensity in lux are detected by a light monitoring system and simultaneously shown on the display.

A special highlight is the extended lifetime of the halogen lamps reducing the maintenance interval. Additionally, a time tracker indicates how long the lamps are in operation and you exactly know when a replacement is necessary. As diffused light is necessary to evaluate solid colors, diffusers mix the light to ensure uniform lighting over the entire inspection field.



Comfortable Functions for Efficient Operation

The large color display allows not only switching between the illuminants, but also enables easy menu guided operation.

- Adjust the lux output of fluorescent tubes based on sample type or user needs – optimum viewing for light and dark colors.
- Auto sequence mode enables automatic switching between multiple illuminants – you will fully focus on color appraisal. Predefine the sequence to your individual needs:
 - Selection of illuminants
 - Duration time
 - Intensity of fluorescent tubes
 - Single run or repeat
- The remote control allows easy switching between illuminants from a distance of up to 10 m.

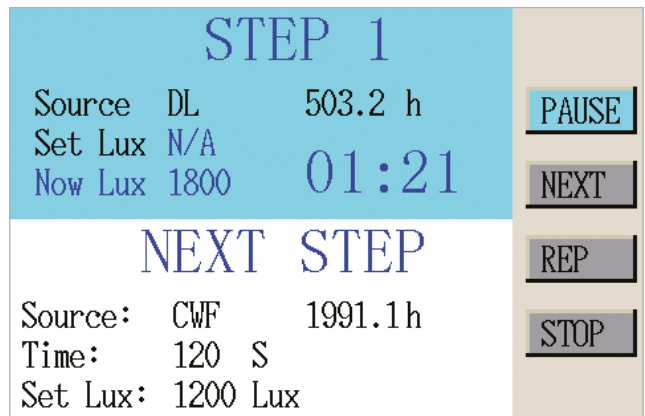

Light-up in Harmony

The luminaires, byko-spectra *lum*, are available for mounting on the ceiling or a wall to conveniently appraise large products.

- 2 to 32: Several luminaires are combined in a modular system to illuminate large appraisal fields or to equip harmony rooms.
- One: All luminaires are operated together via the same control panel.
- Eight: The system can be split in up to eight groups and be controlled separately.

The luminaires and harmony rooms offer the same illumination as the byko-spectra *pro* light booths.

We assist you in the design and set-up of your customized color inspection system, best fitting to your products and appraisal environment. Additionally we offer on-site audits to assure the appraisal conditions meet the required specifications.

Our maintenance programs support you to keep always consistent and accurate viewing conditions.

Standards

ASTM	D 1729
ISO	3668 (accessory required)



Ordering Information

Cat. No.	Description
6073	byko-spectra <i>pro</i> 230 V
6072	byko-spectra <i>pro</i> 115 V
6075	byko-spectra <i>lum</i> 230 V
6074	byko-spectra <i>lum</i> 115 V

Technical Specifications

Voltage	Display	Dimensions	Viewing Area	Weight
230 V, 50/60 Hz	8,3 x 5,5 cm (3.3 x 2.2 in)	70 x 99 x 64 cm (27.5 x 39 x 25 in)	56 x 89 x 60 cm (22 x 35 x 23.5 in)	49 kg (108 lbs)
115 V, 50/60 Hz	8,3 x 5,5 cm (3.3 x 2.2 in)	70 x 99 x 64 cm (27.5 x 39 x 25 in)	56 x 89 x 60 cm (22 x 35 x 23.5 in)	49 kg (108 lbs)
230 V, 50/60 Hz	8,3 x 5,5 cm (3.3 x 2.2 in)	21 x 99 x 64 cm (8.3 x 39 x 25 in)	89 x 60 cm (35 x 23.5 in)	40 kg (88 lbs)
115 V, 50/60 Hz	8,3 x 5,5 cm (3.3 x 2.2 in)	21 x 99 x 64 cm (8.3 x 39 x 25 in)	89 x 60 cm (35 x 23.5 in)	40 kg (88 lbs)

Comes complete with:

Light booth (6072-6073) or
Luminaire (6074-6075)
8 illuminants: D65, D75, A, HZ, CWF, TL84, U30, UV
25% Attenuator (2 pcs) for D75
Remote control with 2 x AAA batteries
System report software for download
USB cable
Power Cord
Snap hook (4 pcs)
Cascade cable
Backup fuse (4 pcs)
Operating manual
Factory certificate



Ordering Information

Cat. No.	Description
6076	D65 Halogen Lamp for 6072-6075
6077	A Lamp for 6072-6075
6078	HZ Lamp for 6072-6075
6079	CWF Lamp for 6072-6075
6080	TL84 Lamp for 6072-6075
6081	U30 Lamp for 6072-6075
6082	UV Lamp for 6072-6075
6083	LED Array, left for 6072-6075
6084	LED Array, right for 6072-6075
6085	ISO Panel Set for 6072-6075
6086	Remote control for 6072-6075
6087	25% Attenuator D75
6337	USB Interface Cable

Technical Specifications

Voltage	Lamp Lifetime
230 / 115 V	600 hrs
230 / 115 V	600 hrs
230 / 115 V	600 hrs
230 / 115 V	2000 hrs
230 / 115 V	2000 hrs
230 / 115 V	2000 hrs
230 / 115 V	2000 hrs
230 / 115 V	700 hrs
230 / 115 V	700 hrs

Five Controlled Illuminants

Critical Solid Color Evaluation

For accurate color appraisal, the byko-spectra light booths with 5 illuminants offer all you need to evaluate and communicate color with confidence.

- | | |
|--------------------------|--------------|
| ■ Daylight | D65 |
| ■ Incandescent light | A |
| ■ Department store light | CWF and TL84 |
| ■ Ultra-violet light | UV |

Comfortable Handling

Automatic illuminant sequencing allows a standardization of your testing procedures and focus on color matching. The illuminant sequence and duration time can be predefined.

The replacement lamp kits reduce the maintenance effort to a minimum.

Recognize metamerism

Evaluating your sample pairs under different illuminants helps you to indicate metameric samples and minimize product rejection or rework.

Detect fluorescent pigments

Viewing under ultraviolet light allows detecting and evaluation of optical brighteners or fluorescent pigments.

Surrounding for any specification

Consistent color-neutral environment enables comparison of standard and sample at standardized conditions.

Standards

ASTM	D 1729
ISO	3668 (accessory required)

Certified

Please refer to section Preventive Maintenance

byko-spectra *standard*

Versatile functions ensure an easy and reliable inspection of large and small samples.

- Diffusing panel to eliminate direct reflection
- ColorGuard II timing center tracks light source usage and indicates when to replace the lamps
- No warm-up time or flickering which ensures quick and reliable color judgement

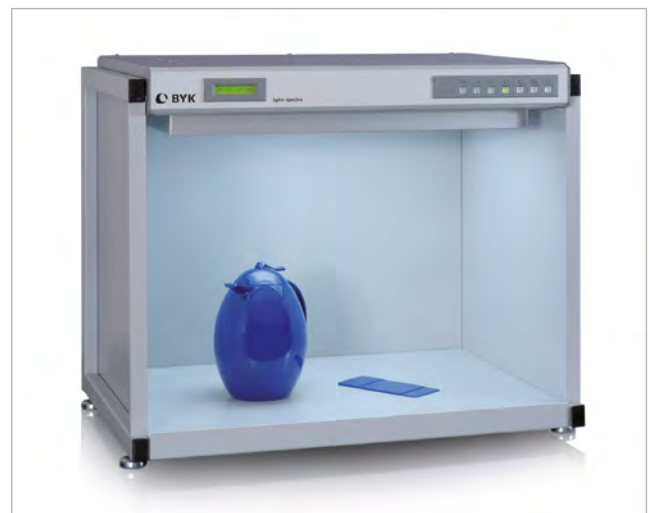

byko-spectra *lite*

This economic light booth ensures easy testing and inspection under standardized illuminations for any application.

- Timer to track daylight lamp usage and indicate when to replace the tubes
- Quick light booth setup without any tools
- Comfortable evaluation combined with ease-of-use



Ordering Information

Cat. No.	Description
6047	byko-spectra <i>standard</i> 230 V
6046	byko-spectra <i>standard</i> 115 V
6061	byko-spectra <i>lite</i> 230 V
6060	byko-spectra <i>lite</i> 115 V

Comes complete with:

Light booth
5 illuminants: D65, A, CWF, TL84, UV
Factory certificate
Operating instructions

Technical Specifications

Voltage	Dimensions	Viewing Area	Weight
230 V, 50/60 Hz	65 x 76 x 55 cm (25.5 x 30 x 21.5 in)	48 x 71 x 51 cm (19 x 28 x 20 in)	32 kg (70 lbs)
115 V, 50/60 Hz	65 x 76 x 55 cm (25.5 x 30 x 21.5 in)	48 x 71 x 51 cm (19 x 28 x 20 in)	32 kg (70 lbs)
230 V, 50/60 Hz	49 x 67 x 48 cm (19.5 x 26 x 19 in)	36 x 61 x 41 cm (14 x 24 x 16 in)	18 kg (39 lbs)
115 V, 50/60 Hz	49 x 67 x 48 cm (19.5 x 26 x 19 in)	36 x 61 x 41 cm (14 x 24 x 16 in)	18 kg (39 lbs)



Ordering Information

Cat. No.	Description
6048	Lamp Kit, certified for 6046/6047
6065	Lamp Kit for 6046/6047
6057	ISO Panel Set for 6046/6047
6063	Lamp Kit, certified for 6060/6061
6062	Lamp Kit for 6060/6061
6064	ISO Panel Set for 6060/6061

Accessories

Voltage	D65	Inc A	CWF	TL84	UV
230 / 115 V	3	2	2	2	2
230 / 115 V	3	2	2	2	2
230 / 115 V	2	2	2	2	2
230 / 115 V	2	2	2	2	2

Note: Replacement of lamps recommended every 2500 hours.

Three Controlled Illuminants

Reduce the Risk of Metamerism

For general solid color evaluation under defined lighting conditions the byko-spectra *basic* and byko-spectra *mini* light booths offer three certified illuminants:

- Daylight D65
- Incandescent light A
- Department store light CWF or TL84

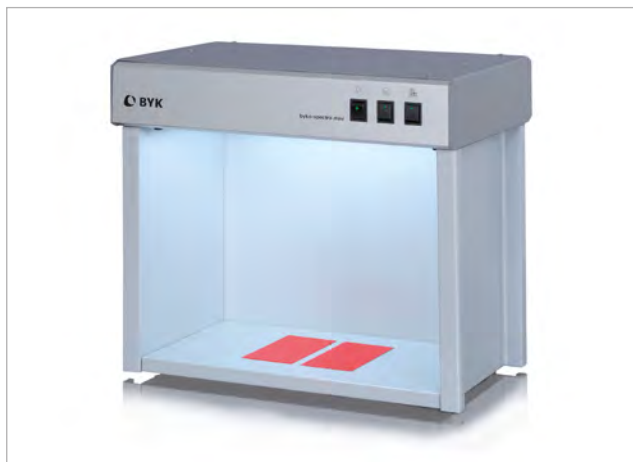

Fast Setup - Easy Operation

The light booths are assembled in minutes without any tools. Individual switches for each illuminant guarantee an easy operation.

Economical Testing of Small Samples

The compact design allows color check everywhere. The small byko-spectra *mini* even fits on small desk spaces.



Ordering Information

Cat. No.	Description	Technical Specifications			
		Voltage	Dimensions	Viewing Area	Weight
6054	byko-spectra <i>basic</i> , TL84, 230 V	230 V, 50/60 Hz	48 x 67 x 42 cm (19 x 26.5 x 16.5 in)	37 x 60 x 33 cm (15 x 24 x 13 in)	14 kg (30 lbs)
6052	byko-spectra <i>basic</i> , CWF, 230 V	230 V, 50/60 Hz	48 x 67 x 42 cm (19 x 26.5 x 16.5 in)	37 x 60 x 33 cm (15 x 24 x 13 in)	14 kg (30 lbs)
6051	byko-spectra <i>basic</i> , CWF, 115 V	115 V, 50/60 Hz	48 x 67 x 42 cm (19 x 26.5 x 16.5 in)	37 x 60 x 33 cm (15 x 24 x 13 in)	14 kg (30 lbs)
6053	byko-spectra <i>basic</i> , TL84, 115 V	115 V, 50/60 Hz	48 x 67 x 42 cm (19 x 26.5 x 16.5 in)	37 x 60 x 33 cm (15 x 24 x 13 in)	14 kg (30 lbs)
6043	byko-spectra <i>mini</i> , TL84, 230 V	230 V, 50/60 Hz	46 x 52 x 34 cm (18 x 20.5 x 13.25 in)	33 x 46 x 25 cm (13 x 18 x 10 in)	10 kg (22 lbs)
6041	byko-spectra <i>mini</i> , CWF, 230 V	230 V, 50/60 Hz	46 x 52 x 34 cm (18 x 20.5 x 13.25 in)	33 x 46 x 25 cm (13 x 18 x 10 in)	10 kg (22 lbs)
6040	byko-spectra <i>mini</i> , CWF, 115 V	115 V, 50/60 Hz	46 x 52 x 34 cm (18 x 20.5 x 13.25 in)	33 x 46 x 25 cm (13 x 18 x 10 in)	10 kg (22 lbs)
6042	byko-spectra <i>mini</i> , TL84, 115 V	115 V, 50/60 Hz	46 x 52 x 34 cm (18 x 20.5 x 13.25 in)	33 x 46 x 25 cm (13 x 18 x 10 in)	10 kg (22 lbs)

Comes complete with:

Light booth
3 illuminants: D65, A, CWF or TL84
Factory certificate
Operating instructions

Standards

ASTM	D 1729
ISO	3668 (accessory required)



Ordering Information

Cat. No.	Description	Accessories				
		Voltage	D65	Inc A	CWF	TL84
6055	Lamp Kit for 6051/6052	230 / 115 V	2	2	1	
6056	Lamp Kit for 6053/6054	230 / 115 V	2	2		1
6070	Lamp Kit, certified for 6051/6052	230 / 115 V	2	2	1	
6071	Lamp Kit, certified for 6053/6054	230 / 115 V	2	2		1
6058	ISO Panel Set for 6051 - 6054					
6045	Lamp Kit for 6043	230 V	2	2		1
6044	Lamp Kit for 6041	230 V	2	2	1	
6050	Lamp Kit for 6042	115 V	2	2		1
6049	Lamp Kit for 6040	115 V	2	2	1	
6067	Lamp Kit, certified for 6043	230 V	2	2		1
6066	Lamp Kit, certified for 6041	230 V	2	2	1	
6069	Lamp Kit, certified for 6042	115 V	2	2		1
6068	Lamp Kit, certified for 6040	115 V	2	2	1	
6059	ISO Panel Set for 6040 - 6043					

Note: Replacement of lamps recommended every 2500 hours.



Harmony of Consumer Electronics

Design knows no limits. This is also reflected in the world of consumer electronics such as notebooks, tablets, smartphones, cameras, TVs or home appliances in general. Smartphones have become our permanent companions; their look including design and color is most important and follows current fashion trends! Depending on the preferences of specific target groups manufacturers offer a variety of colors with glossy or matte surface finishes which need to be controlled.

Color measurement of solid colors

Neutral colors only tolerate very small color deviations and require very tight tolerances. A high chromatic color will accept larger tolerances dependent on its hue. Vacuum cleaners for example are produced in high chromatic solid colors with a high gloss finish. The spectro-guide is the ideal solution as it measures color and gloss simultaneously. Thus, the cause of a mismatch can be clearly identified.

Color measurement of effect colors

In contrast to solid colors, products with effect finishes change their appearance with viewing angle and lighting conditions. This is a special challenge on parts with very tight fits. For example on notebooks, the track pad and the surrounding housing should have the same color and appearance even though both parts are made of completely different materials. In the following example lightness as well as sparkle considerably vary between the reference and the two samples. For small parts the BYK-mac i with a 12 mm aperture can be used together with a specially designed sample holder.

Gloss measurement

The control of gloss is as important as the color matching. If one component has a different gloss level than the rest, the consumer will immediately recognize it. Gloss of plastic parts is highly dependent on the mold condition and variation of process parameters such as mold temperature, injection rate or material variations. Depending on the product specifications the accepted gloss variations can be as small as +/- 0.5 gloss units. Objective measurement results that are repeatable and temperature independent are most important in harsh mass production processes. The micro-gloss has been the unsurpassed industry standard guaranteeing accurate and reliable readings under any circumstances.

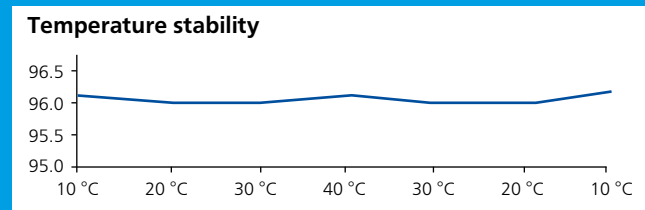
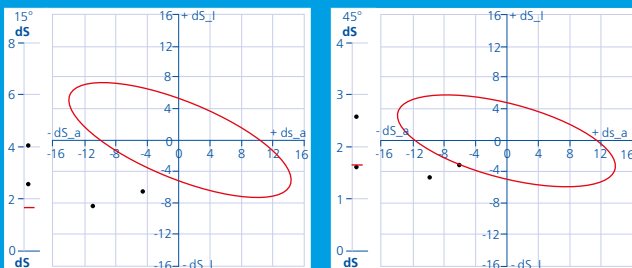
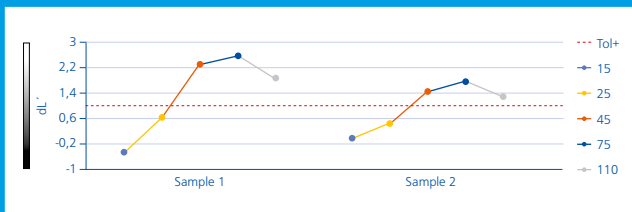

The micro-gloss gives the same measurement results between 10 °C–40 °C. No calibration or time for adjustment needed.



Touch the color with our new spectro2guide:

There it is in black and white: The new spectro2guide has arrived. The revolution in color management.



Upfront design. Color touchscreen. Camera preview. Auto calibration. Gloss. Fluorescence. Digital standard...

www.touchthecolor.com

Appearance

Color

Physical Properties

Technical Service

Index

PHYSICAL PROPERTIES

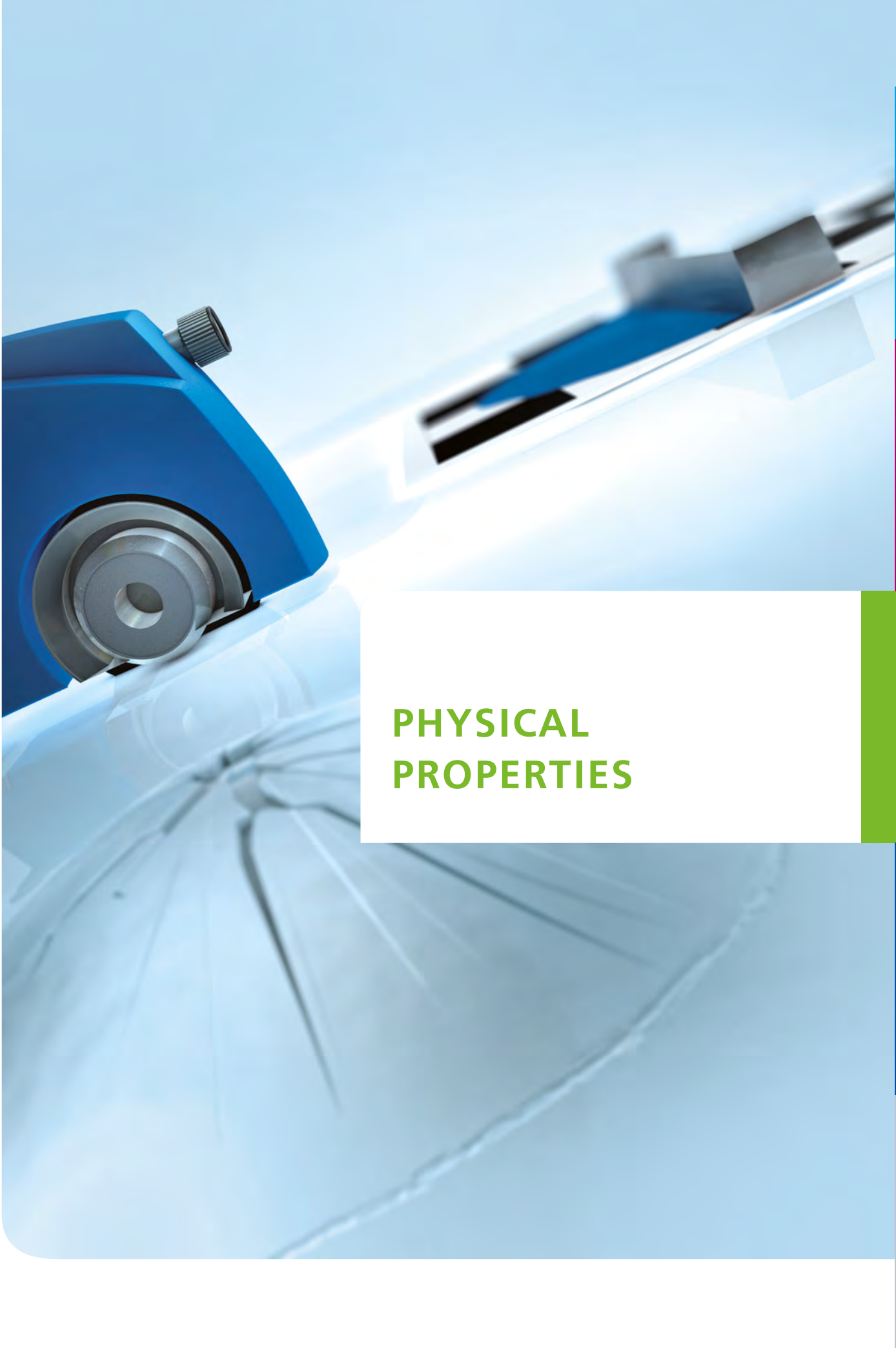

PHYSICAL PROPERTIES

New! Abrasion	149
Adhesion	157
New! Application	167
Balances	193
Conductivity	199
Density	200
Dispersion / Grind gages	202
Drying Time	204
Film Thickness	207
Hardness	221
Impact / Flexibility	227
Microscopes	243
Surface Tension	247
New! Temperature	249
Viscosity	265

Gardner-scrub ECE 43

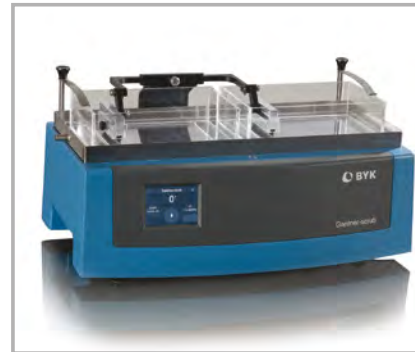

byko-drive XL

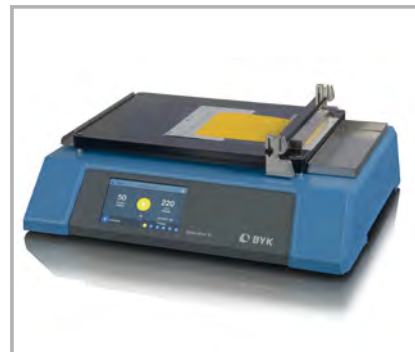

temp-gard basic

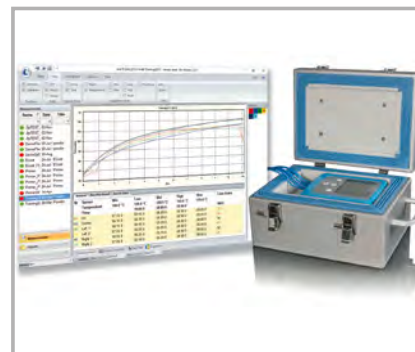

Introduction

Abrasion

Coated and uncoated surfaces need to be tested for resistance to abrasion caused by a brush, sponge, scouring pad, sand paper, and other means. Abrasion Scrub Testers are also used to test the washability of coatings and other surfaces. International specifications describe various testing procedures for specific application:

DIN ISO Methods

The Standards EN ISO 11998 and DIN EN 13300 (replaced DIN 53778) describe procedures to evaluate the resistance of coatings against wet abrasion by cleaning or scrubbing the surface. The coating is applied on a foil and dried under standard conditions. In order to describe the cleanability, defined pollutions are applied onto the surface before starting the test.

DIN 53 778 (*withdrawn 08/2007): Dispersion Paints Cleanability: Test area should be free of pollutions. Wash resistance: Evaluation after 1000 scrub cycles Scrub resistance: Evaluation after 5000 scrub cycles. The test is performed wet using a hog bristle brush and a pump to apply the washing liquid. The evaluation is done visually.

ISO 11998 The ISO test method describes a short version of the wet scrub abrasion test. This test uses "3M Scotch Brite 7448" pads and the washing liquid is manually applied before starting the test. The test is finished for evaluation after 200 scrub-cycles. The evaluation of the wash/scrub resistance is done by calculating the loss of mass.

DIN EN 13300 This standard describes the classification for waterborne coating materials and coating systems for interior walls and ceilings. One quality criterion mentioned is the wet-abrasion resistance tested in accordance to EN ISO 11998. Additionally, a rating scale dependent on the amount of abrasion is used for final classification.



ABRASION



ASTM Methods

The Wet Abrasion Scrub Tester is designed to comply with several ASTM methods.

ASTM D 2486 The scrub resistance of interior wall paint is the primary purpose of this method. The paint is applied to a black plastic panel and allowed to cure. The panel is scrubbed with a nylon bristle brush until failure occurs. An abrasive scrub media is used to accelerate the test.

ASTM D 3450 This test method determines the ease of removing soilant discoloration from interior coatings. The coating is drawn-down on a black plastic panel and allowed to dry for seven days. A specified soilant medium is applied. The coating is scrubbed with an abrasive or non-abrasive media using a cellulosic type sponge for 100 cycles. The soilant removal is assessed by measuring the CIE Y standard tristimulus value before and after the test.

ASTM D 4213 The purpose of this method is to measure scrub resistance. The primary differences from ASTM D 2486 method are: The scrub resistance is determined by weight loss of the paint film relative to a standard calibration panel. The test panel and calibration panel are scrubbed simultaneously. The scrubbing device is a Scotch-Brite™7448 abrasive pad.

ASTM D 4828 This test method determines the relative ease of removing soil and stains from interior coatings. The coating is applied to a black plastic panel and dried for seven days. The soilant can be user defined or the soilant described in ASTM D 3450 can also be used. A user defined liquid or powder cleaner is applied. The panel is scrubbed 100 cycles with a sponge. The soilant removal is assessed using gloss or color measurement.

ECE 43 Wiper Resistance test

In specific applications is necessary to adapt a test method to the typical stresses during its real-world use. The wiper resistance test was developed to simulate accelerated abrasion by automotive windshield wipers under controlled laboratory conditions. Instead of rotating abrasive wheels, a linear back and forth motion of a wiper blade is applied to the sample under test. The test specimen is placed in a box filled with a defined suspension according to ISO 12-103-1 A4 at ambient temperature.

Standards

ASTM	D1792, D2198, D2486, D3206, D3207, D3450, D4213, D4488, D4828, D6736
ISO	11998
DIN EN	53778, 13300
Canadian Government Specification	26-GP-3a
Commonwealth of Pennsylvania Specification	
US Federal Specification	P-C-431a, P-D-220A, P-R-201b, P-W-155, T-1279D, TT-P-18, TT-P-22, TT-P-23a, TT-P-26a, TT-P-29B, TT-P-30, TT-P-47a, TT-P-51d, TT-P-88a, TT-P-508
FTMS	141A, 6141, 6142
US Military Specification	MIL-C-3004, MIL-C-46057, MIL-E-11237, MIL-P-13340A, MIL-P-15422B
US Navy Specification	512C20C
Rock Island Arsenal Specification	RIX-268
Master Painter Institute	MPI 138
Economic Council Europe	ECE 43

Gardner-scrub

Abrasion Scrub and Washability Tester

Coated and uncoated surfaces need to be tested for resistance to abrasion caused by a brush, sponge, scouring pad, sand paper, and other means. Abrasion resistance can be tested by wet abrasion methods using scrub media or cleaning solutions. The most common applications are testing the scrub resistance of interior wall paints, floor tiles, shower stalls, and furniture surfaces. The abrasion tester can examine the washability of a coated surface for the removal of stains. Detergents and cleaning solutions can be tested and evaluated in a reproducible manner.

Gardner-scrub Abrasion Tester

The Gardner-scrub abrasion tester offers a versatile design for abrasion and washability testing applications. The instrument arm is designed to hold from 1 - 3 brush holders or ISO pad holders. A large selection of accessories are available to customize your test requirements. An intuitive touch screen operation makes it easy to change test parameters. The Gardner-scrub has a durable chain drive mechanism for long-term reliable operation.

- Reciprocating linear motion with a constant speed over the travel distance for repeatable results
- Compact design saves on counter space
- Easy to use touch screen display
- Instrument arm holds up to 3 brush or pad holders to increase output
- User selectable scrub rate from 6 - 60 cycle/minute
- Compliant with ASTM, DIN, and ISO methods with appropriate accessories
- Up to 4 kg (8.8 lbs) can be applied to the instrument arm
- Adjustable stroke length 22.9 - 27.9 cm (9 - 11 in.)
- Optional weights for custom applications

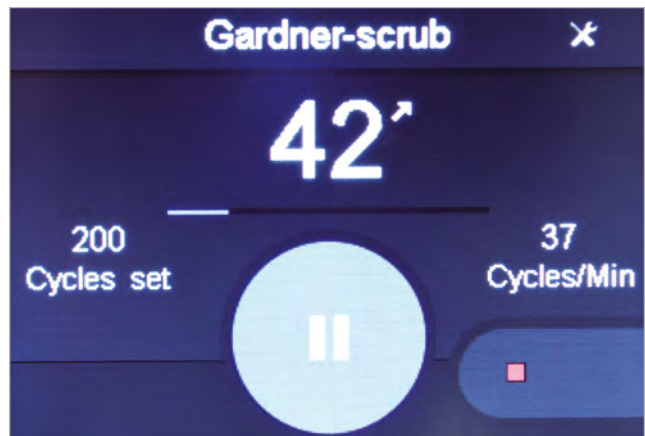

Gardner-scrub touchscreen display

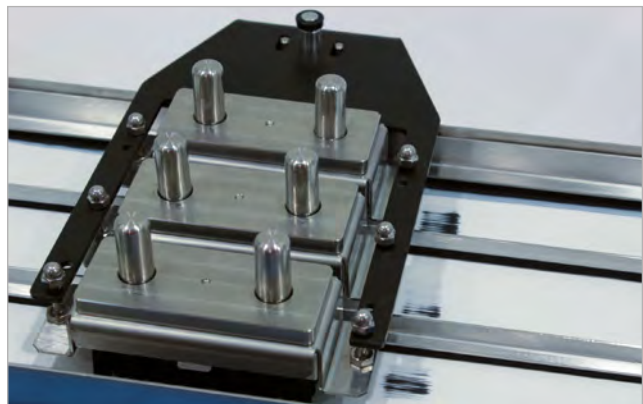

Gardner-scrub three brush configuration with Lilly Frame

Gardner-scrub



Ordering Information

Cat. No.	Description
5060	Gardner-scrub, base
5061	Gardner-scrub, ASTM D2486
5062	Gardner-scrub, DIN 53778
5063	Gardner-scrub, ISO 11998
5097	Gardner-scrub, ECE 43

***Note:**

For two or three brush or pad holder operation additional brush holders and pad holders must be ordered as accessory items.

Technical Specifications

Comes with	Instrument, Sample pan (5041), Scrub panels (5015) Power supply, Manual Base model (5060), 1-Brush holder w/mat (5074), Nylon brush (5011), Lilly frame (5038), Brass shim (6979), Glass plate (6980), Scrub panels (5015) Base model (5060), 1-Brush holder w/mat (5075), Hog Brush (5010), Liquid metering system (5037), Glass plate (6980), Scrub panels (5015) Base model (5060), 1-Pad holder (5076), Scotch brite pads (5012), 1-ISO Arm adapter (5059), Glass plate (6980), Scrub panels (5015) Instrument, 2-Acrylic boxes, 2-Wiper holders, 2-Space plates 2mm, 2-Space plates 4mm, 4-pre-cut wiper blades, 200g scale, Sample pan
Voltage	100 - 240 V, 50/60 Hz
Dimensions	48.3 x 27.9 x 19.1 cm (19 x 11 x 7.5 in.)
Weight	14.5 kg (32 lbs)
Scrub Rate	6 - 60 cycles/minute
Stroke Length	25.4 cm (10 inch) standard setting* 22.9 cm (9 inch), 27.9 cm (11 inch) optional settings* 13.0 cm (5.1 inch) - ECE 43 version only (5097)

***Note:**

Stroke length is measured from the center brush location. To measure the stroke length from the brush end, add 8.9 cm (3.5 inches) to the center stroke length.

Optional stroke lengths must be set by local service center.

New!



Gardner-scrub, ECE 43

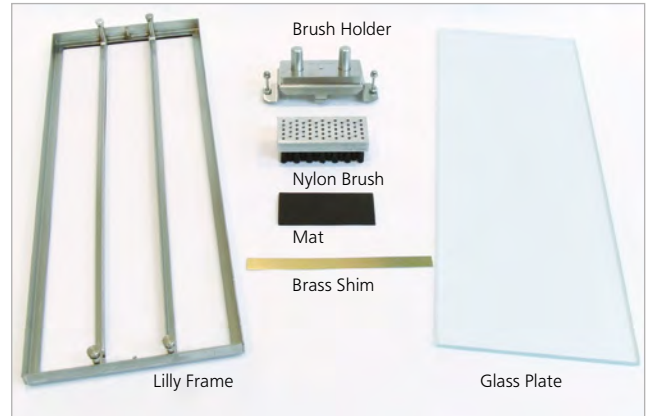

ASTM D 2486 Accessories



ISO Method Accessories

Gardner-scrub

Accessories



DIN Brush Holder (5075) and DIN Brush (5010)

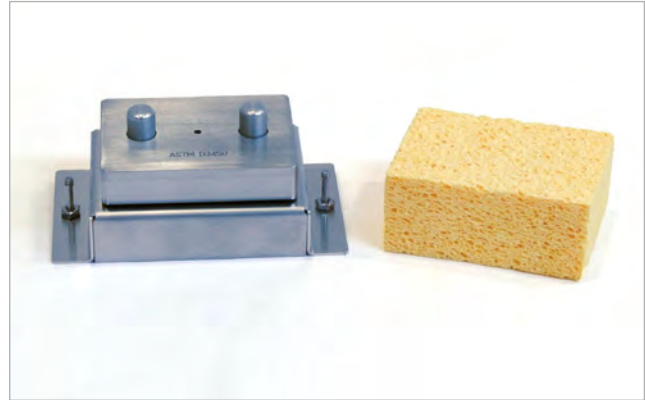

Sponge Holder (5073) and Sponge (8116)
for ASTM D3450 and D4828



Ordering Information

Cat. No.	Description
5064	Accessory Kit, ASTM D 2486
5065	Accessory Kit, ISO 11998
5066	Accessory Kit, DIN 53778
5067	Accessory Kit, ASTM D 4213
5068	Accessory Kit, ASTM D 4828
5069	Accessory Kit, ASTM D 3450
5074	Brush Holder and Mat, ASTM
5075	Brush Holder and Mat, DIN
6979	Brass Shim
5011	Nylon Brush
5010	Hog Bristle Brush, DIN
5038	Lilly Frame
5037	Liquid Metering System
5093	Holding Clamp/Burette Assembly with Holding Clamp
5012	Scotch Brite Pads (pk of 50)
5076	ISO Pad Holder
5059	ISO Arm Adapter
5019	Replacement Mat
5098	ISO Standard Dirt
5099	Wiper Blades, 25 pcs.

Accessories

Information
Includes: ASTM brush holder & mat (5074), Nylon brush (5011), Lilly frame (5038), Brass shim (6979), Glass plate (6980)
Includes: 1-Pad holder (5076), ISO Arm adapter (5059), Scotch brite pads (pk of 50) (5012), Glass plate (6980)
Includes: DIN Brush holder & mat (5075), Hog bristle brush (5010), Liquid metering system (5037), Glass plate (6980)
Includes: Sponge holder 450g (5072), Polyurethane sponge (5071), Scotch brite pad (5070), Lilly frame (5038), Glass plate (6980)
Includes: Sponge holder 1000g (5073), Sponge (8116), Glass plate (6980)
Includes: Sponge holder 1000g (5073), Weight 500g (5078), Sponge (8116), Glass plate (6980)
Needed for ASTM D 2486, Dimensions: 1.5 x 3.5 inches (38.1 x 88.9 mm)
Needed for DIN 53778
Needed for ASTM D 2486
Needed for ASTM D 2486
Needed for DIN 53778
Needed for ASTM D 2486; Designed for 1, 2, or 3 brush operation
Needed for DIN 53778; consists of stand, burette assembly, Glass tube, stop cock, clamp
Needed for 2 or 3 brush operation
Needed for ISO 11998
Needed for ISO 11998
Needed for ISO 11998, can hold up to 3 pad holders (5076)
For brush holder 5074, 5075
4.4 liters (1.0 gallon) dry, ISO 12103-1, A4. for ECE 43 model (5097)
65 cm (25.6 in.) length per blade, for ECE 43 model (5097)

Gardner-scrub

Accessories



1000 Gram Weight (5073) and 500 Gram Weight (5078)

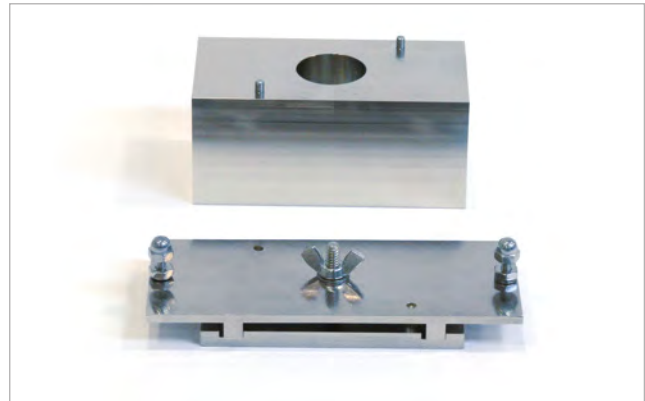

Sand Paper Holder Weight (8118) and Sandpaper Holder (5058)



Ordering Information

Cat. No.	Description
5072	Sponge Holder, 450g
5073	Sponge Holder, 1000g
5078	Weight, 500g*
5079	Weight, 1000g*
8116	Sponge, cellulosic (each)
5077	Sponge, B, cellulosic (pack of 6)
5071	Sponge, Polyurethane (pack of 6)
5070	Scotch Brite Pad, ASTM
6980	Glass Plate
5041	Sample Pan
8129	Scrub Media, Abrasive 474 ml (1 pint)
8130	Scrub Media, Non-abrasive 474 ml (1 pint)
5015	byko-chart Black Scrub Panels, P121-10N
5016	byko-chart White Scrub Panels, P122-10N
8113	Hog Bristle Brush, ANSI
8111	Hog Bristle Brush
8117	Sandpaper Attachment Kit
5058	Sandpaper Holder
8118	Weight, for Sandpaper Holder
2230	Dow Latex Applicator

***Note:** The weights can not be used with the brush holder (5074) and sponge B (5077) in combination. These weights are not designed for Sandpaper Holder (5058).

Accessories

Information
Needed for ASTM D 4213.
Dimensions: 3.0 x 3.75 x 0.875 inch (76.2 x 95.3 x 22.2 mm)
Needed for ASTM D3450, D4828.
Dimensions: 3 x 3.75 x 1.0 inch (76.2 x 95.3 x 25.4 mm)
Fits on top of Brush and Sponge holders
Fits on top of Brush and Sponge holders
Needed for ASTM D3450, D4828, MPI 138.
Dimensions: 3.0 x 3.75 x 1.5 inch (76.2 x 95.3 x 38.1 mm)
Designed for Brush Holder 5074. Dimensions: 1.5 x 3.5 inch (38.1 x 88.9 mm)
Needed for ASTM D4213. 3.0 x 3.75 inch (76.2 x 95.3 mm)
Needed for ASTM D 4213. Dimensions: 3.0 x 3.75 inch (76.2 x 95.3 mm)
Needed for ASTM, ISO, DIN methods
Replacement; Comes standard with base model
Needed for ASTM D 2486 / ASTM 3450
Needed for ASTM D 3450 / ASTM 4213
Box of 100; Needed for ASTM, DIN, and ISO methods,
Dimensions: 165 x 432 x 0.25 mm (6.56 x 17 x 0.01 in.)
Box of 100; Dimensions: 165 x 432 x 0.25 mm (6.56 x 17 x 0.01 in.)
Perforated back for ANSI method Z 124.1; Fits brush holder 5074 & 5075
General use, 3.5 x 1.5 in. (8.9 x 3.8 cm); Fits brush holder 5074 & 5075
Meets method MIL-E-11237 specification; Includes Sandpaper holder, Rubber mat, 10 yards (914 cm) x 2 inch (5.1 cm) of 1/0 and 3/0 emory cloth.
Needed for ASTM D 6736. Designed to hold any flat, thin sheet or cloth-type material with a minimum size of 2 x 5 inch (50.8 x 127 mm). Weight: 1 lb (454 gm)
Weight: 3.5 lbs (1.59 kg)
Needed for ASTM D 2486.

Abrasion Scrub Tester

The Wet Abrasion Tester produces a repeatable, controlled condition to simulate everyday use or wear patterns. The abrasion tester can examine washability and related properties that affect the stain resistance of coatings. Detergent performance testing can also be determined in a reproducible manner.

- Features two brush holders for side by side testing
- Air cooled electric motor for maximum reliability
- Peristaltic fluid pump – no reagent contamination (optional for 5002, 5007)
- Five digit preset counter – activates the machine for preset number of strokes, then switches off
- Can be modified to meet DIN, ISO, or ASTM scrub abrasion and washability test methods

Liquid solutions are pumped to the brush heads from the detachable container mounted to the side of the tester. The pump may be switched on or off during the course of testing, and the flow can be adjusted for precise dosing.



Standards

ASTM	D 2486, D 3450, D 4213, D 4828
DIN EN	53778, 13 300
ISO	11998
ANSI	Z124.1.2
ECE	43



Ordering Information

Cat. No.	Description
5000	Abrasion Tester, DIN, 220V
5004	Abrasion Tester, DIN, 115V
5002	Abrasion Tester, ISO, 220V
5007	Abrasion Tester, ISO, 115V
5005	Abrasion Tester, ASTM D2486, 220V
5008	Abrasion Tester, ASTM D2486, 115V
5047	Abrasion Tester, ASTM D3450, 220V
5046	Abrasion Tester, ASTM D3450, 115V
5051	Abrasion Tester, ASTM D4213, 220V
5050	Abrasion Tester, ASTM D4213, 115V
5055	Abrasion Tester, ASTM D4828, 220V
5054	Abrasion Tester, ASTM D4828, 115V

Comes complete with:

Abrasion Tester, 2 abrasive holders and 2 method specific abrasives, 100 scrub test panels, peristaltic fluid pump (excluded for 5002, 5007 models)

Technical Specifications

Standard	Scrub Rate (cycles/minute)	Stroke Length	Power Supply
DIN 53778	36 - 38	adjustable: 100 to 300 mm	220V, 50 Hz
DIN 53778	36 - 38	adjustable: 100 to 300 mm	115V, 60 Hz
ISO 11998, DIN EN 13300	36 - 38	adjustable: 100 to 300 mm	220V, 50 Hz
ISO 11998, DIN EN 13300	36 - 38	adjustable: 100 to 300 mm	115V, 60 Hz
ASTM D 2486	36 - 38	adjustable: 100 to 300 mm	220V, 50 Hz
ASTM D 2486	36 - 38	adjustable: 100 to 300 mm	115V, 60 Hz
ASTM D 3450	36 - 38	adjustable: 100 to 300 mm	220V, 50 Hz
ASTM D 3450	36 - 38	adjustable: 100 to 300 mm	115V, 60 Hz
ASTM D 4213	36 - 38	adjustable: 100 to 300 mm	220V, 50 Hz
ASTM D 4213	36 - 38	adjustable: 100 to 300 mm	115V, 60 Hz
ASTM D 4828	36 - 38	adjustable: 100 to 300 mm	220V, 50 Hz
ASTM D 4828	36 - 38	adjustable: 100 to 300 mm	115V, 60 Hz
Dimensions	660 x 480 x 420 mm (26 x 19 x 16.5 in)		
Shipping Weight	32 kg (70.5 lbs)		

Abrasion Scrub Tester Accessories



Ordering Information

Cat. No.	Description
5001	Modification Kit ASTM D2486
5003	Modification Kit ISO
5006	Modification Kit DIN
5048	Modification Kit ASTM D3450
5052	Modification Kit ASTM D4213
5056	Modification Kit ASTM D4828
5010	DIN Brush
5011	ASTM D2486 Brush
5012	ISO Pad
5017	Brass Shims ASTM D2486
5016	White Scrub Panel P122-10N
5015	Black Scrub Panel P121-10N
8129	Scrub Medium ASTM D2486
8130	Scrub Medium ASTM D3450
5049	Sponges ASTM D3450
5053	Sponges ASTM D4213
5057	Sponges ASTM D4828
5094	Wiper Method Accessory Kit

Accessories

Carriage assembly for ASTM D 2486, includes 2 brushes
Carriage assembly for ISO 11998, includes 2 abrasive pads
Carriage assembly for DIN 53778, includes 2 brushes
Carriage assembly for ASTM D 3450, includes 2 sponges
Carriage assembly for ASTM D 4213, includes 2 abrasive pads
Carriage Assembly for ASTM D 4828, includes 2 sponges
Meets DIN 53778; Dimensions: 38 x 89 mm (1.5 x 3.5 in)
Meets ASTM D 2486; Dimensions: 38 x 89 mm (1.5 x 3.5 in)
Meets ISO 11998; Pack of 50 pads
2 pieces required for ASTM D 2486.
For ISO and ASTM Methods; Pack of 100 plastic white scrub test panels; Dimensions: 165 x 432 x 0.25 mm (6.5 in x 17 in x 10 mils)
For ASTM Methods; Pack of 100 plastic black scrub test panels; Dimensions: 165 x 432 x 0.25 mm (6.5 in x 17 in x 10 mils)
For ASTM D 2486
For ASTM D 3450
Pack of 12, for ASTM method D 3450
Pack of 12, for ASTM method D 4213
Pack of 12, for ASTM method D 4828
For ECE 43 standard: 2-Acrylic boxes, 2-Distance plates 2mm, 2-Distance plates 4mm, 2-Wiper holders, 2-Wiper counter holders

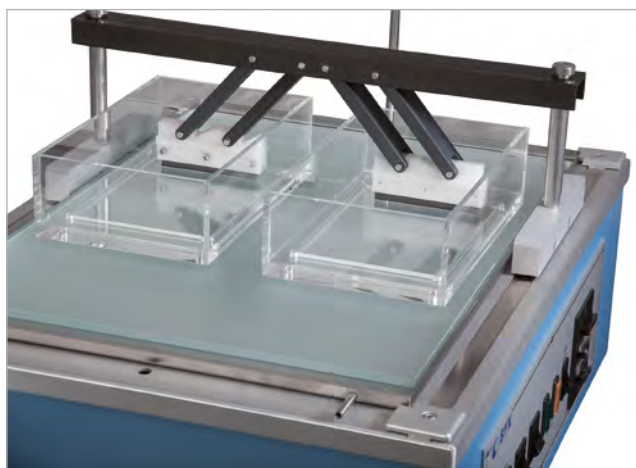

Wiper Method Accessory Kit (5094)

Introduction

Adhesion

In order to perform satisfactorily, coatings must adhere to the substrates on which they are applied. In practice, three different test procedures are used to assess the resistance of paints and coatings to separation from substrates:

Cross-Cut Test

This test method specifies a procedure for assessing the resistance of paints and coatings to separation from substrates when a right-angle lattice pattern is cut into the coating, penetrating through to the substrate.

The method may be used for a quick pass/fail test. When applied to a multi-coat system, assessment of the resistance to separation of individual layers of the coating from each other may be made.

Scrape Adhesion

This test method covers the determination of the adhesion of organic coatings such as paint, varnish, and lacquer when applied to smooth, flat (planar) panel surfaces. It has been found useful in providing relative ratings for a series of coated panels exhibiting significant differences in adhesion.

The materials under test are applied at uniform thickness to flat panels, usually sheet metal of uniform surface texture. After drying, the adhesion is determined by pushing the panels beneath a rounded stylus or loop that is loaded with increasing amounts of weight until the coating is removed from the substrate surface.

Pull-Off Test

Adhesion of a single coating or a multi-coat system of paint, varnish or related products is assessed by measuring the minimum tensile stress necessary to detach or rupture the coating in a direction perpendicular to the substrate. This method maximizes tensile stress as compared to the shear stress applied by other methods such as scratch adhesion and results may not be comparable.

The test is performed by securing a loading fixture (dolly) perpendicular to the surface of the coating with an adhesive. After the adhesive is cured, a testing apparatus is attached to the loading fixture and aligned to apply tension perpendicular to the test surface. The force applied is gradually increased and monitored until either a plug of coating material is detached, or a specified value is reached.

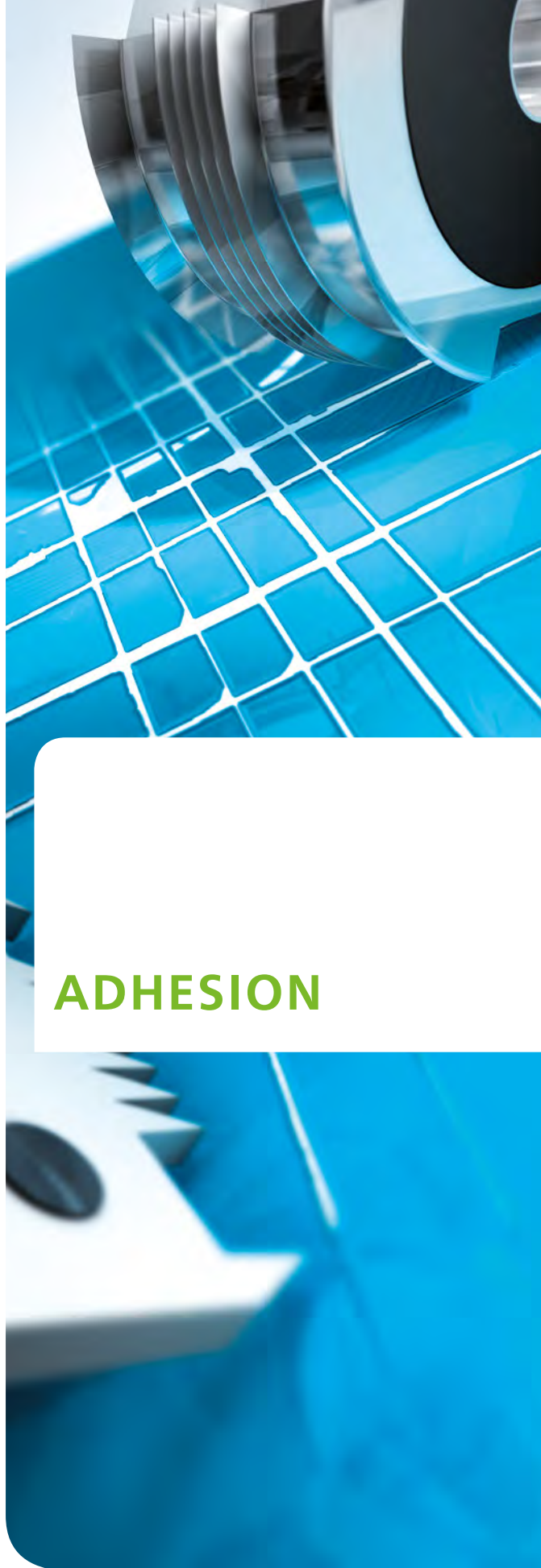

ADHESION

The cross-cut test is a simple and easily practical method for evaluating the adhesion of single- or multi-coat systems.

Procedure

- Make a lattice pattern in the film with the appropriate tool, cutting to the substrate
- Brush in diagonal direction 5 times each, using a brush pen or tape over the cut and remove with Permacel tape
- Examine the grid area using an illuminated magnifier

Cross-Cut Results

Adhesion is rated in accordance with the scale below.

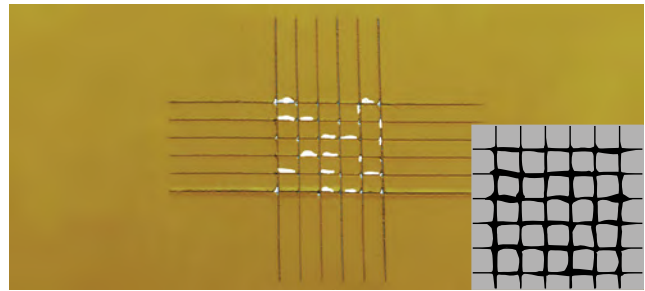

- ISO Class.: 2 / ASTM Class.: 3 B
The coating has flaked along the edges and/or at the intersections of the cuts. A cross-cut area significantly greater than 5 %, but not significantly greater than 15 %, is affected.

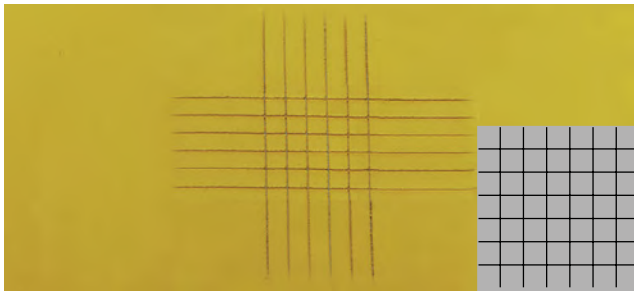

- ISO Class.: 0 / ASTM Class.: 5 B
The edges of the cuts are completely smooth; none of the squares of the lattice is detached.

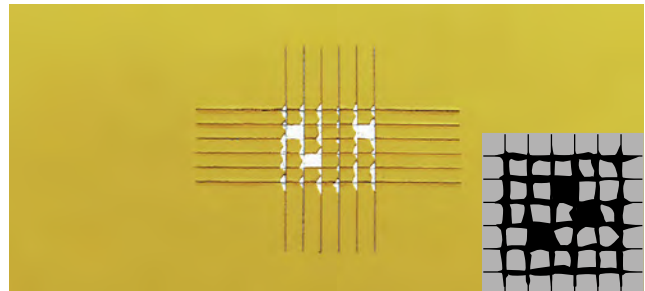

- ISO Class.: 3 / ASTM Class.: 2 B
The coating has flaked along the edges of the cuts partly or wholly in large ribbons, and/or it has flaked partly or wholly on different parts of the squares. A cross-cut area significantly greater than 15 %, but not significantly greater than 35 %, is affected.

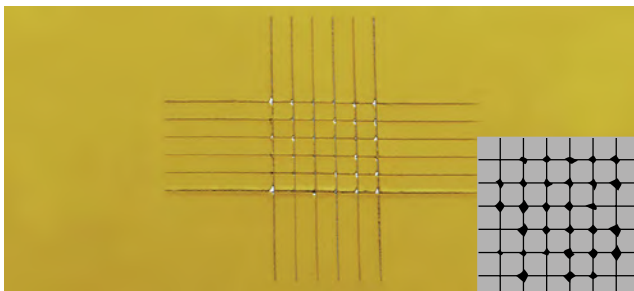

- ISO Class.: 1 / ASTM Class.: 4 B
Detachment of small flakes of the coating at the intersections of the cuts. A cross-cut area not significantly greater than 5 % is affected.



- ISO Class.: 4 / ASTM Class.: 1 B
The coating has flaked along the edges of the cuts in large ribbons and/or some squares have detached partly or wholly. A cross-cut area significantly greater than 35 %, but not significantly greater than 65 %, is affected.

Standard

ASTM	D 3002	D 3359
ISO		2409

- ISO Class.: 5 / ASTM Class.: 0 B
Any degree of flaking that cannot even be classified by classification 4.

Cross-Cut Tester Kit

Crosshatch Adhesion Kit

This method is used for determining the parallel groove paint adhesion of one or many layers on a substrate, generally a metal panel. Cross-Cut Tester Kits are available in 2 different crosscut blade versions, one is a multi-cut blade with 6 cutting edges, the other version has one cutting edge. The Cross Cut blades are made of hardened steel alloy and are designed for retaining a sharp cutting edge to reduce the frequency of blade replacement.

ASTM method D3359 requires 11 cut lines for 1 mm cutter:
 1 mm cutter for films up to 50 µm (2 mils) thick
 2 mm cutter for films between 50-125 µm (2 - 5 mils) thick

ISO standards ISO standards prescribe that the number of cuts shall be 6, and that the cut in each direction must be according to the film thickness and type of coating used as shown below:

- 0 - 60 µm 1 mm space for hard substrates (metal)
- 0 - 60 µm 2 mm space for soft substrates (plastic)
- 61 - 120 µm 2 mm space for hard or soft substrates
- 121 - 250 µm 3 mm space for hard or soft substrates



Standards

ASTM	D 3002, D 3359 Method B
ISO	2409
DIN	927-3



Ordering Information

Cat. No.	Description
5120	Cross-Cut Kit 6, 6-edges 1 mm
5122	Cross-Cut Kit 6, 6-edges 2 mm
5125	Cross-Cut Kit 6, 1-edge 1 mm
5126	Cross-Cut Kit 6, 1-edge 2 mm
5128	Cross-Cut Kit 6, 1-edge 3 mm
5123	Cross-Cut Kit 11, 1-edge 1 mm
5127	Cross-Cut Kit 11, 1-edge 1.5 mm
5121	Cross-Cut Kit 11, 6-edges 1.5 mm
5124	Cross-Cut Kit 6, 1-edge 2 mm

Comes complete with:

- Cross-Cut Tester kit with blade
- Hex wrench for changing blades
- Magnifier
- Cleaning brush
- Plastic carrying case
- Operating instructions
- One roll of adhesive tape in accordance with the standard

Technical Specifications

Standard	No. Of Teeth	No. Of Cutting Edges	Cutter Spacing	Hex Wrench included
DIN / ISO	6	6	1 mm (0.04 in)	--
DIN / ISO	6	6	2 mm (0.08 in)	--
DIN / ISO	6	1	1 mm (0.04 in)	yes
DIN / ISO	6	1	2 mm (0.08 in)	yes
DIN / ISO	6	1	3 mm (0.12 in)	yes
ASTM	11	1	1 mm (0.04 in)	yes
ASTM	11	1	1.5 mm (0.06 in)	yes
ASTM	11	6	1.5 mm (0.06 in)	--
ASTM	6	1	2 mm (0.08 in)	yes

Cross-Cut Tester Kit made of high alloy steel

Cross-Cut Tester Accessories

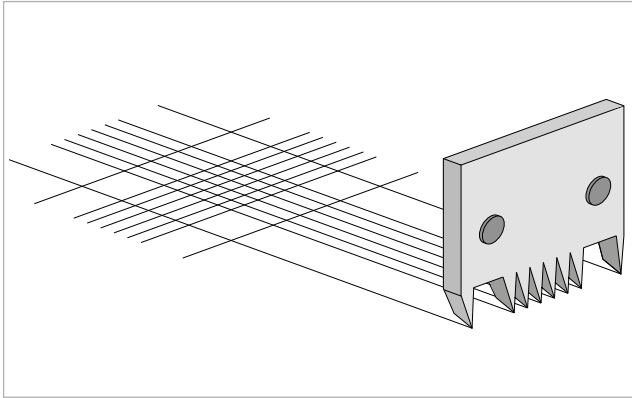

1 cutting edge

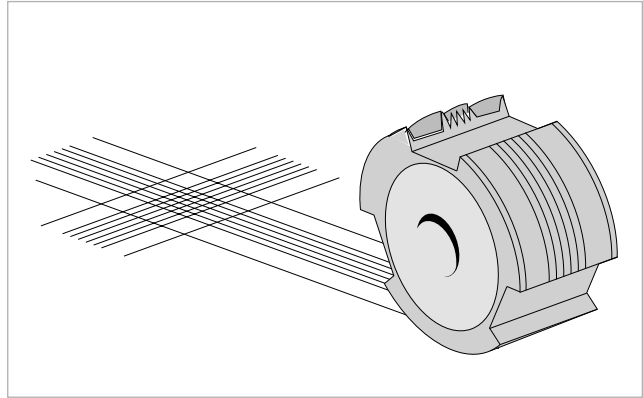

6 cutting edges



Ordering Information

Cat. No.	Description
5132	Cross-Cut Blade 6, 6-edges 1 mm
5134	Cross-Cut Blade 6, 6-edges 2 mm
3425	Cross-Cut Blade 6, 1-edge 1 mm
5129	Cross-Cut Blade 6, 1-edge 3 mm
3426	Cross-Cut Blade 6, 1-edge 2 mm
3429	Cross-Cut Blade 11, 1-edge 1 mm
3424	Cross-Cut Blade 11, 1-edge 1.5 mm
5133	Cross-Cut Blade 11, 6-edges 1.5 mm
5135	Brush
5136	Magnifier
5137	Adhesive Tape for DIN/ISO
8660	Adhesive Tape for ASTM

Accessories

for Cat. No	Standard	No. Of Cutting Teeth	No. Of Cutting Edges	Cutter Spacing
5120	DIN / ISO	6	6	1 mm (0.04 in)
5122	DIN / ISO	6	6	2 mm (0.08 in)
5125	DIN / ISO	6	1	1 mm (0.04 in)
5128	DIN / ISO	6	1	3 mm (0.12 in)
5126 5124	DIN / ISO	6	1	2 mm (0.08 in)
5123	ASTM	11	1	1 mm (0.04 in)
5127	ASTM	11	1	1.5 mm (0.06 in)
5121	ASTM	11	6	1.5 mm (0.06 in)
Spare brush for cross-cut tester kits				
Spare magnifier for cross-cut tester kits, 3x - 6x magnification				
Tesapack 4124, 50 mm x 66 m				
IPG 51596, 1 in x 72 yds				



Info!

Universal paint inspection:
 – Film thickness
 – Indentation hardness
 – Adhesion
 see byko-cut universal in Film Thickness section



Info!

For more information about how to evaluate test results with the new Digital Pocket Microscope, see DPM 300 in the Microscope section

Hoffman Scratch Hardness Tester

Scrape Adhesion Test

The Hoffman Scratch Hardness Tester was developed for the comparative evaluation of scratch resistance and adhesion of many types of coatings.

- Simple pocket size tester
- Ideal for field use and demonstrations

This instrument consists of a four-wheeled carriage, a scale arm graduated from 0-20 that is attached permanently to the carriage in a counterpoised condition about the pivot axis, and a scratch tool with a sharp circular rim mounted at 45° to the flat test surface.

Procedure

To operate, attach riders to the scale arm at the numbered positions. The carriage is held down firmly by hand and moved in the opposite direction, to cause a trailing scratch. The large standard rider loads 100 g per division, while the small rider loads 25 g per division. This small rider may be used for making low-range measurements involving small increments of pressure, or it may serve as a vernier with the large rider in making more precise medium-range measurements.

Scratch Hardness

The force necessary to cut through the film to the substrate.

Adhesion

The force required to scrape a path through the film, when the stylus begins its motion on an uncoated portion of the panel.

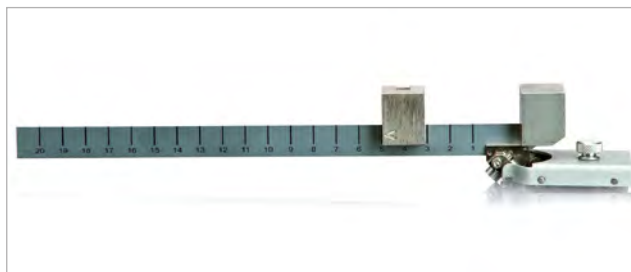

Standards

GE Aircraft Engine E50TF61-S1

Group Spec.

Naval Lab Spec. WS12858 Part 4.5.5 Hardness

Ordering Information

Cat. No.	Description
1610	Hoffman Scratch Tester

Comes complete with:

- One large standard rider
- One small rider and one extra scratching tool
- Carrying case
- Operating instructions

Technical Specifications

Dimensions	Net Weight	Shipping Weight
28 x 3.8 x 2.5 cm (11 x 1.5 x 1 in)	0.7 kg (1.5 lbs)	1.8 kg (4 lbs)

Ordering Information

Cat. No.	Description
1611	Scratching Tool
1612	Large Rider 100g
1613	Small Rider 25g

Accessories

- Replacement
- Equipped with friction clip for extending upper range of the Hoffman Scratch Hardness Tester
- Equipped with friction clip for improving precision in all ranges of the Hoffman Scratch Hardness Tester

Balanced Beam Scrape Adhesion and Mar Tester

Used to perform scrape adhesion and mar resistance (scratch hardness) tests of coatings and surfaces of various materials.

- For differentiating the degree of adhesion of coatings to substrates
- Provides relative ratings for a series of coated panels

This instrument consists of a pivoted beam with a 45° stylus holder, weight post and holder for supporting the total test load mounted on one end. On the other end of the beam is a counterweight. A cam is rotated to lower and raise the stylus and a sample bed mounted on ball bearings is used to move the test panel against the stationary stylus.

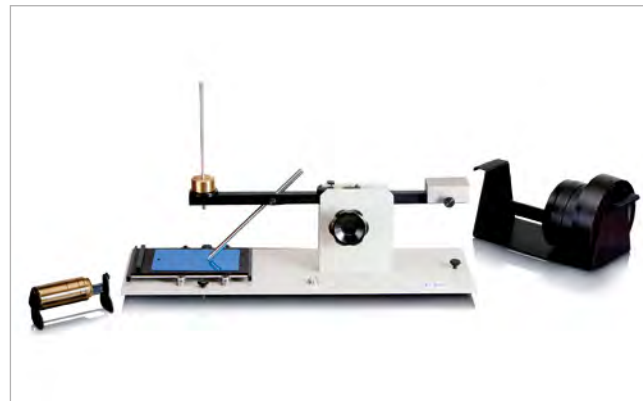

Scrape Adhesion Test

The stylus used for scrape adhesion is a 1.6 mm (0.0625 inch) drill rod, bent to a 180° loop with 6.5 mm (0.256 inch) OD, hardened, buffed and chrome plated. Supplied with the tester is a set of twelve slotted weights with storage rack. In the adhesion test, weights are applied in 0.5 kg increments to a maximum of 10 kg. By moving a free edge of the test film against the loop stylus under variable load expressed in grams, scrape adhesion resistance is the minimum load required to cut through the film to the substrate.

Mar Resistance Test

The mar test is similar to the scrape adhesion procedure. The loop stylus is placed directly onto test film surface under a starting load. Weight is added until mar is observed. Mar resistance is the ability of the coating to resist surface damage under mechanical force.

Standards

ASTM	D 2197, D 2248, D 2454, D 5178
FTMS	141a, Method 6303.1
General Electric	F50TF7-S1
Company Spec.	
Military Spec.	MIL-P-7788H



Ordering Information

Cat. No.	Description
5780	Balanced Beam Adhesion/Mar Tester

Comes complete with:

Tester
 Loop stylus and needle stylus;
 Weight post and holder
 Weight rack and set of 12 weights:
 1 x 10gm, 2 x 20gm; 1 x 50gm; 1 x 100gm; 2 x 200gm;
 1 x 500gm; 1 x 1000gm; 2 x 2000gm; 1 x 5000gm;
 Operating instructions

Technical Specifications

	Dimensions	Net Weight	Shipping Weight
	203 x 610 x 381 mm (8 x 24 x 15 in)	23.1 kg (51 lbs)	25.9 kg (57 lbs)



Ordering Information

Cat. No.	Description
5781	Loop Stylus
5782	Needle Stylus
5783	Rod Stylus
5784	Ball Point 1/8 in
5785	Ball Point 1/16 in
5786	Spit stylus
1611	Hoffman Scratch Tool
5787	Stylus Holder
6977	Weight Set
6972	Weight 1000 gm
6974	Weight 2000 gm
6976	Weight 5000 gm

Accessories

Replacement; U shaped stylus
Replacement needle stylus: 0.15 mm (0.006 inch) diameter
Tungsten steel, 1.6 mm (0.064 inch) diameter
3.2 mm (1/8 inch) ball
1.6 mm (1/16 inch) ball
Larger diameter needle stylus, 60° point, 1.9 mm (0.077 inch) diameter
To perform the Hoffman scratch test
Replacement Cylindrical steel rod
Replacement; 1 x 10 gm; 2 x 20 gm; 1 x 50 gm; 1 x 100 gm; 2 x 200 gm; 1 x 500 gm
Replacement; 1 x 1000 gm
Replacement; 1 x 2000 gm
Replacement; 1 x 5000 gm

PosiTest Family

Pull-Off Adhesion Test

The PosiTest pull-off adhesion testers measure paint adhesion on metal, wood and other rigid substrates. This easy-to-use, reliable and versatile instrument uses hydraulic pressure and a revolutionary self-aligning dolly to ensure uniform pull distribution over the surface being tested, preventing a one-sided pull-off. This is done using a ring of small ball bearings to engage the articulating dolly head.

There are two models available. The model AT-A Automatic Pull-Off Adhesion Tester and Model AT manual version. Both models have the following features:

- Portable, hand-operated instrument can be used in any position and requires no external power source-ideal for the lab and on-site
- Large scale reads clearly and easily in PSI and MPa
- Inexpensive, single-use dollies eliminate the need for heating, cleaning, or brushing for re-use
- Self-aligning dolly enables measurement on smooth or uneven surfaces without adversely affecting the test results.
- Heavy-duty hydraulic pump with safety valve helps prevent damage to pressure system
- Quick-coupling makes securing dollies in actuator simple, fast and trouble-free
- Multi-purpose, high-tensile two-part adhesive suitable for use with a wide variety of coatings and coating thicknesses
- Cutting tool for isolating test area is included
- Coating adhesion tester pressure system is calibrated and certified to $\pm 1\%$ accuracy (full-scale) and comes with a two-year warranty
- Internal memory stores up to 200 pulls. This includes maximum pull-off pressure, rate of pull, test duration, and dolly size
- Optional PosiSoft software available to upload test results
- USB Port PC interface
- 10, 14, 20, and 50mm dollies to maximize the measurement resolution and test range



Model AT



Model ATA-20

PosiTest Model ATA-20

The automatic model has a electronically controlled hydraulic pump that applies continuous pressure. The pull-off rate is user-selectable. Simple push button operation, eliminates the need to close valves or reset scales. A rechargeable NiMH battery is built-in providing up to 200 tests per charge. A universal AC Adapter is supplied. The Model ATA-20 has a high resolution screen, a wireless connection to a smart device, and records the nature of the failure: cohesion, adhesion, or glue failure.

Standards

ASTM	D 4541, D 7234
ISO	4624, 16276-1

Technical Specifications

Adhesion Strength	Resolution	Dolly Size
0-20 MPa (0-3000 psi)	± 0.01 MPa (± 1.0 psi)	20 mm
0-20 MPa (0-3000 psi)	± 0.01 MPa (± 1.0 psi)	20 mm
Case Dimensions	43 x 33 x 15 cm (17 x 13 x 6 in)	
Unit Weight	5.5 kg (12 lbs)	



Ordering Information

Cat. No.	Description
2201	PosiTest AT
5142	PosiTest ATA-20

Comes complete with:

- Adhesion Tester with digital display
- Hydraulic pump and actuator
- Aluminum test dollies (20 mm)
- Cutting tool for 20 mm dollies
- Adhesive, 1.5 meter (5 ft.) flexible hose
- Adhesive mixing sticks and palettes (5 each)
- 2-year warranty and carrying case
- USB Cable
- Certificate of calibration

PosiTest AT Verifier

Allows the user to verify the accuracy of PosiTest Adhesion Testers

- High precision load cell and hand-held smart sensor
- Fitted with a permanent 20 mm dolly
- A conversion factor is used to verify the other dolly sizes
- Portable - requires no external power supply
- Comes with a NIST traceable certificate of calibration for load cell and smart sensor
- Range 34.5 MPa (5,000 psi), accuracy ± 0.044 MPa (± 6.33 psi)

Dollies

Several dolly sizes are available: **10, 14, 20, and 50 mm.**

The larger surface area dolly provides improved low range repeatability.

Dolly Size (mm)	Maximum Pull-off Pressure
10	70 MPa (10,000 psi)
14	40 MPa (6,000 psi)
20	20 MPa (3,000 psi)
50	3.5 MPa (500 psi)

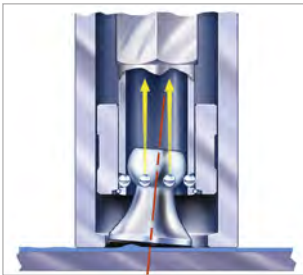

Self-aligning dolly



Ordering Information

Cat. No.	Description
0032	Adhesive Kit
0035	Accessory Kit 50 mm
5138	Dolly Set 10 mm
0030	Dolly Set 20 mm
5139	Dolly Set 14 mm
0031	Dolly Set 50 mm
0033	Cutting Tool, 50mm
0036	Cutting Tool, 14mm
5141	PosiTest Verifier Kit

Accessories

Includes adhesive, mixing sticks, palettes, cotton swabs
Includes 50 mm stand-off, hole saw, and test dollies (12)
set of 10pcs
set of 10pcs
set of 10pcs
set of 4pcs
For 50 mm dollies
For 14 mm dollies
Includes load cell, smart sensor, certificates, carry case, AC adapter

Single Impact Tester – esp-10

Chip Resistance Test

Resistance to chipping of multi-coat systems is an important factor in automotive finishing. To protect auto body parts, a multi-coat system is applied for corrosion and mechanical stress. The complete coating structure is decisive for its resistance to chipping. Changes to the coating formulation or application process can have an effect on the extent of the damage. The multi-impact test method - sharp-edged, chilled casting pieces are thrown against a test panel by compressed air - simulates the actual stress as closely as possible. However, the multi-impact test is difficult to reproduce. To improve the precision a single impact mechanism was developed.

The esp-10 was developed to test the resistance to chipping of multicoat systems. In addition, not only the size of the damaged area, but also its depth, i.e. the so-called "separation plane" can be evaluated.

- Portable instrument can be run in cooling chambers ($\geq -10\text{ }^{\circ}\text{C}$) and outside the laboratory
- Impact tool with wedge-shaped blade
- Compressed air of 3 bar accelerates the ball
- Testing instrument in accordance with BMW standard

Standards

DIN EN ISO	20567-2
------------	---------

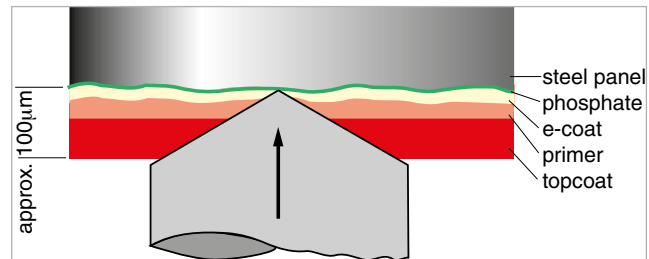

Ordering Information

Cat. No.	Description
5200	esp-10

Comes complete with:

Single Impact Tester esp-10
Weight
Connection hose
Operating instructions

Technical Specifications

Connection for Compressed Air	R 1/8"
Compresses Air Supply	5 bar
Working Pressure	3 bar
Operational Life of Impact Tool	approx. 1000 impacts
Additional Weight	1750 g (3.9 lbs)
Dimensions	35 x 32 x 23 cm (13.8 x 12.6 x 9.1 in)
Net Weight	8.6 kg (19 lbs)
Shipping Weight	10 kg (22 lbs)

Ordering Information

Cat. No.	Description
5824	Precision Microscope
5205	Standard for esp-10
5201	esp-10 Impact Tool

Accessories

To check performance of instrument with Certificate

High Quality Test Charts Eliminate Erroneous Lot Rejects

Consistent color and gloss guaranteed from print batch to print batch

Variations in gloss as well as color on test charts can cause erroneous rejection of paint batches. Pigments are added to improve contrast ratio when in fact it was not necessary, resulting in wasted raw materials and increased production costs to the paint manufacturer.

In order to avoid costly reject costs, it is crucial to control the quality of test charts for color (L^* , a^* , b^*) as well as gloss within tight tolerances for each new print batch.

Consistent color and gloss on test charts provide improved product quality, reduced raw material usage due to improper batch adjustments, greater production throughput, and reduced customer complaints. All of these improvements result in measurable cost savings in manufacturing and R&D.

BYK-Gardner specifications for byko-charts are considerably tighter than the paint manufacturer's specification for color and gloss, and as a result, byko-charts have never been rejected.

Over the last 10 years, BYK-Gardner has kept meticulous product consistency records from all print batches. This data shows the clear superiority of the byko-charts versus competitive charts from print batch to print batch.

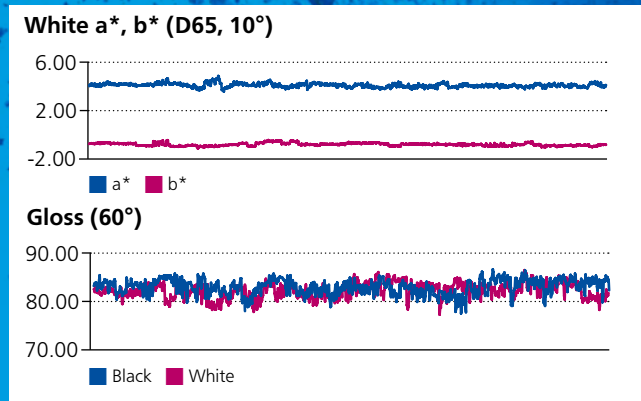

BYK-Gardner goes to great lengths to assure the quality of all the charts before, during and after the production process. A BYK-Gardner quality technician is on site testing the charts as lots are being produced. Prior to a lot being released for sale, random samples are collected across the entire chart run and subjected to extensive testing in the BYK-Gardner laboratory.

Storage of drawdown charts has also been found to be a serious problem when less than "ideal" storage conditions are used. For instance, in the hot humid days of summer, boxes of drawdown charts that are stacked in a warehouse or a delivery truck can quickly deteriorate making them totally unusable. Charts can stick together causing the coatings to be pulled off when attempts are made to separate the charts. Charts can also curl under high humidity conditions if not properly protected. ASTM D-4946 is a procedure to test for blocking (resistance of surfaces to stick together). BYK-Gardner had an independent laboratory conduct a test on byko-charts and the competitive drawdown charts using the ASTM D-4926 method. The byko-charts passed the test and the competitive charts failed. To prevent blocking and curl, BYK-Gardner wraps each box of byko-charts with a protective film that guards against humidity in the warehouse and during shipment.

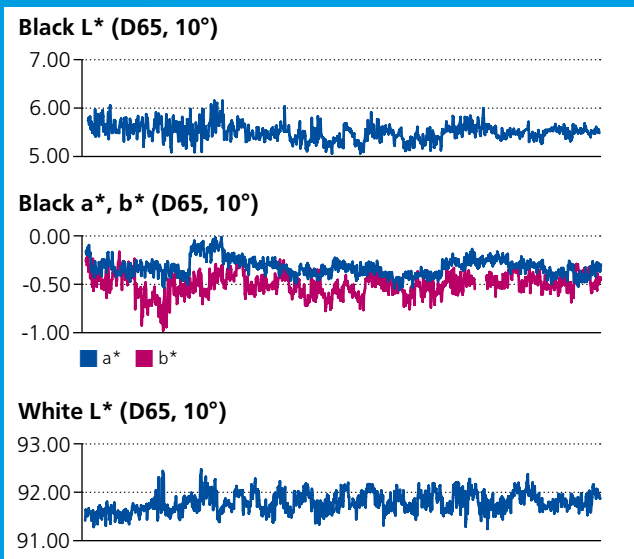

Introduction

Wet Film Preparation

An accurate and uniform film thickness is essential for achieving uniform color, appearance and specific physical properties such as scrub resistance, chip resistance, flexibility etc. Therefore, international specifications as well as company internal testing methods specify not only a minimum film thickness, but also require controlling the film thickness within a defined range.

The most common method of applying a liquid finish in the laboratory is with a drawdown bar or often referred to as a "doctor blade". This type of film applicator can lay down wet films of almost any desired thickness from a few μm up to 1000 μm (0.1 mil up to 40 mils).

A typical blade type applicator consists of a metal bar containing a gap of known clearance on one or more faces. It is placed near one end of a flat panel or drawdown chart. A sufficient volume of sample is placed in front of the applicator. The applicator is then "drawn down" the panel/chart, either automatically or manually, leaving a uniform film. The automatic method is more repeatable and will result in a more uniform film thickness over the entire range, as operator deviations are minimized.

Stainless steel, aluminum, or plated steel are the preferred materials of construction, due to their resistance to corrosion. Plated and stainless steel types are harder and will withstand more rigorous use. Regardless of the material of construction, corrosion can damage the region of the drawdown bar controlling thickness of the applied film, therefore affecting the repeatability of the instrument. Good lab practices dictate immediate cleaning of the instrument after each use to eliminate potential corrosion or residue which could affect future results.

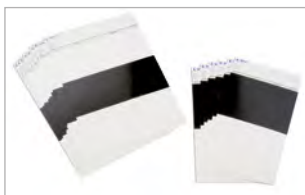

Drawdown Charts

APPLICATION

It is recommended that all units be periodically checked for accuracy by using a feeler gauge, as normal use and cleaning will, after time, render any applicator inaccurate. Should an applicator be dropped or the blade become nicked, it needs to be replaced as the applied film will no longer be equally distributed over the applicator's film width. Numerous types of applicators have evolved over the years and can be divided into two types: adjustable and fixed gap clearance. Applicators may also have single or multiple gaps. Most applicators have shoulders or side arms that hold the pool of sample in front of the gap, while the device is drawn down. The gap on most applicators has a flat shearing edge which yields a wet film to gap ratio of approximately 1 to 2, although this ratio varies with several factors, such as application technique and coating composition. Fixed models are easier to clean and maintain; adjustable models should be disassembled and cleaned after every use.

The quality of the draw down is governed by three main factors:

- Viscosity of the paint
- Speed and uniformity of the application
- Flatness of the surface

A variety of viscometers can be used to control viscosity.



Viscosity Cups



Rotational Viscometers



BYK-Gardner also offers an automated film applicator which controls the rate of application and planeness of the applicator, assuring a uniform film thickness.

The wet film to gap ratio is a result not only of the shape of the shearing edge, but the fluid's viscosity, the speed of the applicator and other factors. The exact wet or dry film thickness can be determined only by measuring the wet or dry film with a film thickness gauge.



Automatic Film Applicator



Wet film thickness measurement



Dry film thickness measurement

For very thin films, the use of wire-wound rods is recommended. These applicators are drawn across the surface in the same manner as the blade type, but the coating flows through the grooves between the wires and produces a thin, uniform drawdown.



Wire-wound rods

Due to liquid evaporation, dry film thickness will always be less than the wet film thickness of a particular coating. Likewise, because of physical properties, wet film thickness will always be less than the gap of the applicator. An operator will learn through experience the approximate wet film thickness that will be obtained with a specific combination of coating, applicator, and application method. Likewise, knowledge of the composition of the coating will tell the operator what dry film thickness to expect. A good rule of thumb for a beginning estimate of dry film thickness is as follows:

$$\text{Dry film thickness} = \frac{\text{wet film thickness} \times \text{Vol. \% solids}}{100}$$

The following table helps to estimate the relationship between the gap depth of the applicator and wet film thickness:

Gap Depth		Approximate Wet Film Thickness
mils	microns	
1-4	15 - 100	50% of gap depth
5-12	101-300	60% of gap depth
13-20	301-500	80% of gap depth
>20	>500	90% of gap depth

byko-charts

Drawdown Test Charts

BYK-Gardner offers a wide range of drawdown cards and charts for virtually any application and coating material. Stringent quality control during the production process assures that they have the most consistent color and gloss in the industry. Test charts are easy to use and an inexpensive substrate to test a variety of coating properties, such as opacity, spreading rate, penetration behavior, and flow & leveling behavior. They are used for testing architectural, industrial, automotive, wood finishes or even cosmetic products (e.g. nail polish). Depending on the material properties of the product to be tested and its usage different types of drawdown cards are available.



Selection of test charts dependent on coating technology:

Depending on the type of solvent used in paint formulations a drawdown chart needs to be more or less solvent resistant. The resin type requires different solvent types and dependent on the polarity of the solvent, the organic ingredients will be more or less activated. Therefore, BYK-Gardner offers two types of drawdown cards and charts:

byko-charts, clearcoated:

- Clearcoat top coated drawdown charts are ideal for a wide range of coating systems: water and solvent borne technologies
- Guaranteed non-fluorescent paper in compliance with ASTM D 344
- Repeatable color and gloss - lot after lot
- Superior film adhesion characteristics
- Rugged design (15 mils [381 micron] thickness) to prevent warping and bending after the coating is applied
- Draw-down chart box is shrink-wrapped with low permeability plastic to prevent moisture absorption during shipping and storage.
- Lot numbers are printed on every chart

byko-charts, film laminated:

- Plastic film laminated chart for excellent solvent resistance from achromatic hydrocarbons, esters, ketones and acids
- Repeatable color and gloss - lot after lot
- Smooth, structure free surface
- Superior adhesion properties and flexibility - the test chart will not warp and bend – even in high humidity environments

Selection of test charts dependent on application:

- Opacity charts: Instrumental check of % - opacity
- Penetration charts: Evaluation of color and gloss uniformity on surfaces of varying porosity
- Visual evaluation of hiding power:
 - Display / Spreading Rate Charts
 - Checkerboard / Spreading Rate Charts
- Brushout Cards for informal brushouts
- Uncoated test charts to simulate wood or unsealed wallboard substrates
- Specialty charts for sag and leveling test

Save!

Additional discounts are available for large quantity byko-charts drawdown charts purchases.

Info!

Custom made or private label charts are available upon request.

Opacity Drawdown Charts

Comprised of a simple combination of black and white areas with ample space for reflectance measurement. Opacity drawdown charts are used to test the hiding power of coatings.

Black and white areas have the tightest tolerances in the industry, ensuring repeatable opacity measurements paint batch after paint batch.

Clearcoated charts have the lot number printed on every chart.

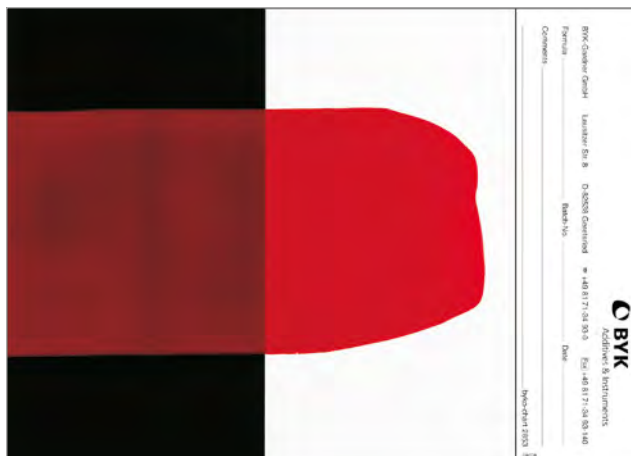

Cat. No. 2810
2813
2860

Cat. No. 2811

Cat. No. 2812

Cat. No. 2851

Cat. No. 2852

Standards

ASTM	D 344, D 2805, D 2243
ISO	6504-3



Ordering Information

Cat. No.	Description
2810	byko-chart Opacity 2A
2813	byko-chart Opacity 2C
2811	byko-chart Opacity 3B
2812	byko-chart Opacity 5C
2851	byko-chart Opacity L
2852	byko-chart Opacity S
2860	byko-chart brightened 2A

Technical Specifications

Material	Size	Qty/Box
Clearcoated	140 x 254 mm (5.5 x 10 in)	250
Clearcoated	194 x 260 mm (7.6 x 10.25 in)	250
Clearcoated	194 x 289 mm (7.6 x 11.4 in)	250
Clearcoated	194 x 260 mm (7.6 x 10.25 in)	250
Film laminated	148 x 210 mm (5.8 x 8.3 in)	250
Film laminated	105 x 147 mm (4.1 x 5.8 in)	250
Clearcoated	140 x 254 mm (5.5 x 10 in)	250

The 2860 byko-chart brightened drawdown chart has a brighter white section compared to the other opacity charts. The CIE L* value is approximately 2 units higher and the CIE b* value is approximately 2 units lower compared to the standard byko-charts. The black section is comparable to standard byko-charts. The paper does not have a brightening agent to achieve the whiter appearance.



Save!

SAVE up to 30% when you buy 4 or more boxes!

Penetration and Opacity Charts – Penopac

The test areas and functions of a penetration and opacity draw-down chart / drawdown card are combined with these charts. The penetration resistance is of special importance to architectural finishes. The ability to maintain a uniform appearance (color and gloss) on substrates with varying porosity can be evaluated by applying the paint over a test chart which has a coated and uncoated area. Thus, the penetration resistance is tested under severe conditions.

The penetration resistance is visually evaluated and can also be objectively evaluated by measuring color and gloss.

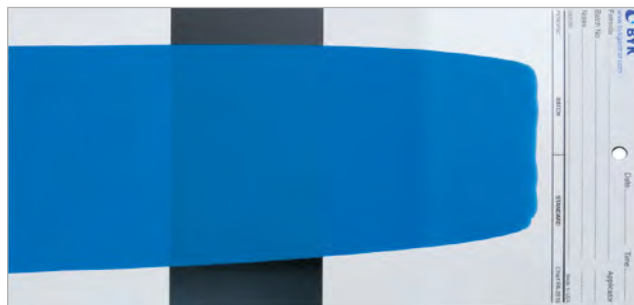

Save!

SAVE up to 30% when you buy 4 or more boxes!



Cat. No.
2818,2814

Cat. No.
2815, 2816

Cat. No.
2817



Ordering Information

Cat. No.	Description
2814	byko-chart Penopac 1A
2818	byko-chart Penopac 1B
2815	byko-chart Penopac 18A
2817	byko-chart Penopac 19BR
2816	byko-chart Penopac 18B

Technical Specifications

Material	Size	Qty/Box
Clearcoated / uncoated	140 x 254 mm (5.5 x 10.0 in)	250
Clearcoated / uncoated	194 x 289 mm (7.6 x 11.4 in)	250
Clearcoated / uncoated	140 x 254 mm (5.5 x 10.0 in)	250
Clearcoated / uncoated	194 x 289 mm (7.6 x 11.4 in)	250
Clearcoated / uncoated	194 x 289 mm (7.6 x 11.4 in)	250

Opacity Measurement

Essential sales criteria for architectural paint are hiding power and yield. In other words:

- How many layers are necessary for complete coverage?
- And how many cans will be needed?

Opacity is a measure for hiding power:

$$\text{Opacity (\%)} = \frac{\text{YBLACK} \times 100 (\%)}{\text{YWHITE}}$$

100% opacity means complete hiding, no differences can be seen between the drawdown over black and white.

Procedure

A uniform paint film is applied on a black / white contrast chart. After air drying the drawdown can be objectively evaluated using the BYK-Gardner spectro-guide. The operator is menu guided through the measurement procedure and the opacity value is displayed automatically in a second.

The same procedure can be applied for transparent films and plastics.



spectro-guide color spectrophotometer

Display Charts / Checkerboard Charts – Spreading Rate Charts

Large size drawdown charts, referred to as display or spreading rate charts, were designed for visual evaluation of hiding power. The diagonal striped patterns or the checkerboard respectively have a strong visual impact and emphasize variations in film opacity.

In order to calculate the spreading rate ASTM D 344 uses Forms 8H and 10H. In this test the paint is spread uniformly on a defined test area (0.1 square meters ~ 1 square foot) and the spreading rate is calculated from the weight and density of the applied coating.



Standards

ASTM D 344, D 2805

ISO 6504-3



Cat. No.
2819
2820



Cat. No.
2821



Cat. No.
2834



Cat. No.
2823

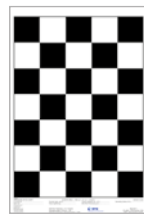

Cat. No.
2824

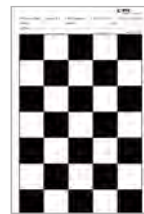

Cat. No.
2802



Cat. No.
2804



Cat. No.
2822



Ordering Information

Cat. No.	Description
2819	byko-chart Opacity-Display 9A
2820	byko-chart Opacity-Display 9B
2821	byko-chart Opacity-Display 21B
2834	byko-chart Display 8B
2823	byko-chart SR-Display 8H
2824	byko-chart SR-Checkerboard 10H
2802	byko-chart Spreading Rate L
2804	byko-chart Spreading Rate S
2822	byko-chart Opacity-Display 12H

Technical Specifications

Material	Size	Qty/Box
Clearcoated	140 x 254 mm (5.5 x 10 in)	250
Clearcoated	194 x 289 mm (7.6 x 11.4 in)	250
Clearcoated	194 x 289 mm (7.6 x 11.4 in)	250
Clearcoated	194 x 289 mm (7.6 x 11.4 in)	250
Clearcoated	286 x 438 mm (11.25 x 17.25 in)	125
Clearcoated	286 x 438 mm (11.25 x 17.25 in)	125
Film laminated	283 x 438mm (11.1 x 17.2 in)	250
Film laminated	148 x 210 mm (5.8 x 8.3 in)	250
Clearcoated	286 x 438 mm (11.25 x 17.25 in)	125

Plain Black Drawdown Chart

An all black chart can check opacity of a coating used over a dark primer or substrate. A visual assessment of sparkle or pearl appearance of special effect coatings and cosmetics can be easily viewed with a black background.



Ordering Information

Cat. No.	Description
2845	byko-chart Plain Black BK

Technical Specifications

Material	Size	Qty/Box
Clearcoated	218 x 288 mm (8.6 x 11.25 in)	250

Brushout Drawdown Cards

Made from heavy, rigid stock paper; used mostly for informal brushout applications. The paper stock is almost twice the thickness of regular drawdown chart paper to give greater rigidity for easier handling.



Cat. No.
2856

Cat. No.
2857

Cat. No.
2858



Ordering Information

Cat. No.	Description
2856	byko-chart Brushout 5DX
2857	byko-chart Brushout 2DX
2858	byko-chart Brushout WDX

Technical Specifications

Material	Size	Qty/Box
Clearcoated	100 x 152 mm (3.9 x 6.0 in)	500
Clearcoated	100 x 152 mm (3.9 x 6.0 in)	500
Clearcoated	100 x 152 mm (3.9 x 6.0 in)	500

Plain White Drawdown Charts

These drawdown charts are plain white with the coating on one side and no text or label on top (except 2835). The 2835 is an uncoated stock paper with a nominal thickness of 0.38 mm (15 mils).

Chromolux drawdown cards are for determination of whiteness. The Chromolux chart has a very smooth, high gloss surface, achieved by the paper being pressed against a hot metal plate.



Plain white

Save!

SAVE up to 30% when you buy 4 or more boxes!



Ordering Information

Cat. No.	Description
2827	byko-chart plain white WB*
2828	byko-chart plain white WH
2825	byko-chart plain white WG
2826	byko-chart plain white WA*
2837	byko-chart plain white WK
2829	byko-chart, plain white, square
2835	byko-chart plain white NWK*
2891	byko-chart Chromolux L
2892	byko-chart Chromolux M
2893	byko-chart Chromolux S

Technical Specifications

Material	Size	Qty/Box
Clearcoated	193 x 288 mm (7.63 x 11.33 in)	250
Clearcoated	286 x 438 mm (11.25 x 17.25 in)	125
Clearcoated	76 x 140 mm (3.0 x 5.5 in)	1000
Clearcoated	140 x 254 mm (5.5 x 10 in)	250
Clearcoated	218 x 288 mm (8.6 x 11.25 in)	250
Clearcoated	50.8 x 50.8 mm (2.0 x 2.0 in)	400
uncoated	193 x 288 mm (7.63 x 11.33 in)	250
Chromolux	283 x 438 mm (11.1 x 17.2 in)	250
Chromolux	210 x 297 mm (8.3 x 11.7 in)	250
Chromolux	148 x 210 mm (5.8 x 8.3 in)	200

*Note: These drawdown charts have a 6 mm (0.25 in) hole, centered 5 mm (0.2 in) from the top edge.

Birch Veneer Panel

Real wood laminated on paper. Birch has a neutral color with minimal grain pattern for color matching of stains.



Ordering Information

Cat. No.	Description
5096	Birch Venerer Panel, R7D

Technical Specifications

Material	Dimensions	Qty/Box
Birch Wood	76 x 152 mm (3.0 x 6.0 in)	100

Uncoated Drawdown Cards

Use these uncoated drawdown cards to simulate wood or unsealed wallboard.

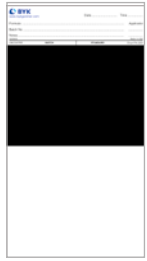

Cat. No.
2831
2832



Cat. No.
2838



Cat. No.
2805



Cat. No.
2855



Cat. No.
2885

Save!

SAVE up to 30%
when you buy
4 or more boxes!



Ordering Information

Cat. No.	Description
2831	byko-chart, uncoated N2A
2832	byko-chart, uncoated N2C
2838	byko-chart, uncoated N9A
2805	byko-chart, uncoated L
2855	byko-chart, uncoated M
2885	byko-chart, uncoated S

Technical Specifications

Material	Size	Qty/Box
uncoated	140 x 254 mm (5.5 x 10 in)	250
uncoated	194 x 260 mm (7.6 x 10.25 in)	250
uncoated	140 x 254 mm (5.5 x 10 in)	250
uncoated	210 x 297 mm (8.27 x 11.7 in)	250
uncoated	105 x 148 mm (4.13 x 5.83 in)	250
uncoated	75 x 185 mm (3.0 x 7.3 in)	250

Gray Scale Chart

The chart is sealed with bars of varying shades from black to light gray on a white background. The large poster size chart allows for applying a coating with a paint roller or brush. The chart can be hung to a wall to evaluate the hiding power of the the applied coating.



Ordering Information

Cat. No.	Description
2859	byko-chart, CU-1M

Technical Specifications

Material	Size	Qty/Box
Clearcoated	610 x 946 mm (24 x 37.25 in)	100

Drawdown Plate

Provides an economical and convenient means for making drawdowns of uniform film thickness.

- Easy to use and easy to clean
- Holds charts securely for drawdowns
- Helps to achieve uniform results

The drawdown plate consists entirely of glass 12.7 mm (0.5 in) in thickness. The all glass plate has rubber feet and a spring clip to hold the drawdown chart firmly in place.



Ordering Information

Cat. No.	Description
4262	Drawdown Plate, Glass

Technical Specifications

Glass plate Size	Dimensions	Net Weight	Application
254 x 355.6 mm (10 x 14 in)	254 x 355.6 x 12.7 mm (10 x 14 x 0.5 in)	3.2 kg (7.0 lbs)	general purpose for drawdowns on paper charts

Sag and Leveling Test Charts

This drawdown chart is designed for use with the NYPC Leveling Test Blade and the Anti-Sag Meter. The extra large black area allows measurements to be made over the black area only, in accordance with specifications that require the operator to ignore the leading and trailing edges of the drawdown.



Cat. No. 2833

Standards

ASTM D 4400



Ordering Information

Cat. No.	Description
2833	byko-chart Sag and Leveling 7B

Technical Specifications

Material	Size	Qty/Box
Clearcoated	193 x 286 mm (7.6 x 11.25 in)	250

Spray Monitors

These spray monitors are self-adhering, pressure-sensitive labels with a hiding power test pattern and a sealed, solvent-resistant surface. They are used with metal panels and other substrates where a uniform surface appearance provides no visual clues as to the thickness of the applied film. It adheres firmly whether air-dried or baked. They are useful for visually checking for film opacity during the painting process.



Cat. No.
2840

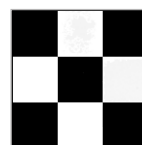

Cat. No.
2841



Ordering Information

Cat. No.	Description
2840	Spray Monitors M12-BW
2841	Spray Monitors M33-BW

Technical Specifications

Material	Dimensions	Qty/Box
Clearcoated	25 x 25 mm (1.0 x 1.0 in)	2000
Clearcoated	50 x 50 mm (2.0 x 2.0 in)	500

Inter-leaf Paper

The Inter-leaf Paper is designed to protect a dry paint film. Place the Inter-leaf Paper between the byko-charts. The Inter-leaf Paper has a non-stick surface. They protect the paint film from being marred and prevents the paint film from adhering to the chart stacked over it. The Inter-leaf Paper should be used when storing or shipping test charts.



Save!

SAVE up to 30% when you buy 4 or more boxes!



Ordering Information

Cat. No.	Description
2839	Inter-leaf Paper 1P-1B
2842	Inter-leaf Paper 1P-1A
2843	Inter-leaf Paper 1P-1C
2844	Inter-leaf Paper 1P-1K

Technical Specifications

Material	Dimensions	Qty/Box
non-stick	194 x 286 mm (7.62 x 11.25 in)	1000
non-stick	140 x 254 mm (5.5 x 10 in)	1000
non-stick	194 x 260 mm (7.62 x 10.25 in)	1000
non-stick	219 x 286 mm (8.62 x 11.25 in)	1000

Clear Polyester Film

The clear polyester film can be used as a substrate for coatings to evaluate color, gloss, and transparency. It is used to check for foam stabilization and de-flocculation of pigments, or placed over a black and white background for evaluation of hiding power. In addition, it is used as an overlay to protect a drawdown after drying without obscuring visibility.

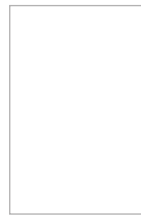

Clear polyester film

Save!

SAVE up to 30%
when you buy
4 or more boxes!



Ordering Information

Cat. No.	Description
2870	byko-chart PE film, 100 µm
2871	byko-chart PE film, 50 µm
2872	byko-chart PE film, 76 µm
2873	byko-chart PE film, 355 µm

Technical Specifications

Material	Dimensions	Qty/Box
Clear Polyester Film	127 x 194 mm (5.0 x 7.62 in)	250
Clear Polyester Film	127 x 194 mm (5.0 x 7.62 in)	250
Clear Polyester Film	216 x 280 mm (8.50 x 11.00 in)	250
Clear Polyester Film	127 x 194 mm (5.0 x 7.6 in)	250

Scrub Test Panel

Used in conjunction with the BYK-Gardner Abrasion Testers. These scrub test panels are the perfect substrate for all types of abrasion tests. The plastic panels are 0.25 mm thick (10 mils).



Cat. No.
5015



Cat. No.
5016

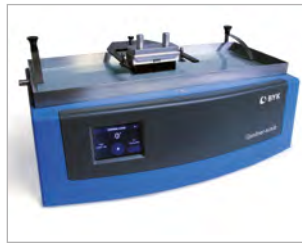

Abrasion Tester

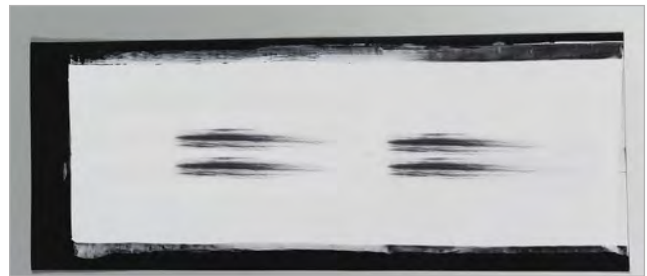

Standards

ASTM	D 2486, D 3450, D 4213
ISO	11998



Ordering Information

Cat. No.	Description
5015	Black Scrub Panel P121-10N
5016	White Scrub Panel P122-10N

Technical Specifications

Material	Size	Qty/Box
Plastic	165 x 432 mm (6.5 x 17 in)	100
Plastic	165 x 432 mm (6.5 x 17 in)	100

Black Glass Panel

Black glass is used in widely referenced high-precision ASTM method D2805, and related hiding power test methods. The coating is applied directly to the glass surface. The accuracy of this test method depends on the unique hardness and levelness characteristics of the glass substrate.

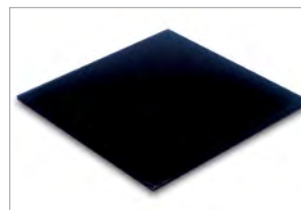

Standards

ASTM	D 2805
------	--------



Ordering Information

Cat. No.	Description
3720	Black Glass Panel

Technical Specifications

Material	Dimensions	Weight/Box
Glass	203 x 203 mm (8 x 8 in)	0.9 kg (2 lbs)

Bar Film Applicators

BYK Drawdown Bar film applicators are the highest quality and easiest to clean and maintain due to their simple design and rugged construction. The theoretical wet film thickness is etched onto every drawdown bar. The theoretical wet film thickness is roughly one-half the actual gap clearance. If you have a gap clearance of 6 mils, the theoretical wet film thickness etched on the bar applicator is 3 mils. We can not guarantee that you will drawdown the theoretical wet film thickness. The drawdown process consists of many variables. The actual wet film thickness can vary from 50% to 90% of the gap depending on the gap clearance.

- Every drawdown bar is certified in our lab and comes with a calibration certificate
- Packaged in a handy reuseable storage box to help prevent damage
- Made of 440-grade stainless steel, ground to tight tolerances for repeated use

Info! Trade in your old drawdown bar and get a new certified bar for less than the cost of recertification.

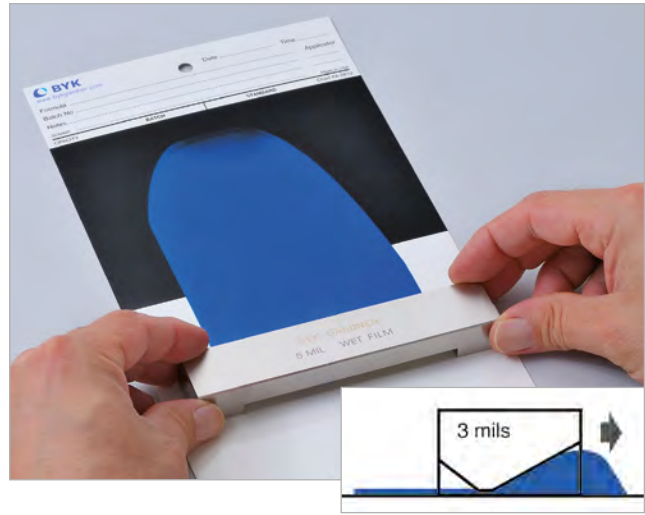

Standards

ASTM	D 823, D 3258, D 2243
Federal Spec.	TT-P-29, TT-E-508A, PD-220A
FTMS	141a
JAN	JAN-P-630, JAN-P-700
Military Spec.	MIL-P-13341



Ordering Information

Cat. No.	Description
5550	Single Bar 2", 3 mils
5551	Single Bar 2", 6 mils
5552	Single Bar 3", 1 mil
5553	Single Bar 3", 1.5 mils
5554	Single Bar 3", 3 mils
5555	Single Bar 3", 6 mils
5556	Single Bar 3.5", 1.5 mils
5557	Single Bar 3.5", 3 mils
5558	Single Bar 3.5", 5 mils
5559	Single Bar 3.5", 6 mils
5560	Single Bar 3.5", 10 mils
5561	Single Bar 6", 0.5 mils
5562	Single Bar 6", 1 mil
5563	Single Bar 6", 1.5 mils
5564	Single Bar 6", 2 mils
5565	Single Bar 6", 2.5 mils
5566	Single Bar 6", 3 mils
5567	Single Bar 6", 4 mils
5573	Single Bar 6", 5 mils
5568	Single Bar 6", 6 mils
5569	Single Bar 6", 8 mils
5570	Single Bar 6", 10 mils
5571	Single Bar 6", 12 mils
5572	Single Bar 6", 20 mils

Comes complete with:

- Drawdown Bar applicator
- Reuseable storage case
- Calibration Certificate - NIST traceable

Note: Drawdown bars can only be returned unused and in original packaging.

Technical Specifications

Theoretical Wet Film Thickness (mils)	Gap Clearance mils (µm)	Film Width inches (cm)
3.0	6.0 (152.4)	2 (5.08)
6.0	12.0 (304.8)	2 (5.08)
1.0	2.0 (50.8)	3 (7.64)
1.5	3.0 (76.2)	3 (7.64)
3.0	6.0 (152.4)	3 (7.64)
6.0	12.0 (304.8)	3 (7.64)
1.5	3.0 (76.2)	3.5 (8.91)
3.0	6.0 (152.4)	3.5 (8.91)
5.0	10.0 (254)	3.5 (8.91)
6.0	12.0 (304.8)	3.5 (8.91)
10.0	20.0 (508)	3.5 (8.91)
0.5	1.0 (25.4)	6 (15.24)
1.0	2.0 (50.8)	6 (15.24)
1.5	3.0 (76.2)	6 (15.24)
2.0	4.0 (101.6)	6 (15.24)
2.5	5.0 (127)	6 (15.24)
3.0	6.0 (152.4)	6 (15.24)
4.0	8.0 (203.2)	6 (15.24)
5.0	10.0 (254)	6 (15.24)
6.0	12.0 (304.8)	6 (15.24)
8.0	16.0 (406.4)	6 (15.24)
10.0	20.0 (508)	6 (15.24)
12.0	24.0 (609.6)	6 (15.24)
20.0	40.0 (1016)	6 (15.24)

Dimensions

approx. 2.5 x 1.5 cm (1 x 0.6 in),
length is 3.81 cm (1.5 in) greater than film width

Shipping Weight

0.7 kg (1.5 lbs)

Multiple Clearance Applicators

Multiple Clearance Applicators are designed for the production of uniform films of paints, adhesives and similar products on plane substrates. They combine the accuracy of fixed applicators with the versatility of multiple clearance / gap choices in one unit. These applicators are suitable for use of aqueous, acid, and alkaline products.

4-Sided Applicator

- Stainless steel – corrosion-resistant
- 4 clearances

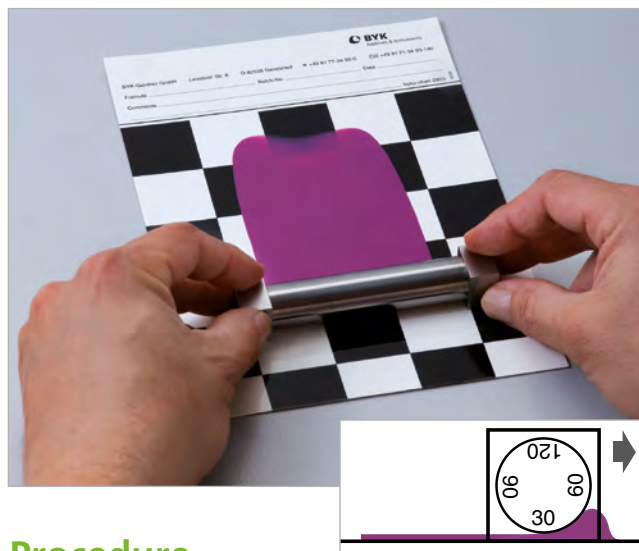

Procedure

- Place substrate to be coated on smooth surface
- Place film applicator with desired gap depth on substrate
- Pour coating in front of gap in pulling direction
- Pull at uniform speed (approx. 25 mm / s)
- Put applicator immediately into diluted cleaning solvent and clean with brush

How to choose the right applicator.

- Low viscous paint: applicator frame
- High viscous paint: 4-sided or bar applicator
- Flexible substrates like foils: wire wound applicators

Applicator Frame

- Stainless steel – corrosion resistant
- 4 clearances
- Packaged in a handy reuseable box to prevent damage
- 2057: 2-chamber design for assessing 2 paint formulations side by side



Standards

ASTM	D 823
FTMS	No. 141a, Meth. 2161, Meth. 2162, Meth. 4255, Meth. 6226



Ordering Information

Cat. No.	Description
2020	4-Sided Bar 60, 30-120 µm
2021	4-Sided Bar 80, 30-120 µm
2040	4-Sided Bar 60, 50-200 µm
2041	4-Sided Bar 80, 50-200 µm
2030	Applicator Frame 60, 30-120 µm
2031	Applicator Frame 80, 30-120 µm
2056	Applicator Frame 70, 50-200 µm
2057	Applicator Frame 2x35, 50-200 µm

Comes complete with:

Applicator
Reuseable storage case

*Note: 2-chamber design 35 mm length per chamber

Technical Specifications

Gap Clearance	Film Width	Material
30 & 60 & 90 & 120 µm	60 mm	Stainless Steel
30 & 60 & 90 & 120 µm	80 mm	Stainless Steel
50 & 100 & 150 & 200 µm	60 mm	Stainless Steel
50 & 100 & 150 & 200 µm	80 mm	Stainless Steel
30 & 60 & 90 & 120 µm	60 mm	Stainless Steel
30 & 60 & 90 & 120 µm	80 mm	Stainless Steel
50 & 100 & 150 & 200 µm	70 mm	Stainless Steel
50 & 100 & 150 & 200 µm	2 x 35 mm*	Stainless Steel

Multiple Clearance Applicators

Multiple Clearance Applicators combine the accuracy of fixed applicators with the versatility of multiple clearance / gap choices in one unit.

Bar Type

- 440C Stainless steel
- 2 clearances

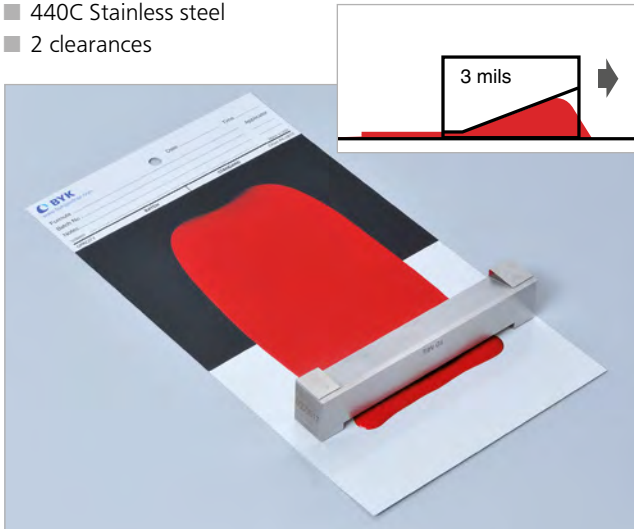

U Shaped

- 440C Stainless steel
- 2 clearances



Ordering Information

Cat. No.	Description
6957	Double Bar 2" – 2&4 mils
5302	Double Bar 2" – 6&10 mils
5303	Double Bar 3" – 2&4 mils
5304	Double Bar 3" – 6&10 mils
5305	Double Bar 4" – 2&4 mils
5306	Double Bar 4" – 6&10 mils
5307	Double Bar 5" – 2&4 mils
5308	Double Bar 5" – 6&10 mils
5309	Double Bar 6" – 2&4 mils
5310	Double Bar 6" – 6&10 mils
5326	U-Bar 2", 2&4 mils
5327	U-Bar 2", 6&10 mils
5328	U-Bar 3", 2&4 mils
5329	U-Bar 3", 6&10 mils
6948	U-Bar 4", 2 & 4 mils
5331	U-Bar 4", 6&10 mils
5332	U-Bar 5", 2&4 mils
5333	U-Bar 5", 6&10 mils
5334	U-Bar 6", 2&4 mils
5335	U-Bar 6", 6&10 mils

Comes complete with:

- Applicator bar
- Reuseable storage case

Technical Specifications

Gap Clearance µm (mils)	Film Width mm (inch)	Material
50.8 & 101.6 µm (2 & 4 mils)	50.8 mm (2 in)	Stainless Steel
152.4 & 254.0 µm (6 & 10 mils)	50.8 mm (2 in)	Stainless Steel
50.8 & 101.6 µm (2 & 4 mils)	76.2 mm (3 in)	Stainless Steel
152.4 & 254.0 µm (6 & 10 mils)	76.2 mm (3 in)	Stainless Steel
50.8 & 101.6 µm (2 & 4 mils)	101.6 mm (4 in)	Stainless Steel
152.4 & 254.0 µm (6 & 10 mils)	101.6 mm (4 in)	Stainless Steel
50.8 & 101.6 µm (2 & 4 mils)	127.0 mm (5 in)	Stainless Steel
152.4 & 254.0 µm (6 & 10 mils)	127.0 mm (5 in)	Stainless Steel
50.8 & 101.6 µm (2 & 4 mils)	152.4 mm (6 in)	Stainless Steel
152.4 & 254.0 µm (6 & 10 mils)	152.4 mm (6 in)	Stainless Steel
50.8 & 101.6 µm (2 & 4 mils)	38.1 mm (1.5 in)	Stainless Steel
152.4 & 254.0 µm (6 & 10 mils)	38.1 mm (1.5 in)	Stainless Steel
50.8 & 101.6 µm (2 & 4 mils)	63.5 mm (2.5 in)	Stainless Steel
152.4 & 254.0 µm (6 & 10 mils)	63.5 mm (2.5 in)	Stainless Steel
50.8 & 101.6 µm (2 & 4 mils)	88.9 mm (3.5 in)	Stainless Steel
152.4 & 254.0 µm (6 & 10 mils)	88.9 mm (3.5 in)	Stainless Steel
50.8 & 101.6 µm (2 & 4 mils)	114.3 mm (4.5 in)	Stainless Steel
152.4 & 254.0 µm (6 & 10 mils)	114.3 mm (4.5 in)	Stainless Steel
50.8 & 101.6 µm (2 & 4 mils)	139.7 mm (5.5 in)	Stainless Steel
152.4 & 254.0 µm (6 & 10 mils)	139.7 mm (5.5 in)	Stainless Steel

Multiple Clearance Square Applicator

Multiple Clearance Applicators combine the accuracy of fixed applicators with the versatility of multiple clearance/gap choices in one unit.

- Greatest versatility
- 8 clearances
- Highest quality stainless steel
- Packaged in a handy reuseable box to prevent damage



Ordering Information

Cat. No.	Description
5361	Square Frame 2", 1-8 mils
5351	Square Frame 2", 5-50 mils
5363	Square Frame 2", 0.5-6 mils
5353	Square Frame 3", 1-8 mils
5354	Square Frame 3", 5-50 mils
5355	Square Frame 3", 0.5-6 mils
5356	Square Frame 4", 1-8 mils
5357	Square Frame 4", 5-50 mils
5358	Square Frame 4", 0.5-6 mils

Technical Specifications

Gap Clearance μm (mils)	Film Width cm (inch)	Material
25.4, 50.8, 76.2, 101.6, 127.0, 152.4, 177.8, 203.2 μm (1,2,3,4,5,6,7,8 mils)	5.08 cm (2 in)	Stainless Steel
127, 254, 381, 508, 635, 762, 1016, 1270 μm (5,10,15,20,25,30,40,50 mils)	5.08 cm (2 in)	Stainless Steel
12.7, 25.4, 38.1, 50.8, 76.2, 101.6, 127.0, 152.4 μm (0.5,1,1.5,2,3,4,5,6 mils)	5.08 cm (2 in)	Stainless Steel
25.4, 50.8, 76.2, 101.6, 127.0, 152.4, 177.8, 203.2 μm (1,2,3,4,5,6,7,8 mils)	7.62 cm (3 in)	Stainless Steel
127, 254, 381, 508, 762, 1016, 1270 μm (5,10,15,20,25,30,40,50 mils)	7.62 cm (3 in)	Stainless Steel
12.7, 25.4, 38.1, 50.8, 76.2, 101.6, 127.0, 152.4 μm (0.5,1,1.5,2,3,4,5,6 mils)	7.62 cm (3 in)	Stainless Steel
25.4, 50.8, 76.2, 101.6, 127.0, 152.4, 177.8, 203.2 μm (1,2,3,4,5,6,7,8 mils)	10.16 cm (4 in)	Stainless Steel
127, 254, 381, 508, 762, 1016, 1270 μm (5,10,15,20,25,30,40,50 mils)	10.16 cm (4 in)	Stainless Steel
12.7, 25.4, 38.1, 50.8, 76.2, 101.6, 127.0, 152.4 μm (0.5,1,1.5,2,3,4,5,6 mils)	10.16 cm (4 in)	Stainless Steel

Comes complete with:

- Square frame
- Reuseable storage case

Film Casting Knife

The BYK-Gardner Film Casting Knife is an adjustable clearance film applicator. Its extended end plates confine the coating sample during drawdown. The micrometer adjusted gate allows clearance / gap settings from 0 to 150 mils in 1 mil increments. Metric versions produce clearances / gaps of 0 to 3800 microns in 10 micron increments.

The applicator consists of two end plates joined by a bridge and an adjustable blade below the bridge. Two micrometers extend through the bridge and contact the upper edge of the blade, allowing it to be adjusted upward or downward to control the gap and ultimately the film thickness. The blade and end plates are constructed of 6.4 mm (1/4 in) aluminum. The end plates effectively contain the sample pool during the drawdown process.

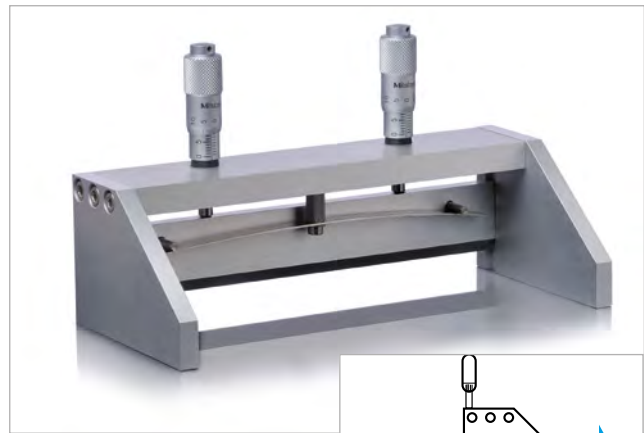

Most versatile manual model

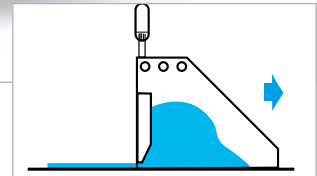

Standards

ASTM	D 823-53 (1970)
FTMS	No. 141a, Meth. 2161, 2162, 4255, 6266



Ordering Information

Cat. No.	Description
4301	Film Casting Knife 2"
4302	Film Casting Knife 4"
4303	Film Casting Knife 6"
4304	Film Casting Knife 8"
4305	Film Casting Knife 12"
2325	Film Casting Knife, 5 cm
2326	Film Casting Knife, 10 cm
2327	Film Casting Knife, 15 cm
2328	Film Casting Knife, 20 cm
2329	Film Casting Knife, 30 cm

Technical Specifications

Blade Width	Clearance/Gap	Dimensions	Weight
2 in	0-150 mils	76.2 x 102 x 63.5 mm (3 x 4 x 2.5 in)	0.5 kg (1.2 lbs)
4 in	0-150 mils	76.2 x 102 x 114 mm (3 x 4 x 4.5 in)	0.7 kg (1.6 lbs)
6 in	0-150 mils	76.2 x 102 x 165 mm (3 x 4 x 6.5 in)	0.8 kg (1.8 lbs)
8 in	0-150 mils	76.2 x 102 x 216 mm (3 x 4 x 8.5 in)	1.0 kg (2.1 lbs)
12 in	0-150 mils	76.2 x 102 x 317.5 mm (3 x 4 x 12.5 in)	1.2 kg (2.8 lbs)
5.1 cm	0-3800 µm	76.2 x 102 x 63.5 mm (3 x 4 x 2.5 in)	0.5 kg (1.2 lbs)
10.2 cm	0-3800 µm	76.2 x 102 x 114 mm (3 x 4 x 4.5 in)	0.7 kg (1.6 lbs)
15.2 cm	0-3800 µm	76.2 x 102 x 165 mm (3 x 4 x 6.5 in)	0.8 kg (1.8 lbs)
20.3 cm	0-3800 µm	76.2 x 102 x 216 mm (3 x 4 x 8.5 in)	1.0 kg (2.1 lbs)
30.5 cm	0-3800 µm	76.2 x 102 x 317.5 mm (3 x 4 x 12.5 in)	1.2 kg (2.8 lbs)

Comes complete with:

Film Casting Knife
Reuseable Storage case

Wire-wound rods

Wire-wound rods, 200 mm film width

Each rod has a 10 mm diameter with a 200 mm film width. There is a 20 mm space on both ends to grip the rod. The rods can be attached to a holder to secure the rod during a drawdown. An adapter is also available to attach the wire-wound rods to the 2101 Automatic Film Applicator.



Ordering Information

Cat. No.	Description
2419	Wire-wound rod 200 - 0.4 mils
2420	Wire-wound rod 200 - 0.6 mils
2421	Wire-wound rod 200 - 1 mils
2422	Wire-wound rod 200 - 2 mils
2423	Wire-wound rod 200 - 3 mils
2424	Wire-wound rod 200 - 4 mils
2425	Wire-wound rod 200 - 5 mils
2426	Wire-wound rod 200 - 6 mils
2428	Wire-wound rod 200 - 8 mils

Technical Specifications

Wet Film Thickness	Film Width	Dimensions
10 µm (0.4 mils)	200 mm (7.9 in)	24 cm x ø 1.0 cm (9.4 in x ø 0.4 in)
15 µm (0.6 mils)	200 mm (7.9 in)	24 cm x ø 1.0 cm (9.4 in x ø 0.4 in)
25 µm (1.0 mils)	200 mm (7.9 in)	24 cm x ø 1.0 cm (9.4 in x ø 0.4 in)
50 µm (2.0 mils)	200 mm (7.9 in)	24 cm x ø 1.0 cm (9.4 in x ø 0.4 in)
75 µm (3.0 mils)	200 mm (7.9 in)	24 cm x ø 1.0 cm (9.4 in x ø 0.4 in)
100 µm (3.9 mils)	200 mm (7.9 in)	24 cm x ø 1.0 cm (9.4 in x ø 0.4 in)
125 µm (4.9 mils)	200 mm (7.9 in)	24 cm x ø 1.0 cm (9.4 in x ø 0.4 in)
150 µm (5.9 mils)	200 mm (7.9 in)	24 cm x ø 1.0 cm (9.4 in x ø 0.4 in)
200 µm (7.9 mils)	200 mm (7.9 in)	24 cm x ø 1.0 cm (9.4 in x ø 0.4 in)



Ordering Information

Cat. No.	Description
2440	Wire-wound Rod Holder
2430	Wire-wound Rod Adapter*
4102	Wire-wound Rod Stand - 24 cm

Accessories

Information
for item numbers 2419 - 2428
for item numbers 2419 - 2428
for item numbers 2419 - 2428

*Note: Adapter lengthens the wire-wound rod to fit the 2101 and 2105 Automatic Film Applicator. Sold as a pair.

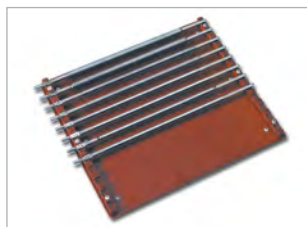

4102 - Rod Stand - 24 cm



2440 - Rod Holder

Wire-wound rods, 10" inch (254 mm) film width

Each rod is 1/2 inch in diameter and 12 inches in length, allowing 1 inch at either end to grip. The approximate wet film thickness that will result after a coating passes through the grooves between the wires and then levels off to a uniform thickness has been computed for each diameter of wire and is shown in the table below.



4101 Rod Stand - 10"

Standards

ASTM 4147



Ordering Information

Cat. No.	Description	Wet Film	Thickness	Wire	Diameter	Dimensions
		mils	microns	mils	mm	
4103	Wire-wound rod 10" – 0.2 mils	0.2	5	3	0.075	1.3 x 30.5 cm (0.5 x 12")
4104	Wire-wound rod 10" – 0.3 mils	0.3	8	4	0.10	1.3 x 30.5 cm (0.5 x 12")
4106	Wire-wound rod 10" – 0.4 mils	0.4	10	6	0.15	1.3 x 30.5 cm (0.5 x 12")
4108	Wire-wound rod 10" – 0.5 mils	0.5	13	8	0.20	1.3 x 30.5 cm (0.5 x 12")
4110	Wire-wound rod 10" – 0.65 mils	0.65	16	10	0.25	1.3 x 30.5 cm (0.5 x 12")
4112	Wire-wound rod 10" – 0.8 mils	0.8	20	12	0.30	1.3 x 30.5 cm (0.5 x 12")
4116	Wire-wound rod 10" – 1 mil	1.0	25	16	0.41	1.3 x 30.5 cm (0.5 x 12")
4122	Wire-wound rod 10" – 1.5 mils	1.5	38	22	0.56	1.3 x 30.5 cm (0.5 x 12")
4128	Wire-wound rod 10" – 2 mils	2.0	50	28	0.71	1.3 x 30.5 cm (0.5 x 12")
4134	Wire-wound rod 10" – 2.5 mils	2.5	63	34	0.86	1.3 x 30.5 cm (0.5 x 12")
4140	Wire-wound rod 10" – 3 mils	3.0	75	40	1.02	1.3 x 30.5 cm (0.5 x 12")
4152	Wire-wound rod 10" – 4 mils	4.0	100	52	1.32	1.3 x 30.5 cm (0.5 x 12")

Note: Additional rod sizes are available upon request.

A complete set of 12 wire-wound rods can be ordered. This will allow for a large range of wet film thickness capability from 0.2 mils (5 microns) to 4.0 mils (100 microns). A convenient bench stand comes with the set for easy handling and storage.



Ordering Information

Cat. No.	Description	Dimensions	Net Weight	Shipping Weight
		4100	Wire-wound rod set of 12	30.4 x 26.0 x 3.8 cm (12 x 10.25 x 1.5 in)
4101	Wire-wound rod Stand	29.5 x 26.0 x 2.8 cm (11.6 x 10.25 x 1.1 in)	0.4 kg (0.9 lbs)	0.9 kg (2 lbs)

Comes complete with:

Wire-wound rod set:
12 wire-wound rods
Bench stand

Step Gap Film Applicator

This applicator produces film thickness increasing step by step. Provides an easy comparison of opacity changes based on film thickness differences.

- 4 clearances with 4 steps each
- Film width is 25 mm per step

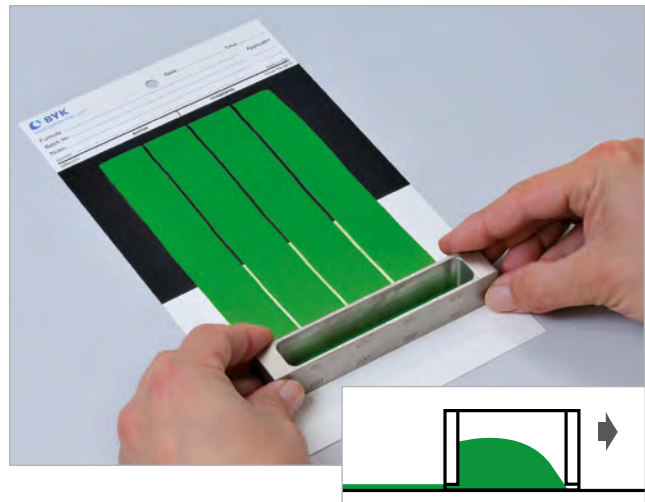

Ordering Information

Cat. No.	Description
2120	Step Gap Frame

Comes complete with:

Applicator Frame
Storage case

Technical Specifications

Gap Clearance (µm)	Film Width	Material
25 & 50 & 75 & 100 µm	4 x 25 mm	Stainless Steel
50 & 100 & 150 & 200 µm		
150 & 200 & 250 & 300 µm		
300 & 350 & 400 & 450 µm		

Dow Latex Film Applicator

A U-shaped film applicator designed to allow the application of a second coat of paint directly upon a hardened first coat while the ends of the applicator remain on the uncoated panel surface. The gap on one edge of the Dow Applicator has both greater clearance and width than the gap on the other edge.

Paint is applied within the channel formed by the "U" shape of the bar; as the bar is drawn down, the pool of paint is contained within the channel, yielding a consistent width.

- Allows two coats on a single substrate

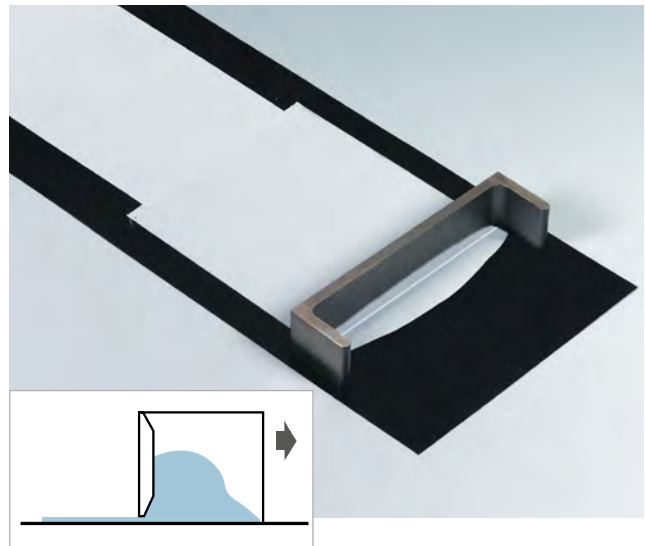

Standards

ASTM	D 823, D 2486, D 3258
Federal Spec.	TT-P



Ordering Information

Cat. No.	Description
2230	Dow Latex Applicator

Comes complete with:

Applicator
Storage case

Technical Specifications

Gap Clearance	Film Width	Material
178 and 254 µm (7 and 10 mil)	13.3 and 14 cm (5.25 and 5.5 in)	Stainless Steel

Leveling/Sagging Tester

In most cases, leveling is a desired property of paints expressed in the fact that the cured film shows a surface as plain as possible with brush marks, spray drops or other unevenness occurring as little as possible. Sagging, however, is considered a paint defect, particularly occurring on vertical surfaces, in edges and corners. The most common terms, for example streaks or tear drops, perfectly describe its characteristic appearance. It is not always possible, or only with difficulties, to measure this type of flow behavior by means of viscometers.

- Simple comparison test of the leveling and sagging properties of paints in the period between application and drying
- One applicator to test leveling and sagging
- Corrosion resistant stainless steel construction

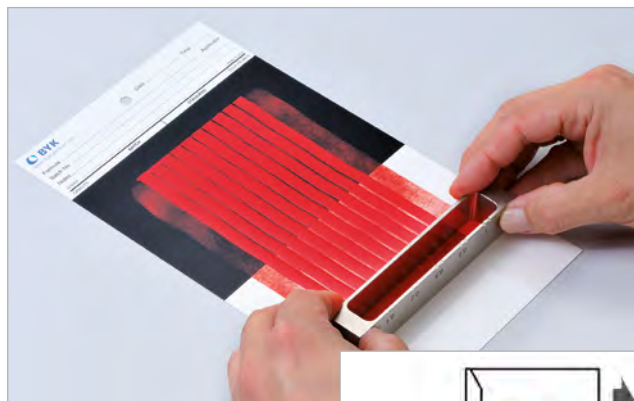

Standards

ASTM	D 2801
FTMS	141a, Method 4494



Leveling Test Procedure

- Draw the paint to be tested over a plane substrate (test chart), producing 5 pairs of streaks of various film thicknesses
- Hold the test panel in a horizontal position, and observe which of the pairs of streaks converge
- Generally, the gap depth of that pair of streaks is indicated, where the intervals between the streaks are slightly visible

Sagging Test Procedure

- Apply the coating, forming 10 streaks of various thicknesses
- Immediately after application, place the test panel into a vertical position, with the thinnest film streak at the top, avoiding any shock
- Depending on the sagging tendency the separate streaks converge
- For a reproduction of the results, which is difficult anyway, it is important to work under constant climatic conditions, to apply film streaks uniformly, and to set a time for evaluation



Ordering Information

Cat. No.	Description
0810	Leveling/Sagging Tester

Comes complete with:

Leveling/Sag Tester frame applicator
Storage case

5 pairs of gaps for leveling test: 0.1 0.2 0.3 0.5 1.0 mm

10 steps for sagging test: 75 100 125 150 175 200 225 250 275 300 µm

NYPC Leveling Test Blade

This instrument provides a means of evaluating the ability of a freshly applied coating to level before curing while reducing or eliminating marks caused by brushing or other means of application. Evaluations of leveling using this specially designed applicator correlate with, but are more consistent than, evaluations done by brushout. Since different factors influence leveling and sagging, tests for these properties should not be confused with each other. The leveling test is performed on a horizontal plane and is not a measure of sagging.

The New York Paint Club (NYPC) Leveling Test Blade is a U shaped film applicator with a shallow gap cut into one edge. Into this shallow gap is cut an evenly spaced series of five pairs of narrow notches having total clearances of 10, 20, 40, 80 and 160 mils. The applicator will produce a 4" wide drawdown, and has an overall width of 5".

A drawdown is made on a panel or chart using normal procedures. This produces five parallel pairs of ridges with a very thin (<0.5mil) distance between them. The drawdown is kept flat on a horizontal plane until the coating is dry and it is then evaluated. Leveling is rated on the basis of which ridge pairs of coating merged together and to what extent.

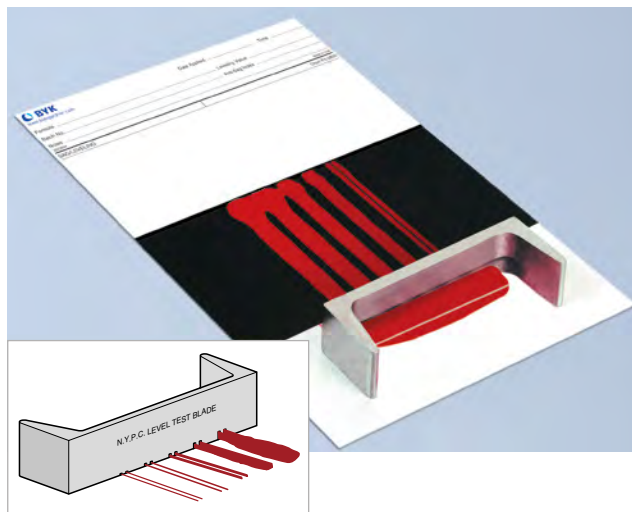

Complies with New York Society for Paint Technology

Standards

New York Society for Paint Technology Official Digest	No. 44, Vol. 32 No. 430, p. 1435
--	----------------------------------



Ordering Information

Cat. No.	Description
0812	NYPC Leveling Test Blade

Comes complete with:

Test blade
Storage case

Technical Specifications

Shipping Weight	Net Weight	Dimensions
450 g (1 lbs)	340 g (12 oz.)	127 x 32 x 44.5 mm (5 x 1.25 x 1.75 in)

Leveling Test Blade

The Leveling Test Blade is designed to comply with ASTM method D 4062 to measure the leveling properties of water and solvent-based architectural coatings. The leveling blade creates parallel ridges to simulate brush marks. After the coating dries the drawdown is compared to plastic leveling standards.

The leveling test bar is a cylinder rod with alternating gap clearances of 100 and 300 microns (4 and 12 mils). Plastic side arms are a guide to maintain a straight blade movement.



Standards

ASTM	D 4062
-------------	--------



Ordering Information

Cat. No.	Description
0813	Leveling Test Blade

Comes complete with:

Test blade
Storage case

Technical Specifications

Dimensions	Weight
185 x 100 x 25 mm (7.25 x 4.0 x 1.0 in.)	531 gm (1.2 lbs)

Anti-Sag Meter

Coatings applied on non-horizontal surfaces will sag due to gravity. Sag resistance is a factor of the composition and viscosity of the coating, as well as the applied thickness. The Anti-Sag meter allows quantification of the sagging properties of coatings.

- Quick test of the sagging of coatings on non-horizontal surfaces
- Available in most coating thickness ranges

The applicator is a U-shaped drawdown bar with a series of 1/4 inch (6.4 mm) wide notches of varying clearances, spaced 1/16 inch (1.6 mm) apart. The bar is 5 inches (127 mm) wide and produces a total film width of 3 3/8 inches (86 mm). When a drawdown is made, a series of parallel stripes of different wet film thickness will be formed. This panel is placed on a vertical surface with the stripes horizontal and the thickest stripe lowest. As the film stripes sag downward, some of the uncoated 1/16 inch (1.6 mm) spaces may become entirely covered. The clearance of the gap that produces the thickest film stripe, not sagging completely to the stripe below, is the anti-sag index of the coating.



Standards

ASTM D 3730. D 4400



Ordering Information

Cat. No.	Description
5401	Anti-Sag Meter 3-12 mils
5402	Anti-Sag Meter 1-6 mils
5403	Anti-Sag Meter 14-60 mils
5404	Anti-Sag Meter 4-24 mils

Comes complete with:

Anti-sag meter bar
Storage case

Technical Specifications

Clearance Range	Standard Range 76 to 305 μm (3 to 12 mils)
	Low clearance 25.4 to 152.4 μm (1 to 6 mils)
	High clearance 355.6 to 1524 μm (14 to 60 mils)
	Medium clearance 101.6 to 609.6 μm (4 to 24 mils)
Dimensions	12.7 x 3.8 x 2.5 cm (5 x 1.5 x 1 in)
Net Weight	0.3 kg (0.625 lbs)
Shipping Weight	0.6 kg (1.25 lbs)

Leslie Applicator

This applicator is used for flow/leveling and sag testing. The design is similar to the anti-sag meters with an extended gap range of 1 to 18 mils (25.4 - 457.2 microns). The 6 mil (152.4 microns) gap section is extended relative to the other gaps.



Ordering Information

Cat. No.	Description
5409	Leslie Applicator

Comes complete with:

Applicator
Storage case

Technical Specifications

Clearance Range	24.4 to 457.2 μm (1 to 18 mils)
Dimensions	17.8 x 5.56 x 2.54 cm (7.0 x 2.19 x 1.0 in)
Net Weight	0.8 kg (1.76 lbs)

Pfund Cryptometer

Wet Hiding Power Test

The cryptometer is a wedge type film applicator, which determines the wet hiding power of a coating within a few minutes.

- Quickly and reliably checks wet hiding power
- Determines thickness needed for complete hiding
- Gives estimate of coverage in square feet per gallon
- Can be used with any color of coating
- Small sample size (3 - 5 ml.) makes this ideal for QC tests

It consists of two plates of glass separated at a fixed angle. The bottom glass plate is engraved with a scale, and the top plate is transparent.

Procedure

A coating is placed into the open area between the plates, forming a wedge shaped film (Fig. 1). By sliding the top plate back and forth, a sharp line of demarcation alternatively appears and disappears (Fig. 2). The point at which the demarcation line appears is read on the engraved scale (Fig. 3). These scale readings are easily converted into thickness in mils, or coverage in square feet per gallon using the table furnished with the instrument.

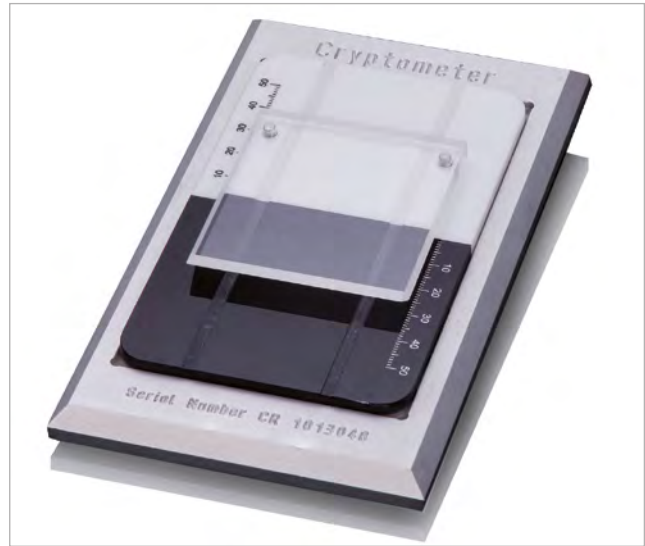

The value of the "wedge constant" of a top plate is the thickness in mils of the wedge of wet paint exactly over the demarcation line when the top plate is centered over this line and the scale reading is 25. Top plates with different wedge constants are included, depending on the opacity of the material to be tested:

- Wedge constant 0.007 for coatings with lesser opacity
- Wedge constant 0.002 for more opaque coatings



Ordering Information

Cat. No.	Description
3301	Pfund Cryptometer

Comes complete with:

Base Plate; Top Plate, wedge constant 0.002
Top Plate, wedge constant 0.007

Technical Specifications

Dimensions	Net Weight	Shipping Weight
16.5 x 10.1 x 3.8 cm (6.5 x 4 x 1.5 in)	1.2 kg (2.75 lbs)	1.8 kg (4 lbs)

Accessories: Extra Top Plates

Due to friction, top plates wear and should be replaced periodically.



(Fig. 1)



(Fig. 2)

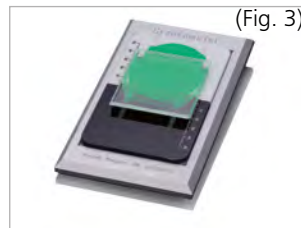

(Fig. 3)



Ordering Information

Cat. No.	Description
3302	Top plate 0.002
3303	Top plate 0.007
3304	Top plate 0.0035
3305	Bottom plate black / white

Accessories

Information
Wedge constant 0.002
Wedge constant 0.007
Wedge constant 0.0035
1/2 black and 1/2 white

Vacuum Pump

For use with vacuum plates, as well as other applications where a reliable source of low vacuum is needed. Compact and rotary in design, this pump provides a quiet and constant source of vacuum.

- Low maintenance design
- Rugged construction
- Carrying handle for easy transport
- Compact size for laboratory use

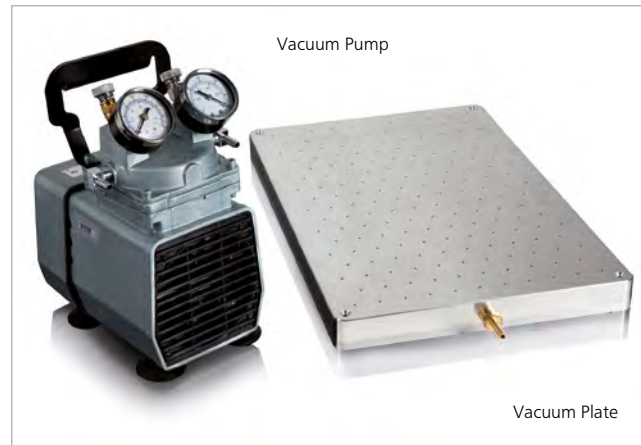

Ordering Information

Cat. No.	Description
3879	Vacuum Pump 115 V
3877	Vacuum Pump 230 V, with European Power Plug
3875	Vacuum Pump, 230V with UK Power Plug

Comes complete with:

Vacuum gage, Pressure gage, Regulator, Power cord with plug, Rubber feet, Flexible tube 1.5 m

Technical Specifications

Motor Power	Power Supply	Capacity	Dimensions	Net Weight
0.09 kW (0.125 hp)	115 V 60 Hz	1.9 m ³ /h (1.1 cfm)	193.6 x 130 x 272 mm (7.8 x 5.12 x 10.69 in)	7.3 kg (16.1 lbs)
0.09 kW (0.125 hp)	230 V 50 Hz	1.9 m ³ /h (1.1 cfm)	193.6 x 130 x 272 mm (7.8 x 5.12 x 10.69 in)	7.3 kg (16.1 lbs)
0.09 kW (0.125 hp)	230 V 50 Hz	1.9 m ³ /h (1.1 cfm)	193.6 x 130 x 272 mm (7.8 x 5.12 x 10.69 in)	7.3 kg (16.1 lbs)

Vacuum Plates

Also known as suction plates, these perforated metal plates are ideal for most manual drawdowns.

- Holds charts securely during drawdowns
- Helps to achieve uniform results
- Uniform flatness across the entire surface

Consists of a perforated machined aluminum or stainless steel to which a vacuum is applied to hold the drawdown card in place. The card should be slightly flexible and stiff enough to resist dimpling.

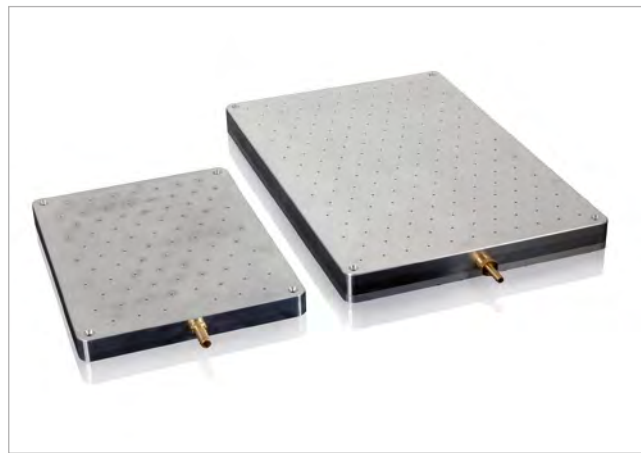

Ordering Information

Cat. No.	Description
3876	Vacuum Plate S, aluminum
3878	Vacuum Plate L, aluminum
3882	Vacuum Plate S, stainless steel

Comes complete with:

Vacuum plate
Hose fitting
Rubber footings

Technical Specifications

Surface Size	Dimensions	Net Weight	Shipping Weight
229 x 305 mm (9 x 12 in)	229 x 305 x 32 mm (9 x 12 x 1.25 in)	2.7 kg (6 lbs)	5 kg (11 lbs)
305 x 457 mm (12 x 18 in)	305 x 457 x 32 mm (12 x 18 x 1.25 in)	7.2 kg (16 lbs)	10 kg (22 lbs)
229 x 305 mm (9 x 12 in)	229 x 305 x 32 mm (9 x 12 x 1.25 in)	9.0 kg (20 lbs)	12 kg (26.4 lbs)

Flatness tolerance: ≤ 25.4 microns (1.0 mils) of entire plate surface

byko-drive

Automatic Film Applicator

The byko-drive Automatic Applicator is an economical film applicator that improves the consistency of drawdowns. When more than one operator is drawing down the same coating or ink, the dry film appearance will vary because of different drawdown techniques. Drawdown speed and pressure on the applicator tool will impact the result. Film thickness, gloss, opacity, and color can vary with differing drawdown techniques.

The byko-drive is available with a vacuum plate or glass plate with clamp. Applicator bars, U-shaped bars, applicator frames, film casting knives, and wire-wound rods are acceptable applicators. The byko-drive has a compact design consisting of a light-weight aluminum chassis and impact resistant thermo-plastic cover.

- User selectable start and stop positions to accommodate different chart sizes
- Power assist carriage return for ease of operation
- Drip pan for faster cleanup
- Weight and bar fixture for consistent pressure on applicator devices
- Small footprint to save on counter space
- Easy to operate user controls
- Adjustable push bar gap clearances

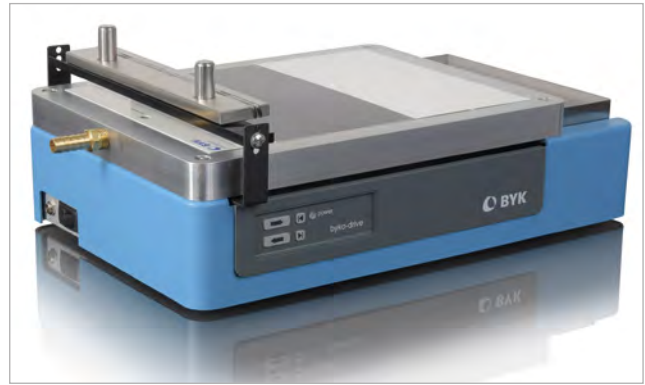

2121 byko-drive V Automatic Film Applicator

Standards

ASTM D 823, D 4147

The byko-drive has two user selectable speeds:

- 10 mm/sec - complies with ISO method 11998
- 1 in/sec - same speed setting as the BYK-Gardner Mechanical Drive



Ordering Information

Cat. No.	Description
2121	byko-drive V
2122	byko-drive G

Comes complete with:

byko-drive
Weight bar (2123)
External power supply
Drip pan
Instruction manual

Note: Applicators and Vacuum Pump must be ordered separately.

Accessories

Cat. No.	Description
3879	Vacuum Pump, 115V
3877	Vacuum Pump, 230V, European plug
3875	Vacuum Pump, 230V, UK Plug
3876	Vacuum Plate S
2129	Weight Bar, 1,362 gm (3.0 lbs)
2123	Weight Bar, 454 gm (1.0 lb)
2128	Weight Bar, 908 gm (2.0 lbs)
2124	Power supply, for byko-drive
2125	Drip pan
2127	Glass plate + clamp
2126	O-ring Set (10 pcs)
2130	Long Push Arm, pair, Adjustable gap

Technical Specifications

Platform	
with vacuum plate	
with glass plate and clamp	
Voltage	100 - 240 V/50 - 60 Hz
Traverse speeds	10 mm/sec or 1 in/sec
Traverse speed accuracy	±5%
Wire bar diameter limits	6 - 19 mm (0.25 - 0.75 in)
Wire bar length maximum	406 mm (16 in)
Stroke length	25 - 235 mm (1 - 9.25 in)
Weight	6 kg (13 lbs)
Test panel size maximum	229 x 305 mm (9 x 12 in)
Dimensions	365 x 229 x 127 mm (14.38 x 9 x 5 in)
Gap between push-bar and plate	3.7 mm, 10.0 mm, 16.4 mm

byko-drive XL

New!

Automatic Film Applicator

The byko-drive XL Automatic Film Applicator has the most flexible design to perform drawdowns of coatings and inks. The dry film appearance is impacted by drawdown speed and pressure on the applicator tool. A programmable speed control from 5 - 500 mm/sec. in 1 mm/sec. increments is standard. Interchangeable weights apply pressure across the entire length of the applicator for a consistent film thickness. The push bar is designed to accommodate a wide variation in wire-rod sizes, applicator bars, applicator frames, and film casting knives. The touchscreen display makes it easy to program the operating parameters: traverse speed, start position, and stroke length. There are six memory locations to save routine settings.

The byko-drive XL has a vacuum plate and glass plate platform versions. The vacuum plate and glass plates are user interchangeable for labs that need both platforms.

- Programmable speeds from 5 – 500 mm/second
- Adjustable push-bar gap clearance for thicker substrates or large height applicators
- Built in vacuum pump with 2 zone vacuum plate (for 2131)
- User definable start position and stroke length to accommodate all drawdown chart sizes
- Weight bar options to change the downward force onto the applicator
- Two year warranty
- CE/UL/CSA certified

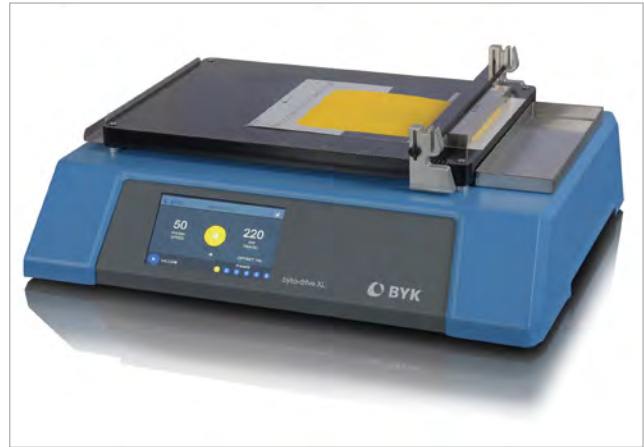

byko-drive XL, Vacuum plate version

Standards

ASTM	D 823, D 4147
ISO	11998

- 8 selectable languages: English, German, French, Spanish, Italian, Portuguese, Chinese, Japanese
- Metric and English unit scales engraved on vacuum plate to easily set start position and stroke length
- Convenient applicator storage shelf
- Switchable between metric and English units
- Vacuum plate can be used with an external vacuum source
- Light weight design
- Can accommodate virtually all applicators and wire-wound rods without additional hardware
- Drip pan for easy clean-up

Technical Specifications

Traverse Speed	5 - 500 mm/s (0.2 - 19.6 in/s)
Traverse Speed Accuracy	1% of set speed
Speed Display Resolution	1 mm/s (0.10 in/s)
Wire Bar Diameter Maximum	15 mm (0.6 in)
Wire Bar Length Maximum	600 mm (24 in)
Test Panel Size Maximum	285x438 mm (11.2x 17.2 in)
Stroke Length Maximum	400 mm (15.7 in)
Set-up Memory	6
Gap Clearance between push-bar & plate	2 - 39 mm (0.08 - 1.54 in)
Push-bar Weight	500 grams (up to 1500 grams with optional weights)
Maximum vacuum (2131 only)	0.67 bar (20 inHg)
Vacuum Zones	2
Voltage	100 - 240VAC/50-60 Hz
Dimensions	610x445x204 mm (24.0x17.5x8.0 in)
Weight	17 kg (37.4 lb)

Ordering Information

Cat. No.	Description
2131	byko-drive XL, V with vacuum plate
2132	byko-drive XL, G with glass plate

Comes complete with:

byko-drive XL, Weight bar (2135), External power supply, Drip pan, Short instructions, 2-year warranty

Accessoires

Cat. No.	Description
2133	Vacuum Plate, XL
2134	Glass Plate, XL
2135	Push-bar weight, 500 grams
2136	Push-bar weight, 1000 grams
2137	Drip Pan, XL
2138	Screen Protector





Space – the Final Frontier!

BYK-Gardner's spectro-guide to orbit the earth

NASA has launched two BYK-Gardner spectro-guide spectrophotometers to the International Space Station (ISS) aboard Orbital Vehicle 103 (Shuttle Discovery).

One critical aspect of spacecraft crew health assurance is maintaining a safe, useable supply of drinking water. To ensure that water provided by the spacecraft distribution and recycling systems is potable, bacterial inhibitors are added. Therefore, the spectro-guides are used as an integral part of an experimental water quality monitoring system developed by a team of scientists and engineers from NASA's Habitability and Environmental Factors Division in the Space Life Sciences Directorate at Johnson Space Center, the Wyle Integrated Science and Engineering Group in Houston, Texas, the University of Utah, and Iowa State University. The system is called the Colorimetric Water Quality Monitoring Kit (CWQMK), and it uses color measurements to help ensure that only the appropriate biocide levels are present in the water on ISS. Before, all samples used to monitor spacecraft water quality were collected in-flight and stored until returned to earth for chemical analysis. Not ideal because of sample degradation during storage and the time lapse between sampling and correction steps in real time – if needed.

As part of pre-deployment procedures, the spectro-guide had to pass a Procedure Validation (PV) session with NASA's astronaut

corps. The PV session allows an astronaut to run through the onorbit procedures to make sure that there won't be any confusion during crew training or during deployment on the ISS. Due to the simplicity and ease of operation of the spectro-guide, there were no issues during the PV session. Subsequently, operational procedures were approved and seven astronauts were trained on the hardware.

The spectro-guides that are used on the ISS are virtually the same as those used by thousands of color measurement professionals on earth. They feature advanced patented technology that make them the most accurate, reliable, and dependable color spectrophotometers available:

- › Temperature independent readings – the same results at 15 °C or 38 °C are guaranteed
- › Long-term stable LED illumination – no bulbs to burn out
- › Calibration suggested only every 3 months – not every hour
- › No warm up period needed
- › Highly accurate, repeatable readings through robotic calibration during manufacturing
- › Virtually never needs service due to advanced design

spectro-guide and the Discovery – a strong team to go where no color spectrophotometer has gone before!

Introduction

Laboratory Balances

Balances are one of the most universal laboratory instruments used in virtually every lab in the world today. BYK-Gardner offers the Sartorius balances to further enhance our ability to provide a “total solution” for the coatings and plastic laboratory market. These balances will meet the needs of virtually any lab, from routine QC checks to sophisticated R&D tasks.

The Sartorius brand provides world class performance with a durable, rugged design. BYK-Gardner offers two Sartorius balances series. The Entris Series that are affordable analytical and toploading balances. The Quintix Series incorporates the latest features of balance design. The product offering includes analytical balances for the most critical weighting tasks and the easy to use toploading design.

When selecting a balance the capacity and the readability are the two most important specifications. The capacity is the maximum limit of the balance. The readability is the minimum unit value that can be displayed. The pan size is another feature that should be considered.



BALANCES

Appearance

Color

Balances

Technical Service

Index

Sartorius Balances

Entris Analytical Balances

The Entris series from Sartorius offers excellent performance for even the most demanding users. They meet all requirements for efficient workflow and accurate results needed in many of today's laboratory applications.

All Entris models are made with state-of-art technology to provide accurate and outstanding performance at remarkably affordable prices. Entris balances are distinguished by an attractive design, durable ABS housing and user-friendly operation.

- Advanced microprocessor for accurate weighing results and fast stabilization
- Built-in application programs for weighing, percentage, density determination, counting, conversion
- Backlit display
- Pan size 90 mm (3,5 inch)
- Anti-theft lock for cable or chain
- Durable ABS housing
- Integrated under-floor weighing
- RS232C interface
- External calibration
- 2 year warranty



Ordering Information

Cat. No.	Description
1636	Entris 124-15
1637	Entris 224-15

Comes complete with:

Balance,
Draft shield,
Anti-theft lock,
Below balance weighing,
Glass level

Technical Specifications

Readability	Capacity	Repeatability
0.0001 g	120 g	0.0001 g
0.0001 g	220 g	0.0001 g
Voltage	100-240V, 50-60Hz, 0.2A	
Net Weight, approx.	4.4 kg (9.7 lb)	
Dimensions (DxWxH)	230 x 303 x 330 mm (9.1 x 11.9 x 13.0 in)	

Sartorius Balances

Entris Toploading Balances

The performance specifications of the Sartorius Entris series of balances set new standards in the compact and affordable laboratory balances market. Whether you need to weigh in a lab or in the field, with a Sartorius Entris series balance you will always have just the right equipment.

- Easy navigation with function keys and simple to read level indicators
- Built-in application programs: Weighing, percentage, density determination, counting, conversion
- Backlit Display
- Battery-operable with battery pack accessory
- Extra large feet for easy leveling
- Anti-theft lock protection
- RS 232 C interface
- Draft Shield for 323-1S and 623-1S models



Ordering Information

Cat. No.	Description
1638	Entris 323-1S
1639	Entris 623-1S
1640	Entris 2202-1S
1641	Entris 6202-1S
1642	Entris 8201-1S

Comes complete with:

Balance,
Glass level,
Anti-theft lock,
Below balance weighing

Technical Specifications

Readability	Capacity	Repeatability	Pan Size
0.001 g	320 g	0.001 g	115 mm ø
0.001 g	620 g	0.001 g	115 mm ø
0.01 g	2200 g	0.01 g	180 x 180 mm
0.01 g	6200 g	0.01 g	180 x 180 mm
0.1 g	8200 g	0.1 g	180 x 180 mm
Voltage		100-240V, 50-60Hz, 0.2A	
Net Weight, approx.		4.9 kg (10.8 lb)	
Dimensions (DxWxH)		For part numbers 1638, 1639: 230 x 303 x 136 mm 9.1 x 11.9 x 5.4 in.	
		For part numbers 1640 - 1642: 230 x 303 x 91 mm 9.1 x 11.9 x 3.6 in.	

Accessories

Cat. No.	Description
1607	Printer
1643	Printer paper, for 1607
1609	Dust Cover, for Analytical Balance
1038	Data Cable RS232C/USB

Balances Sartorius

Sartorius Quintix Series

The Quintix series of balances set new standards for design and performance. The Quintix Series provide a wide range of analytical and toploading solutions combining innovative design and highly advanced weighing technology. With the input from experienced lab users a new operating interface was developed. Self-explanatory icons and plain-text prompts on a large touch screen display have all the information for easy operation.

- Easy-to-run application programs at the touch of a button: %weighing, density, mass unit conversion, counting, statistics and more
- Checkweighing to determine if a sample is within the tolerance range
- Convenient filling mode for reliable filling to target value
- isoCAL function to automatically compensate for drift caused by temperature fluctuations
- Menu lock for protection against unintentional changes
- Chemically and vibration resistant housing
- Below balance weighing feature
- USB interface with direct connectivity with Microsoft® Office program. No additional software is needed.
- GLP/GMP compliant records

Sartorius Quintix Analytical Balances

- Draft shield with removable side panels
- Easy to clean design
- Resolution down to 0.1 mg



Ordering Information

Cat. No.	Description
1026	Quintix 124-1S
1027	Quintix 224-1S

Comes complete with:

Balance
In use cover, Anti-theft lock
Below balance weighing
Draft shield

Technical Specifications

Readability	Capacity	Reproducibility	Pan Size
0.0001 g	120 g	0.0001 g	90 mm (3.54 in)
0.0001 g	220 g	0.0001 g	90 mm (3.54 in)
Voltage	100-240V, 50-60 Hz, 0.2A		
Net Weight, approx.	5.2 kg (11.4 lb)		
Dimensions (DxWxH)	360x216x320 mm (14.1x8.5x12.6 in.)		

Sartorius Balances

Quintix Toploading Balances

- isoCAL feature – fully automatic temperature and time controlled adjustment
- Weigh cell mounted on heavy-duty die-cast plate made of aluminum alloy
- Anti-theft device – Kensington lock and lug for attaching a chain or cable
- Draft shield standard for models 213, 313 and 513



Ordering Information

Cat. No.	Description
1028	Quintix 213-1S
1029	Quintix 313-1S
1030	Quintix 513-1S
1031	Quintix 612-1S
1032	Quintix 1102-1S
1033	Quintix 2102-1S
1034	Quintix 3102-1S
1035	Quintix 5102-1S
1036	Quintix 5101-1S
1037	Quintix 5100-1S

Comes complete with:

Balance
In use cover, Anti-theft lock
Below balance weighing
Draft shield (for Quintix 213-1S, 313-1S, 513-1S only)

Accessories

Cat. No.	Description
1607	Printer
1643	Printer Paper, for Printer 1607
1608	Data Cable, USB/USB-A
1609	Dust Cover, Analytical Balances with draft shield

Technical Specifications

Readability	Capacity	Reproducibility	Pan Size Diameter
0.001 g	210 g	0.001 g	120 mm
0.001 g	310 g	0.001 g	120 mm
0.001 g	510 g	0.001 g	120 mm
0.01 g	610 g	0.01 g	180 mm
0.01 g	1100 g	0.01 g	180 mm
0.01 g	2100 g	0.01 g	180 mm
0.01 g	3100 g	0.01 g	180 mm
0.01 g	5100 g	0.01 g	180 mm
0.1 g	5100 g	0.1 g	180 mm
1.0 g	5100 g	0.5 g	180 mm
Voltage	100-240V, 50/60Hz, 0.2A		
New Weight, approx.	5.2 kg (11.4 lb.)		
Dimensions (DxWxH)	For models 213, 313, 513: 360x216x320 mm (14.1x8.5x12.6 in.) For models 612, 2102, 3102, 5102, 5101, 5100: 360x216x95 mm (14.1x8.5x3.75 in.)		



Touch the color with our new spectro2guide:

There it is in black and white: The new spectro2guide has arrived. The revolution in color management.



Upfront design. Color touchscreen. Camera preview. Auto calibration. Gloss. Fluorescence. Digital standard...

www.touchthecolor.com

BYK LC 2

Conductivity Meter

Provides measurement of electrical conductivity of solvents and solvent borne paint formulations for electrostatic spray applications.

- Stainless steel measuring cell and electrodes
- Solvent resistant housing

When measuring conductivity, liquid builds up a specific ohmic resistance to the electric current, depending on the applied voltage. The reciprocal value is the conductivity. The measured resistance depends on the geometric arrangement of the electrodes within the measuring cell. In order to be independent of the measuring cell, the measured resistance has to be divided by the cell constant "C" which yields specific resistance. The specific resistance describes the application and performance properties of electrocoating paints.

The BYK-Gardner LC 2 Conductivity Meter was developed in cooperation with the VDA (Association of German Automotive Industry) following VDA standards.

Measurement of the resistance of liquid paints is carried out in the annular passage of the measuring cell. The measuring cell consists of two separable parts. The electrodes are arranged concentrically (Cat. No.1710) or parallel (Cat. No.1712), thus forming an annular passage. They are insulated from each other.

The electrodes of the measuring cell are made of stainless steel, with the surface polished and therefore easy to clean. Only an absolutely clean measuring cell guarantees that the entire surface of the electrode is available for measurement. The probe is impervious and can be immersed in solvents for a short time.



Standards

ASTM	D 5682
DIN	55667
ISO	15091

Info!

The BYK LC 2 works only with solvents and solvent based paints. The presence of water will cause electrolysis and results in false readings.



Ordering Information

Cat. No.	Description
1722	Conductivity Meter LC 2
1710	Conductivity tube cell, LC 2
1712	Conductivity plate cell, LC 2
1713	Space holder for 1712

Note: BYK LC 2 Meter and measuring cell must be ordered separately. Please order 1713 space holders when ordering the 1712 measuring cell. The space holders are necessary to maintain the proper distance between the plates.

Technical Specifications

Measuring Range		Measuring Voltage	Power Supply	Dimensions	
50 kΩ - 19.99 MΩ, 20 μS - 0.05 μS		8 V (AC/DC)	9 V battery	105 x 55 x 145 mm (4.1 x 2.2 x 5.7 in)	
Diameter	Width	Cell Length	Cell	Qty/Box	
42 mm (1.6 in)		250 mm (9.8 in)	7.55 x 10 ⁻³ cm ⁻¹		
	50 mm (1.9 in)	380 mm (14.5 in)	7.55 x 10 ⁻³ cm ⁻¹		
				Constant C	
				100	



Very easy to clean – Plate Cell

Density Cups

Density is defined as weight per unit volume at a specified temperature. Density cups are used for quality control because errors in paint composition will result in different density readings. Density cups have also been described as liquid pycnometers.

BYK-Gardner Density cups use a cylindrical shape which provides a large opening for easy filling, emptying, and cleaning. The tightly fitted stainless steel covers have an upward slope to a small hole in the center to allow excess sample material to be expelled without entrapping air bubbles, which increases accuracy.



Made of corrosion resistant steel

ASTM Cup Volume

In North America the term “weight per gallon” (wpg) is used in the coating industry. The volume of the weight per gallon cup is such that, at a specified temperature, the numerical value in grams of water that it can hold is equal to, or ten times greater than, the numerical value in pounds of water that a gallon container can hold. A US gallon of water weighs 8.32 pounds, thus a Regular US weight per gallon cup holds ten times this amount in volume, 83.2 ml. When taking a measurement, the cup and the sample must be brought to the same equilibrium temperature (usually 25 °C or 77 °F). Regular and Imperial Cup tolerance are 0.5%; the Midget Cup tolerance is 1.2% measured at 25 °C with distilled water.

ISO Cup Volume

ISO Cups are machined from stainless steel, and use the metric system. The cups hold a defined volume of liquid of 50 or 100 ml. A tolerance of 0.1% is guaranteed. Testing is carried out in accordance with ISO at 23 °C ± 2 °C.

Standards

ASTM	D 333, D 1475, D 2805
BS	3900 A 19
DIN	53217
ISO	2811

Procedure

- Weigh cleaned density cup empty and record weight
- Temper density cup and test liquid (Refer to appropriate test standard for proper temperature)
- Fill density cup
- Put cover on without tilting
- Avoid air bubbles
- Remove overflowing liquid carefully with absorbent cloth
- Weigh filled density cup
- Calculate density



Determination of Density and Specific Gravity

	Volume (ml)	Density	Specific Gravity (relative to water)
U.S. Standard Cup	83.2	$[\text{weight full (g)} - \text{weight empty (g)}] \times 0.1 = \text{lbs/gal}$	$[\text{weight full (g)} - \text{weight empty (g)}] \times 0.01202 = \text{specific gravity}$
U.S. (Baltimore) Midget Cup	8.32	$[\text{weight full (g)} - \text{weight empty (g)}] = \text{lbs/gal}$	$[\text{weight full (g)} - \text{weight empty (g)}] \times 0.1202 = \text{specific gravity}$
ISO Cup	100 or 50	$[\text{weight full (g)} - \text{weight empty (g)}] / \text{volume (ml)} = \text{g/cm}^3$	specific gravity = density
British imperial Cup	100	$[\text{weight full (g)} - \text{weight empty (g)}] / \text{volume (ml)} = \text{g/cm}^3$	specific gravity = density

1 ml = 1 cm³; 1 liter = 1000 ml; specific gravity of water = 1 g/ml
 1000 ml = 0.2646 U.S. gallon; 1 U.S. gallon = 3.785 liter

Density Cups

BYK-Gardner offers four different sized density cups:

- Regular US Cup with a volume of 83.2 ml
- Midget cup with a volume of 8.32 ml. The Midget cup offers a direct conversion to lbs/gal, eliminating the need for dividing the full cup weight by 10.
- British Imperial Standard size with a volume of 100 ml.
- ISO standard size with a volume of 100 ml and 50 ml.

All the BYK-Gardner Density Cups com uncertified except for the ISO Cups with part numbers 1130 and 1140. Certification is available for a fee. The certification is provided by BYK-Gardner's ISO 17025 accredited service departments. Please contact your BYK-Gardner representative for pricing.



ISO Density Cups



Ordering Information

Cat. No.	Description
9654	US Density Cup
9655	US Density Cup w/tare weight
9665	US Midget Cup
9664	US Midget Cup w/tare weight
9658	BSI Density Cup
9659	BSI Density Cup w/tare weight
1132	ISO Cup L
1130	ISO Cup L certified
1142	ISO Cup S
1140	ISO Cup S certified

Technical Specifications

Volume ml	Dimensions	Shipping Weight
83.2	38 x 76 mm (1.5 x 3 in)	0.23 kg (0.5 lbs)
83.2	38 x 76 mm (1.5 x 3 in)	0.45 kg (1 lbs)
8.32	25 x 32 mm (1.0 x 1.25 in)	0.15 kg (0.33 lbs)
8.32	25 x 32 mm (1.0 x 1.25 in)	0.23 kg (0.5 lbs)
100	38 x 89 mm (1.5 x 3.5 in)	0.23 kg (0.5 lbs)
100	38 x 89 mm (1.5 x 3.5 in)	0.45 kg (1 lbs)
100	52 x 62 mm (2.05 x 2.44 in)	0.45 kg (1 lbs)
100	52 x 62 mm (2.05 x 2.44 in)	0.45 kg (1 lbs)
50	52 x 34 mm (2.05 x 1.34 in)	0.23 kg (0.5 lbs)
50	52 x 34 mm (2.05 x 1.34 in)	0.23 kg (0.5 lbs)

Fineness of Grind Gages

Also called grind gages and Hegman gages. Many types of solid materials must be ground or milled into finer particles for dispersion in appropriate liquid vehicles. The physical properties of the resulting dispersions, often called "grinds", depend not only on the actual size of the individual particles, but also on the degree to which they are dispersed.

The Fineness of Grind Gage is used to indicate the fineness of grind or the presence of coarse particles or agglomerates in a dispersion. It does not determine particle size or particle size distribution.

Grind gages are used in controlling the production, storage, and application of dispersion products produced by milling in the paint, plastic, pigment, printing ink, paper, ceramic, pharmaceutical, food, and many other industries.

The Fineness of Grind Gage is a flat steel block in the surface of which are two flat-bottomed grooves varying uniformly in depth from a maximum at one end of the block to zero near the other end. Groove depth is graduated on the block according to one or more scales used for measuring particle size.

Most gages will have one scale marked in either mils or microns.

- 1 mil = 25.4 microns
- 1 mil = 0.001 inch
- 1 micron = 0.001 mm

Wedge Printing Plates

The Wedge Printing Plate offers a convenient quality check for ink prior to use on the press. The ink can be evaluated for color, gloss, holdout, varnishability, drying time, rub and fade resistance. The printing gage consists of a precisely made channel of a fixed depth to control the ink film thickness. The channel has a large surface area to evaluate ink properties. The ink is precisely hand-drawn using a scraper. The plate is easy to clean for quick turnaround.

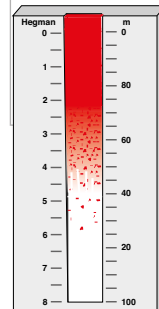
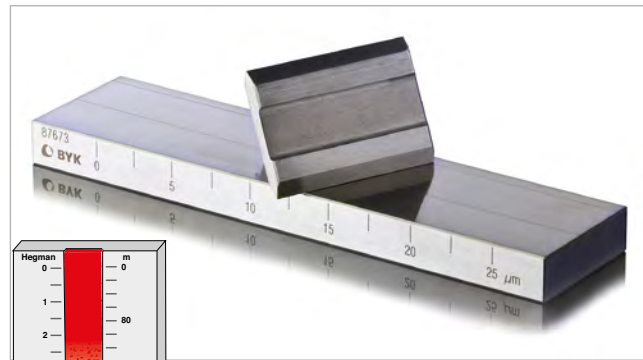

Made of corrosion resistant stainless steel

Standards

ASTM	D 333, D 1210, D 1316, D 6846
ISO	1524
FTMS	141a, Method 4411.1

The Hegman scale or National Standard scale may be abbreviated "NS" on the gage. The scale ranges from 0 to 8 with numbers increasing as the particle size decreases.

0 Hegman = 4 mil/100 micron particle size

4 Hegman = 2 mil/50 micron particle size

8 Hegman = 0 mil/0 micorn particle size

BYK-Gardner offers a wide variety of grind gages varying in scales, number or grooves, length and width of grooves and size of the block.



Standards

ASTM	D 6073, D 6846
-------------	----------------

Accessories

for Grindometers 1509 - 1512

for Grind Gages 2500 - 2517

for Wedge Printing Plates



Ordering Information

Cat. No.	Description
1518	Replacement Scraper, 50 mm
2514	Replacement Scraper, 95 mm
1522	Replacement Scraper, 117 mm

Fineness of Grind Gages



Ordering Information

Technical Specifications

Cat. No.	Description	Path Size	No. Of Paths	Scales	Range	Dimensions	Net Weight
1509	Grindometer 15*	13 x 130 mm	2	Micron	0 - 15	169 x 42 x 13 mm	1 kg
				Hegman	8 - 6.8		(2.2 lbs)
1510	Grindometer 25*	13 x 130 mm	2	Micron	0 - 25	169 x 42 x 13 mm	1 kg
				Hegman	8 - 6		(2.2 lbs)
1511	Grindometer 50*	13 x 130 mm	2	Micron	0 - 50	169 x 42 x 13 mm	1 kg
				Hegman	8 - 4		(2.2 lbs)
1512	Grindometer 100*	13 x 130 mm	2	Micron	0-100	169 x 42 x 13 mm	1 kg
				Hegman	8 - 0		(2.2 lbs)
2500	Grind Gage No. 25	0.5 x 2 in	2	Hegman	8 - 0	0.5 x 2.5 x 4.80 in	0.9 kg
				Mils	0 - 5		(2.0 lbs)
2501	Grind Gage No. 45	0.5 x 4 in	2	Hegman	8 - 0	0.5 x 2.5 x 6.69 in	1.6 kg
				Mils	0 - 5		(3.5 lbs)
2502	Grind Gage No. 65	0.5 x 6 in	2	Hegman	8 - 0	0.5 x 2.5 x 8 in	1.8 kg
				Mils	0 - 5		(4.0 lbs)
2503	Grind Gage No. 5251	0.5 x 5 in	2	Microns	0 - 25	0.5 x 2.5 x 6.69 in	1.8 kg
				Mils	0 - 1		(4.0 lbs)
				Hegman	8 - 6		
2504	Grind Gage No. 5252	0.5 x 5 in	2	Microns	0 - 50	0.5 x 2.5 x 6.69 in	1.8 kg
				Mils	0 - 2		(4.0 lbs)
				Hegman	8 - 4		
2505	Grind Gage No. 5254	0.5 x 5 in	2	Microns	0-100	0.5 x 2.5 x 6.69 in	1.8 kg
				Mils	0 - 4		(4.0 lbs)
				Hegman	8 - 0		
2506	Grind Gage No. 54	2 x 5 in	1	Hegman	8 - 0	0.50 x 3.5 x 6.75 in	3.6 kg
				Microns	0-100		(8.0 lbs)
2507	Grind Gage No. 52	2 x 5 in	1	Hegman	8 - 4	0.50 x 3.5 x 6.75 in	3.6 kg
				Microns	0 - 50		(8.0 lbs)
2508	Grind Gage No. 51	2 x 5 in	1	Hegman	8 - 6	0.50 x 3.5 x 6.75 in	3.6 kg
				Microns	0 - 25		(8.0 lbs)
2509	Grind Gage No. 6251 - G1	1 x 6.25 in	2	Hegman	8 - 6	0.75 x 3.5 x 9.5 in	5.0 kg
				Micron	0 - 25		(11 lbs)
				NPIRI	0 - 10		
2510	Grind Gage No. 6252 - G2	1 x 6.25 in	2	Hegman	8 - 4	0.75 x 3.5 x 9.5 in	5.0 kg
				Microns	0 - 50		(11 lbs)
				NPIRI	0 - 20		
2511	Grind Gage No. 6254 - G4	1 x 6.25 in	2	Hegman	8 - 0	0.75 x 3.5 x 9.5 in	5.0 kg
				Microns	0-100		(11 lbs)
				NPIRI	0 - 40		
2512	Grind Gage No. PD-250	1 x 6.25 in	2	Microns	0 - 50	0.75 x 3.5 x 9.5 in	5.0 kg
				Microns	0-250		(11 lbs)
2513	Grind Gage No. PB-20	0.5 x 8 in	2	Mils	0 - 20	0.75 x 2.5 x 9.5 in	3.0 kg
							(6.5 lbs)
2516	Grind Gage No. 5252-N	12.7 x 127 mm	2	Microns	0 - 50	12.7 x 63.5 x 171.5 mm	1.8 kg
				Hegman	4 - 8		(4.0 lbs)
				North	5 - 10		
2517	Grind Gage No. 5254-N	12.7 x 127 mm	2	Microns	0-100	12.7 x 63.5 x 171.5 mm	1.8 kg
				Hegman	0 - 8		(4.0 lbs)
				North	0 - 10		
1520	Wedge Printing Plate, Warren-2	76.2 x 165.1 mm	1	Mils	0.3	101.6 x 165.1 x mm	3.4 kg (7.4 lbs)
1521	Wedge Printing Plate, Warren-3	76.2 x 165.1 mm	1	Mils	0.4	101.6 x 165.1 x mm	3.4 kg (7.4 lbs)

Comes complete with: Grind block, Scraper, Reusable Storage Case

Tolerance range for 1509 - 1512: ± 2.5 microns

***Note:** Designed to comply with ISO method 1524

Tolerance range for 2500 - 2517: ± 5.1 microns

Drying Time Recorder

The various stages of drying and curing that occur in films are easy to detect, but difficult to define in terms of chemical and physical principles. In order to evaluate them objectively it is necessary to use instrumentation under controlled conditions.

BYK-Gardner offers the versatile Drying Time Recorder to quantify the various stages of film curing and drying. It delivers reproducible results, and guarantees highest efficiency:

- Simultaneous testing of 6 samples - saves time
- Three different speeds: 6-12-24 hrs - for any application
- Alternative speeds available upon request

Procedure

- Coat the glass strip using the film applicator and holder (order separately below)
- The drying of the paint starts here. If you prepare multiple panels at different times note the time when the draw down was made and add it to the time the sample is in the recorder
- Place needles on the sample strip and select the speed by adjusting the speed switch
- Turn the recorder on – the unit will automatically switch off at the end of the test
- Evaluate the results (see figure at right)

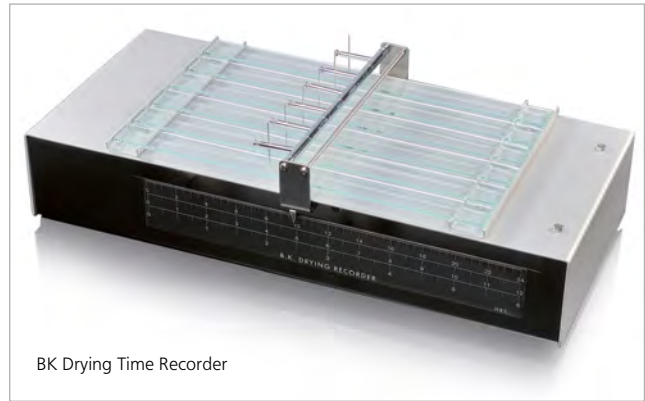

BK Drying Time Recorder

Typical Test Result

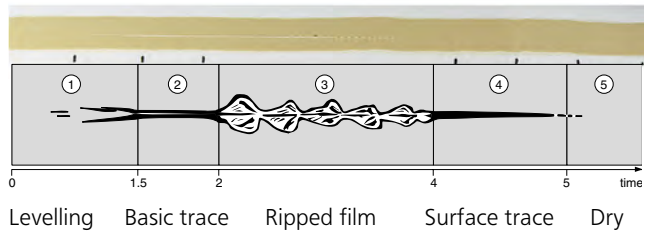

Standards

ASTM	D 5895
ISO	9117-4
DIN EN	14022



Ordering Information

Cat. No.	Description
2711	Drying Time Recorder 115V
2710	Drying Time Recorder 230V

Comes complete with:

Drying Time Recorder
6 Glass panels, 6 Needles 1 mm (2735),
6 Needles 2mm (2737)

Note: The Drying Time Recorder can only be used at room temperature

Technical Specifications

Power Supply	Dimensions	Shipping Weight
115 VAC/60 Hz	49 x 25 x 11 cm (19.3 x 9.8 x 4.3 in)	4.7 kg (10.4 lbs)
230 VAC/50 Hz	49 x 25 x 11 cm (19.3 x 9.8 x 4.3 in)	4.7 kg (10.4 lbs)



Ordering Information

Cat. No.	Description
2735	Needle Set 1 mm
2737	Needle Set 2 mm
2730	Glass Panel Set
2720	Glass Panel Holder
2723	Film Applicator, 12 mm
2736	Weight Set

Accessories

Description
Set of 12; 1 mm diameter with rounded tip
Set of 6; 2 mm diameter with rounded tip
Set of 12
For coating glass panels. Use 2723; dimensions 36 x 4 x 2 cm (14 x 1.6 x 0.8 in)
Stainless steel, 2 gap clearances (38 and 76 µm), gap width 12 mm
Set of 6; 5 grams per weight

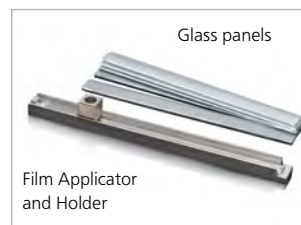

Permeability Cups

The permeability of a coating to water vapor is measured by suspending a free film of the material across the top of a wide shallow cup. Then, in a controlled environment, a desiccant is used to draw water vapor through the film into or out of the cup. Weight loss or gain of the cup's content over aspecified period is used to determine the rate of vapor transmission through the film. The permeability of a film to many other substrates in the gaseous state can be tested in a similar fashion.

Permeability Cup

The BYK-Gardner PERM Cup is a shallow cylinder with a threaded flange, flat retaining washer and threaded ring cover. Rubber gaskets are used to tightly seal the specimen between the cup and the ring cover. The cup and cover are knurled for easier handling.

Two different size cups are available:

- Large 25 cm² cup meets the ASTM standard
- Small 10 cm² cup allows the use of a smaller specimen and less desiccant

Procedure

During a test, vapor passes from the cup through the film specimen to an open container of desiccant or other absorbent material in a controlled environment. The permeability cup and other container are sealed together in a larger container to provide control of the vapor pressure.

Testing may also be set up to allow passage of vapor from a solution in the open container through the test film to desiccant or other absorbent material within the permeability cup.

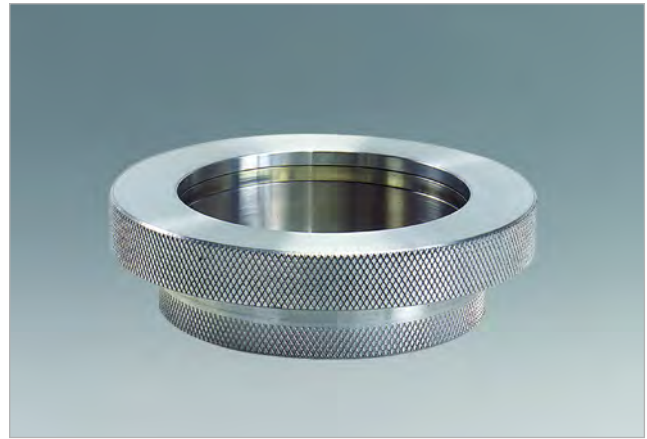

Standards

ASTM	D 1653
ISO	7783-2



Ordering Information

Cat. No.	Description
2300	Permeability Cup S
2301	Permeability Cup L

Comes complete with:

Threaded flange, Cup bottom, Retaining washer, Neoprene gasket, Polyethylene gasket, Operating manual

Technical Specifications

Exposed Area	Dimensions	Net Weight
10 cm ²	6.3 x 2.5 cm (2.5 x 1 in)	76 g (2.7 oz.)
25 cm ²	8.1 x 2.5 cm (3.25 x 1 in)	129 g (4.6 oz.)



Ordering Information

Cat. No.	Description
2302	Polyethylene Gasket L
2303	Neoprene Gasket L
2304	Polyethylene Gasket S
2305	Neoprene Gasket S



Touch the color with our new spectro2guide:

There it is in black and white: The new spectro2guide has arrived. The revolution in color management.



Upfront design. Color touchscreen. Camera preview. Auto calibration. Gloss. Fluorescence. Digital standard...

www.touchthecolor.com

Introduction

Film thickness gages are among the most essential instruments used in the coatings industry. The generally accepted ratio of dry film to wet film thickness of most coatings is:

$$\text{Dry Film} = \frac{\text{Wet Film} \times \% \text{ Vol. Solids of Coating}}{100}$$

Errors in film thickness estimates result in a needless expenditure of time, material, and money. If a film is too thin, its hiding power and protective capabilities may be inadequate and time will be lost in recoating the surface. If a coating application results in a dry film being excessively thick, failures such as cracking, flaking, or excessive drying time may result. Also, there is the cost factor of applying too much coating.

Wet Film Thickness

In order to control the process variables when applying a coating to a surface, it is often desirable that measurements are made to determine thickness while the coating is still wet. Wet film measurement is done by devices based upon the shape of the surface area, and the expected range of thickness. In addition, wet film measurements are also very useful for coating systems where the dry film thickness can only be measured destructively.

Dry Film Thickness

Measuring coating thickness accurately maximizes quality and minimizes material costs. Dry film checking can be carried out non-destructively or destructively, for e.g. multi-layer applications.

Non-Destructive Tests

Electronic type gages with digital display are used. These instruments measure the thickness of insulating coatings on non-magnetic, metal substrates (NFe) and of non-magnetic coatings on steel or iron (Fe). Two different measurement principles are being used:

- Magnetic inductive measurement on Fe-substrates
- Eddy-current measurement on NFe-substrates
- Examples for insulating and non-magnetic coatings: paint, plastic, enamel, chrome, copper, zinc, powder coatings, electro-plating, galvanizing, rubber, hard chrome, sprayed metal, ceramics
- Examples for NFe substrates: aluminum, copper, brass, non-magnetic steel, bronze, magnesium, zinc
- Examples for Fe substrates: steel, cast iron



FILM THICKNESS

Measurement Techniques

Magnetic Induction (Fe):

This method uses two magnet coils where the magnetic field changes if brought near a ferromagnetic substrate. The change of the magnetic field is related to the distance between the probe and the substrate – thus to film thickness. The second of the two coils takes up the magnetic current. This magnetic coupling between both magnetic poles is the measure used for film thickness. In addition, electromagnetic induction uses alternating magnetic fields, generated by a ferromagnetic coil. Today, highly precise Hall-effect semiconductors are integrated in modern ferrous probes.

Eddy-Current Measurements (NFe):

This method is required when measuring non-conductive coatings (NFe) on non-ferromagnetic substrates (NFe) such as aluminum. The eddy-current measurement method is based on the principles of the electromagnetic induction technique. A coil of fine wire conducting a high frequency alternating current sets up a magnetic field which changes its direction according to the alternating current connected. When the NFe probe is brought near a conductive substrate, eddy currents are generated, which affect the magnetic field of the coil. The effect depends on the characteristics of the substrate and the distance between the probe and substrate – i.e. film thickness.

Choosing the Right Probe

It is important to choose the appropriate test method for each application. The following table shows the recommended test methods for different combinations of substrate and coating. The type of substrate is very easily established with a magnet. In case the magnet adheres to the substrate, an Fe substrate is concerned.

Calibration

An accuracy check should be performed once a day by using a certified precision shim. If the measurement is outside of the certified \pm range, a calibration procedure described in the gage's operating manual should be performed. All electronic film thickness gages offer a zero (baseline) calibration function by measuring an uncoated substrate. The more advanced gages allow for two point calibration using a certified precision shim to adjust the gage's calibration curve. The calibration should be performed on a flat, smooth surface.

Coating	Substrate								
	Aluminium	Brass	Bronze	Copper	Steel	Magnesium	Stainless	Titanium	Zinc
Aluminium	--	--	--	--	F	--	--	--	--
Anodizing	N	--	--	--	F	N	--	--	--
Brass	--	--	--	--	F	--	--	--	--
Bronze	--	--	--	--	F	--	--	--	--
Cadmium	--	--	--	--	F	--	--	--	--
Chrome-hard	--	--	--	--	F	--	--	--	--
Copper	--	--	--	--	F	--	--	--	--
Eloxal	N	--	--	--	--	--	--	--	--
Epoxy	N	N	N	N	F	--	N	--	N
Galvanizing	--	--	--	--	F	--	--	--	--
Lacquer	--	--	--	--	F	--	N	--	N
Molybdenum disulphide	--	--	--	--	F	--	N	--	--
Nickel-electroless	--	--	--	--	F*	--	--	--	--
Paint	N	N	N	N	F	N	N	N	N
Plastic	N	N	N	N	F	N	N	N	N
Rubber	N	--	--	--	F	--	--	--	--
Tin	--	--	--	--	F	--	--	--	--
Varnish	N	N	N	N	F	--	--	--	--

N = non-ferromagnetic; F = ferromagnetic

*Note: only if nickel content is 8% or greater

Wet Film Thickness Gages

Measuring the film thickness of freshly applied coatings in the wet stage is very important. On one hand, film thickness influences the quality of a product; on the other hand, applying too much coating can be expensive. Depending on the application method, it is advisable to measure wet film thickness. For measuring wet film thickness, BYKGardner offers a comb or "interchemical gage".

Comb Type Gage

The comb is a ruler-shaped gage with two supports at each of its six sides, having tabs of varying lengths.

- Hexagonal shape made of corrosion resistant stainless steel

The Nordson BYK Gage is a four-sided gage with flat edges of graduated heights. The gage is made from durable stainless steel. A convenient protective pocket holder is provided.

Procedure:

- For measuring, push the comb gage perpendicularly into the film using the measuring range that corresponds to the expected film thickness
- Remove the comb gage from the coating
- The wet film thickness will fall between the clearance of the shortest tab that is wet and the clearance of the next shortest dry tab
- The plastic comb gage may be used up to 60 °C (140 °F)

Standards

ASTM D 4414, D 713

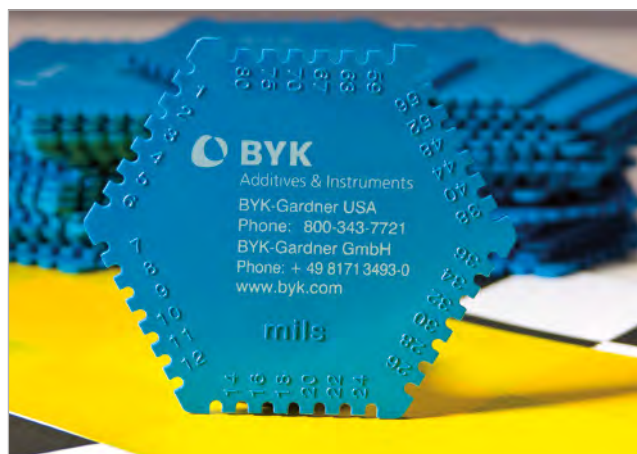

Nordson BYK Gage



Nordson BYK Gage

Ordering Information

Cat. No.	Description
3501	Comb Gage 25-2000 µm, stainless steel
3505	Comb Gage 1-80 mils, stainless steel
3507	Comb Gage 5-150 µm, stainless steel
3509	Comb Gage Set, plastic, set of 10
3510	Comb Gage Set, plastic, set of 100
3517	Nordson BYK Gage

Technical Specifications

Measuring Range	Outer Diameter
25 - 2000 µm	90 mm
1 - 80 mils	90 mm
5 - 150 Mm (0.2 - 6 mils)	58 mm
25 - 2000 µm (1 - 80 mils)	90 mm
25 - 2000 µm (1 - 80 mils)	90 mm
0.5 - 20 mils	38 mm



Interchemical Gages

Wet Film Thickness Gages

The Interchemical Thickness Gage has long been the standard for measuring wet film thickness in the coatings industry. (U.S. Patent No. 3,128,558).

BYK-Gardner offers three basic models in various ranges. All models have an accuracy of +/- 0.0001 in (2.5 µm) or 2.5% full scale, whichever is greater.

The gage consists of an eccentric inner wheel, supported by two larger outer concentric wheels. At a specific point, the inner wheel touches and picks up wet film when the gage is rolled on the coated surface. This critical clearance may be read on a rotating scale.



Model S – General Use

- For general use (original Interchemical design)
- Scale is stamped on the outside of the metal wheel; no rotating scale is used

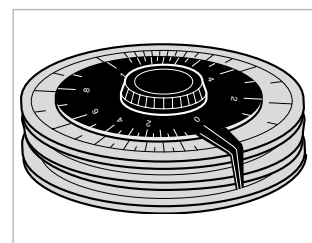
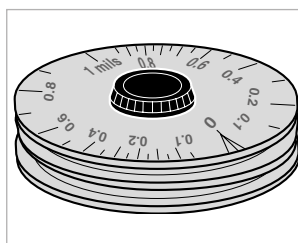

Model R * – Rotating Scale

- For general critical measurements
 - Has a rotating scale to facilitate accurate gage reading
 - No black plate on the opposite side of the wheel is present
- * U.S. Patent No. 3,128,558

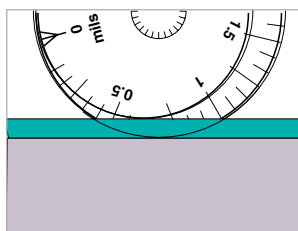

Model L * –

Low Inertial with Rotating Scale

- For very thin coatings and accurate measurements on moving surfaces
 - Inside is hollowed out; very lightweight – only 0.3 lb
 - Black rotating scale to minimize reading errors
 - For identification purposes, this model has a black plate pressed into the wheel on the opposite side of the scale
- * U.S. Patent No. 3,128,558

Standards	
ASTM	D 1212
ISO	2808

Gage Holder

The gages may be held between the thumb and forefinger to take a reading, or it may be inserted into the gage holder. This holder is widely used to measure coatings safely on moving surfaces such as high-speed press rollers. It can also be used on stationary, flat, or curved surfaces since the holder makes it easier to exert a steady, even force on the gage.



Ordering Information

Cat. No.	Description
6580	Holder for Inmont Gage

Accessories

Dimensions	Net Weight	Shipping Weight
6.4 x 5.1 x 17.8 cm (2.5 x 2 x 7 in)	0.2 kg (0.4 lbs)	0.5 kg (1.0 lbs)

Interchemical Gages



Ordering Information

Cat. No.	Description
6500	Inmont Gage L, 0-1 mil
6958	Inmont Gage L, 0-2 mil
6959	Inmont Gage R, 0-1 mils
6511	Inmont Gage R, 0-2 mils
6512	Inmont Gage R, 0-4 mils
6513	Inmont Gage R, 2-12 mils
6514	Inmont Gage R, 10-30 mils
6960	Inmont Gage S, 0-1 mils
6961	Inmont Gage S, 0-2 mils
6962	Inmont Gage S, 0-4 mils
6963	Inmont Gage S, 2-12 mils
6964	Inmont Gage S, 10-30 mils
6515	Inmont Gage L, 0-20 µm
6965	Inmont Gage L, 0-40 µm
6516	Inmont Gage R, 0-20 µm
6541	Inmont Gage R, 0-40 µm
6542	Inmont Gage R, 0-100 µm
6543	Inmont Gage R, 50-250 µm
6544	Inmont Gage R, 200-700 µm
6550	Inmont Gage S, 0-20 µm
6551	Inmont Gage S, 0-40 µm
6552	Inmont Gage S, 0-100 µm
6553	Inmont Gage S, 50-250 µm
6554	Inmont Gage S, 200-700 µm

Comes complete with:

Inmont Film Gage
Operating instructions

Note: Holder must be ordered separately

Info!

Certification available.
Please contact Customer Service for pricing.

Technical Specifications

Scale	Full Scale Calibration Range	Recommended	Resolution
English	0 - 1 mil	0.2 - 0.8 mil	0.05 mil
English	0 - 2 mil	0.4 - 1.6 mil	0.1 mil
English	0 - 1 mil	0.2 - 0.8 mil	0.05 mil
English	0 - 2 mil	0.4 - 1.6 mil	0.1 mil
English	0 - 4 mil	0.8 - 3.2 mil	0.2 mil
English	2 - 12 mil	3 - 11 mil	0.5 mil
English	10 - 30 mil	11 - 20 mil	1.0 mil
English	0 - 1 mil	0.2 - 0.8 mil	0.05 mil
English	0 - 2 mil	0.4 - 1.6 mil	0.1 mil
English	0 - 4 mil	0.8 - 3.2 mil	0.2 mil
English	2 - 12 mil	3 - 11 mil	0.5 mil
English	10 - 30 mil	11 - 20 mil	1.0 mil
Metric	0 - 20 µm	4 - 16 µm	1 µm
Metric	0 - 40 µm	8 - 32 µm	2 µm
Metric	0 - 20 µm	4 - 16 µm	1 µm
Metric	0 - 40 µm	8 - 32 µm	2 µm
Metric	0 - 100 µm	20 - 80 µm	5 µm
Metric	50 - 250 µm	70 - 230 µm	10 µm
Metric	200 - 700 µm	250 - 650 µm	25 µm
Metric	0 - 20 µm	4 - 16 µm	1 µm
Metric	0 - 40 µm	8 - 32 µm	2 µm
Metric	0 - 100 µm	20 - 80 µm	5 µm
Metric	50 - 250 µm	70 - 230 µm	10 µm
Metric	200 - 700 µm	250 - 650 µm	25 µm
Dimensions	5 cm dia x 2.5 cm (2 in dia x 1 in)		
Net Weight	Model L: 0.1 kg (0.3 lbs) / Model R/S: 0.2 kg (0.5 lbs)		
Shipping Weight	Model L/R/S: 0.34 kg (0.75 lbs)		

Appearance

Color

Film Thickness

Technical Service

Index

byko-test 4200/4500

Dry Film Thickness Gages

The byko-test 4500/4200 film thickness gauges allows for the measurement of a variety of products. No cable exchange or calibration is needed when changing from a ferrous to a non-ferrous substrate. The large LCD display and 10 second retention of the last measured value makes the byko-test 4500/4200 easy to use.

- Compact pocket size instrument
- One-handed design for ease of use
- Switchable from mils to microns
- Strong, wear resistant ruby probe tip
- V-groove in probe for positioning on cylindrical parts
- Acoustic signal for measurement confirmation
- Automatic substrate recognition
- Extended measuring range
- Faster measuring speed
- Graphic display with backlight

For sample areas that are difficult to reach, the byko-test 4500/4200 EC models come with an 1 meter length extension cable. The extension cable offers more flexibility to position the sensor.

Standards

ASTM	B 499, D 1186, D 1400, D 7091
BS	3900 Part C5, 5411 (3,11)
DIN	50981, 50984
ISO	2360, 2808, 2178



byko-test with extension cable



Ordering Information

Cat. No.	Description
3634	byko-test 4200 Fe
3636	byko-test 4200 Fe EC, probe 3638
3635	byko-test 4500 Fe/NFe
3637	byko-test 4500 Fe/NFe EC, probe 3639

Cat. No. 3635 Comes complete with:

- byko-test gage
- Carrying case with zero plates
- Operating instructions
- Calibration Certificate
- 2 AA batteries
- Extension cable (1meter) for 3636, 3637 only

Technical Specifications

Substrate Fe	steel or iron
Substrate NFe	non-magnetic metals: aluminum, copper, brass, zinc, stainless steel
Measuring Range	Fe: 0 - 3000 μ m (0 - 120 mils) NFe: 0 - 3000 μ m (0 - 120 mils)
Accuracy	\pm (2 μ m + 3 %*)
Minimum Curvature	5 mm (0.2 in) convex; 30 mm (1.2 in) concave
Minimum Substrate Thickness	Fe: 0.2 mm (0.01 in), NFe 0.05 mm (0.002 in)
Minimum Area of Measurement	10 x 10 mm (0.4 x 0.4 in)
Operating Temperature	0 - 60 °C (32 - 140 °F)
Power Supply	2 x AA Batteries
Dimensions	100 x 62 x 27 mm (4 x 2.5 x 1.1 in)
Weight	approx. 130 g (4.6 oz) with battery

*Note: Percent of measured value.

byko-test 8500

The byko-test 8500 film thickness gage has a modular design to accommodate a wide range of applications. Multiple sensor probes are available for maximum flexibility. Coating thickness can be measured on a wide variety of metal substrates: copper, aluminium, zinc, brass, and titanium.

- Illuminated graphical display and keypad
- Easy to use menu
- One-hand operation
- Flip display by 180 degrees
- Multi-language support
- Modular design with exchangeable probes
- Automatic and user specific calibration
- Wireless data transfer to PC (optional)
- Durable, wear-resistant ruby probe tip
- V-groove in probe for measuring cylindrical parts
- Acoustic signal for measurement confirmation

Two models are available for different requirements:

Basic version

With all important functions needed to measure and evaluate the thickness of non-metal layers on metal substrates. Basic statistical functions, memory for up to 100 readings, optional wireless connection to a PC and data transfer to Excel.

Premium version

Enhanced memory functions, batch measurement with up to 13000 measurements in 200 batches, memory for up to 100 custom calibrations, software and wireless data transfer, average zero adjustment for rough substrates, single and continuous measurement modes included.



Standards

ASTM	B 499, D 1400, D 1186, D 7091
BS	3900 Part C5, 5411 (3,11)
DIN	50981, 50984
ISO	2178, 2360, 2808, 19840

Technical Specifications

Resolution	0.1 μm 0 - 99.9 μm, 1 μm 100 - 999 μm 10 μm ≥ 1000 μm
Accuracy	± (1 μm + 2%*) 0 - 2000 μm ± 3,5%* > 2000 μm
Measurement Range	0 - 2000 Mm (0 - 78 mils)
Minimum Area of Measurement	Fe: 10 x 10 mm (0.79 x 0.79 in); NFe: 10 x 10 mm (0.79 x 0.79 in)
Minimum Curvature	convex 5 mm (0.20 in); concave 30 mm (1.2 in)
Minimum Substrate Thickness	Fe: 0.2 mm (0.008 in); NFe: 0.05 mm (0.002 in)
Communication	Wireless Connection 2.4 GHz, distance max. 10 m
Temperature Range	Storage -10°C (14°F) to 60°C (140°F) Usage 0°C (32°F) to 50°C (122°F)
Power Supply	2 x Mignon-Batteries (AA) 1.5V Alkali or rechargeable-Batteries (AA) 1.2V
Dimensions	124 mm x 67 mm x 33 mm (4.9 x 2.6 x 1.3 in)
Weight	ca. 120g (instrument with batteries and probe)

*Note: Percent of measurement value.



Ordering Information

Cat. No.	Description
3661	byko-test 8500 B Fe
3662	byko-test 8500 B NFe
3663	byko-test 8500 B Fe/NFe
3664	byko-test 8500 P Fe
3665	byko-test 8500 P NFe
3666	byko-test 8500 P Fe/NFe

byko-test 8500 basic comes complete with:

Instrument ; 2 mm Standard Sensor; 2 Mignon-Batteries 1.5V (AA) (Alkaline); Adapter cable for external sensor; Instruction manual; Certificate for sensor; softbag; carrying case; Zero plates

byko-test 8500 premium comes complete with:

Instrument; 2 mm Standard Sensor; 2 Mignon-Batteries 1.5V (AA) (Alkaline); Adapter cable for external Sensor; Instruction manual; Certificate for sensor; Softbag; Carrying Case; Zero plates; Software; USB-wireless connector incl. Elongation cable

Wireless Sensor

Wireless Sensor for areas difficult to access with internal and external sensors. The new wireless sensor for the byko-test 8500 is built for all applications requiring a small sensor without direct connection to the instrument.

byko-test 8500 wireless sensor has a long lasting rechargeable batteries, a broad reach of 12 m and is available as single or dual sensor.

Thickness Standards

For control and inspection purposes individual shims or sets of thickness standards are available.



Certified Calibration Shims

These plastic shims (3740/3741) aid in the calibration of thickness gages on ferrous or non-ferrous metallic substrates. Plastic shims can be used to calibrate on the actual test substrate.

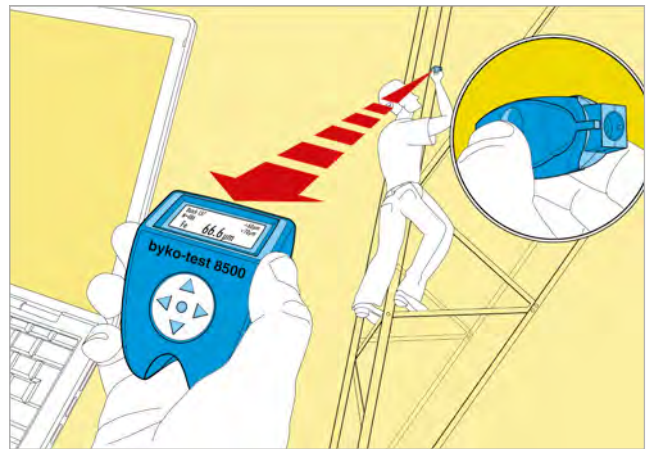

Accessories

Cat. No.	Description
3640	byko-test 8500 B, no sensor
3641	byko-test 8500 P, no sensor
3642	Fe-sensor 2000 μm
3643	Fe-sensor 5000 μm
3644	NFe-sensor 2000 μm
3645	Dual-Sensor 2000/2000
3646	Dual-Sensor 5000/2000
3740	Calibration Shims 25-500 μm
3741	Calibration Shims 11-980 μm
3647	byko-test 8500 Software
3648	USB-wireless connector
3667	Wireless Fe-Sensor
3668	Wireless NFe Sensor
3669	Wireless Dual Fe/NFe Sensor
3649	Probe Cable, 1 meter

DUALSCOPE MPOR

The DUALSCOPE MPOR film gage allows quick and easy measurements of coatings thickness on ferrous and non-ferrous substrates. The instrument automatically identifies the kind of substrate and selects the appropriate test method accordingly.

The instrument is designed for one-hand operation. An integrated spring guarantees a constant pressure of the probe to the sample's surface. The instrument comes with an USB interface for bi-directional data transmission to the Data Center Software. Data can be exported to Excel spreadsheet.

DUALSCOPE MPOR:

- Compact size instrument
- Illuminated display
- Statistic function, min., max., mean, Std. dev.
- Two displays for easy view for measurement results
- Magnetic-induction Fe-sensor particularly suitable for the automotive industry
- Eddy current method for non-ferrous substrates
- Large memory stores up to 10.000 values
- Indicator LED for pass/fail
- Conductivity compensation for measurements on aluminum alloys
- Continuous scan of measurement surface
- Easy to use menu navigation
- Automatic turning display
- Two special measuring modes to conform to IMO PSPC (90/10 rule) and SSPC-PA2



Standards

ASTM	B 499, D 1400, D 7091
BS	3900 Part C5, 5411 (3,11)
DIN	50981, 50984
ISO	2178, 2360, 2808

Technical Specifications

Substrate Fe	steel or iron
Substrate NFe	non-magnetic metals: aluminum, copper, brass, zinc, stainless steel
Measuring Range	0 - 2000 µm (0 - 78 mils)
Memory	10,000 values
Accuracy	0 - 75 µm: ≤1.5 µm (Fe) 0 - 50 µm: ≤ 1.0 µm (NFe) 75 - 1000 µm: ≤ 2% of reading (Fe) 50 - 1000 µm: ≤ 2% of reading (NFe) 1000 - 2000 µm: ≤ 3% of reading (Fe) 1000 - 2000 µm: 3% of reading (NFe)
Minimum Curvature	5 mm (0.2 in) convex 32 mm (1.2 in) concave
Minimum Substrate Thickness	Fe: 0.1 mm; NFe: 0.02 mm
Min. Measuring Area	2.5 x 2.5 mm (0.1 x 0.1 in)
Operating Temperature	0 °C - 40 °C (32 °F - 104 °F)
Power Supply	2 x AA batteries
Dimensions	64 x 30 x 85 mm (2.5 x 1.2 x 3.3 in)
Weight	approx. 137g (4.8 oz) with battery

Accessories

For exporting measurement data to Excel®



Ordering Information

Cat. No.	Description
3686	DUALSCOPE MPOR

Comes complete with:

DUALSCOPE MPOR gage
Manual
2 x AA batteries
Protective bag
Zero standard Fe/NFe
Thickness standard
Protective cap
Lanyard
Calibration certificate
PC Datex software
Data Center software
USB cable
Instrument case



Ordering Information

Cat. No.	Description
3695	PC-Datex Software with USB Cable

micro-TRI-gloss μ

Gloss and Film Thickness in one Instrument

Gloss and film thickness are important QC criteria for coatings. The new micro-TRI-gloss M measures both in seconds and at the same position. This saves time and is ideal for checks in the field.

- Simultaneous display 20°, 60°, 85° - for high gloss to matte coatings
- Dual sensor Fe/NFe - measures thickness on steel as well as on aluminum
- Automatic check of glossmeter calibration standard
- Easy, multilingual menu operation with scroll wheel
- Statistics, Differences and Pass/Fail
- Memory for 999 readings with name input
- easy-link software included for professional documentation in Excel®
- Data transfer from the glossmeter to PC via USB or Bluetooth® wireless technology



Standards

	Gloss	Thickness
ISO	2813	2178, 2360, 2808
ASTM	D 523	B 499, D 1400
DIN	67530	

Technical Specifications

Gloss		
Geometry	Application	Measurement Area
20°	high gloss	10x10 mm (0.4x0.4 in)
60°	semi gloss	9x15 mm (0.35x0.6 in)
85°	low gloss	5x38 mm (0.2x1.5 in)
Measurement Range	0 - 100 GU	100 - 2000 GU
Repeatability	± 0.2 GU	± 0.2 %
Reproducibility	± 0.5 GU	± 0.5 %
Thickness		
Substrate	Fe: magnetic	NFe: non magnetic
Measurement Range	0 - 500 μ m (0 - 20 mils)	
Accuracy	± (1.5 Mm +2% of measured value)	
Dimensions	155 x 73 x 48 mm (6.1x2.9x1.9 in)	
Weight	400 g (0.9 lbs)	

Accessories

For data transfer from the glossmeter to a PC, USB-A
Software for professional analysis in the lab (see page smart-lab Gloss)
Replacement
High gloss and 3 Semi gloss tiles, 170 x 103 x 26 mm (6.7 x 4.1 x 1 in)

Certified For Certification Services and Preventive Maintenance see pages about Technical Service.



Ordering Information

Cat. No.	Description
4564	micro-TRI-gloss μ
107304448	Extended Warranty one year additional

Comes complete with:

micro-TRI-gloss μ glossmeter
 Calibration holder with certificate
 Zero standards Fe and NFe
 USB-cable
 Operating manual
 Battery
 Durable carrying case

Note: After software download both software packages can be used for 30 day free trial. Thereafter, the user needs to decide and register for one software package.



Ordering Information

Cat. No.	Description
4405	USB-Cable
4866	Software smart-lab Gloss
4449	Calibration Holder
4434	Checking Standard TRI

byko-cut universal

Portable instrument providing sufficient accuracy for laboratory use but also usable at construction sites and in workshops. Ideal for customer service technicians and demonstrations. The BYK-Gardner byko-cut is a universal instrument for:

- Measuring film thickness in the range of 2 - 2000 Mm (1/8 - 80 mils) on every substrate (steel, non-ferrous metal, plastics, wood, etc.)
- Capable of multi-layer film thickness analysis
- Adhesion test by means of cross-cut test in accordance with ASTM D 3359; DIN 53 151
- Indentation hardness test in accordance with ISO 2815 (Buchholz)
- Microscopic research for pores, pits, cracks, blisters, flaking, intercoat adhesion of the individual film in coat systems, and quality control of the pretreatment of the substrate

Special features:

- LED illumination
- Ergonomical design
- Guiding wheels for smooth cutting
- Cut finder



Standards

ASTM	D 3002, D 3359, D 4138
DIN	50 986, 53 151
ISO	2409, 2815
NCCA	II-13, X-1
VTLA	003 Item 9



Ordering Information

Cat. No.	Description
3430	byko-cut thickness, Metric
3431	byko-cut thickness, English
3432	byko-cut no cutters, Metric
3433	byko-cut no cutters, English

Comes complete with:

byko-cut universal film gauge
 Revolving rotary head with 3 cutters for film thickness (# 1-3)
 Built-in microscope (scale 0 - 2 mm)
 LED
 Battery
 Operation manual

Note: Cutters must be ordered separately for Cat. No. 3432 Tools for cross-cut and hardness must be ordered separately

Technical Specifications

Lamp	Batteries	Microscope	Dimensions
White LED	1.5 Volts Mignon type	50-fold magnification	110 x 80 x 75 mm (4.3 x 3.2 x 2.9 in)
White LED	1.5 Volts Mignon type	50-fold magnification	110 x 80 x 75 mm (4.3 x 3.2 x 2.9 in)
White LED	1.5 Volts Mignon type	50-fold magnification	110 x 80 x 75 mm (4.3 x 3.2 x 2.9 in)
White LED	1.5 Volts Mignon type	50-fold magnification	110 x 80 x 75 mm (4.3 x 3.2 x 2.9 in)

Info!

For more information on Buchholz hardness see chapter "Hardness"



The V-shaped cut can be easily stored as an image with the Digital Pocket Microscope. For more details please see chapter "Microscopes"

Destructive Film Thickness Measurement

Create a V-shaped cut through the coating down to the substrate and measure width of a' (b'), which is proportional to the thickness a (b).

The specially designed blades which are attached to the instrument are used to make a short incision in the film. Then, the depth of the layer is measured with the built-in 50 fold microscope and the film is inspected for flaws.

Each of the cutting tips has two bevels which are made to precision with the mentioned slopes (see table). Since the slope of the cut is known, the measurement of the horizontal distance across this full slope (from the substrate to the top edge of the cut) is also a measurement of true vertical depth.

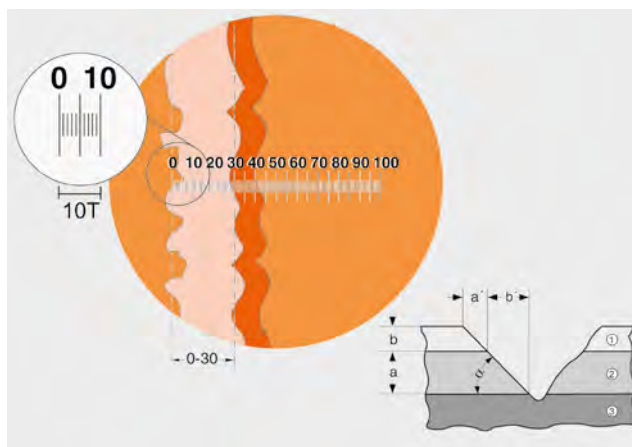

The thickness of multiple-layered coatings can be easily determined.



Ordering Information

Cat. No.	Description
3421	Thickness Cutter 1, 2000, byko-cut
3422	Thickness Cutter 2, 1000, byko-cut
3423	Thickness Cutter 3, 200, byko-cut
3419	Thickness Cutter 100, byko-cut
3420	Thickness Cutter 3000, byko-cut

*Note: Angle measured from sample plane.

**Note: For film thickness below 15 μm , accuracy is +1.5 μm

Technical Specifications

Slope of Tip* (cutting angle)	Maximum Coating Thickness	1 Division on Reticle Scale Represents (Depth)	Accuracy in Microns ± 1 increment**
45°	2000 μm (80 mils)	20 μm (1.0 mils)	40
26.5°	1000 μm (40 mils)	10 μm (0.5 mils)	20
5.8°	200 μm (8 mils)	2 μm (0.1 mils)	4
3.0°	100 μm (4 mils)	1 μm (0.05 mils)	
56°	3000 μm (120 mils)	30 μm (1.5 mils)	

DPM 300

Digital Pocket Microscope

Features of DPM 300 Digital Pocket Microscope

- High resolution CCD-Camera offering clear images
- Very portable and easy to use
- USB Cable connection for the data transfer
- Auto Gain function to adjust the lightness differences
- 4 LED Illumination for better viewing
- Capture button to save image

Destructive Film Thickness

The V-shaped cut from the byko-cut can be easily stored as an image with film thickness info in mm. Also the width from the cut can be detected and recalculated to the film thickness of the coating depending on the cut-Angle.



Info!

For more information on DPM 300 please see section microscopes

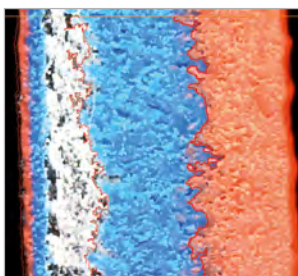

Buchholz Indentation Hardness

Place the byko-cut universal equipped with tool (Cat. No. 3427) and slip-on weight (Cat. No. 3434) on measuring position in accordance with standard. After 30 seconds measure indentation length using the built-in microscope.

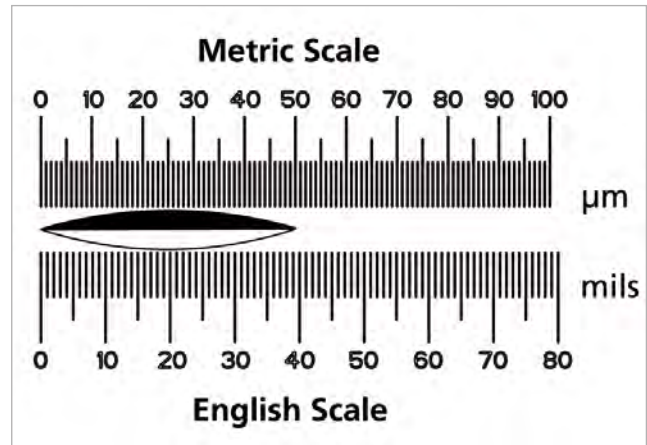

Ordering Information

Cat. No.	Description
3427	Buchholz Tool, byko-cut
3434	Buchholz Slip-on Weight, byko-cut

Technical Specifications

In accordance with DIN 53153 and ISO 2815
Increases weight of byko-cut universal to the standard weight of 500 g ± 5g

Multi-Cut Tool for Cross-Cut Test

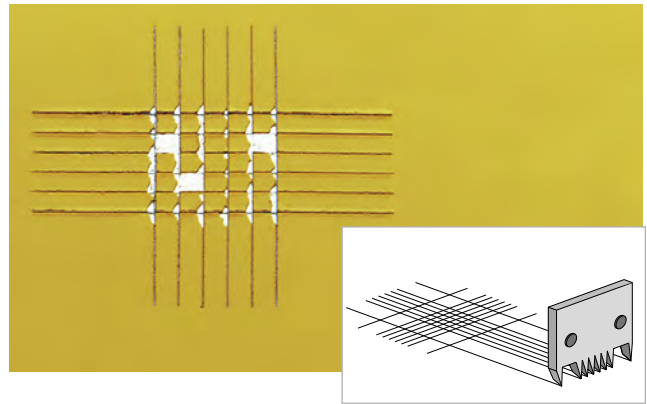

Ordering Information

Cat. No.	Description
3429	Cross-Cut Tool 11, 1-edge 1 mm
3424	Cross-Cut Tool 11, 1-edge 1.5 mm
3425	Cross-Cut Tool 6, 1-edge 1 mm
3426	Cross-Cut Tool 6, 1-edge 2 mm

Technical Specifications

Standard	Cutter Spacing	No. Of Cutters
ASTM	1 mm (0.04 in)	11
ASTM	1.5 mm (0.06 in)	11
DIN, ISO	1 mm (0.04 in)	6
ASTM, DIN ISO	2 mm (0.08 in)	6

Introduction

Hardness

The definition of hardness has, in the past, caused misunderstandings within the paint industry. Most coatings are viscoelastic, and hence will indent to some extent. Therefore, DIN 55 945 defines hardness as follows:

Hardness is the resistance of a coating to a mechanical force, such as pressure, rubbing or scratching.

In practice, different testing methods are used:

Pendulum Hardness

– In accordance with methods described by König and Persoz

Indentation Hardness

– Buchholz Indentation Testers

Scratch Hardness

– Hardness Meter Dur-O-Test
– Pencil Hardness

For clear communication of test results, the technician needs to document the type of test method used, for example, "Indentation Resistance in accordance with ISO 2815" or "Damping Time in accordance with ISO 1522".

BYK-Gardner offers instrumentation needed to perform various hardness tests.



HARDNESS

Pendulum Hardness

This method evaluates hardness by measuring the damping time of an oscillating pendulum. The pendulum rests with 2 stainless steel balls on the coating surface. A physical relationship exists between oscillation time, amplitude and the geometric dimensions of the pendulum. The viscoelastic behavior of the coating determines its hardness.

When the pendulum is set into motion, the balls roll on the surface and put pressure on the coating. Depending on the elasticity, the damping will be stronger or weaker. If there are no elastic forces, the pendulum will damp stronger. High elasticity will cause weak damping.

Two types of pendulums were standardized for this test method:

	König	Persoz
Weight	200 g ± 0.2	500 g ± 0.1
Diameter	0.2 in (5 mm)	0.3 in (8 mm)
Deflection Start	6°	12°
Deflection End	3°	4°
Period of Oscillation	1.4 s	1 s
Damping Time on Glass	250 ± 10 s	430 ± 10 s

Scratch Hardness

An ideal test for the quick evaluation of finished products. The results do not correlate with any of the other methods of hardness measurement.

The scratch can be performed with either a metal pin (Dur-O-Test) or pencils. Pencils of various degrees of hardness are drawn over the coating surface to determine which pencil causes indentation. This method is only applicable for smooth surfaces.

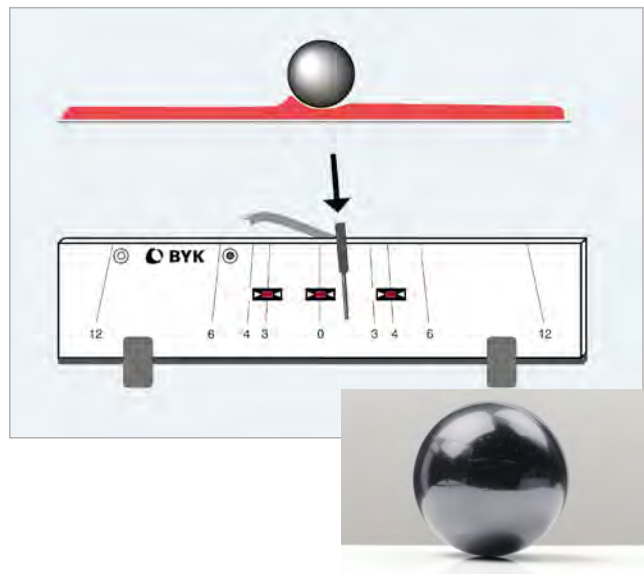
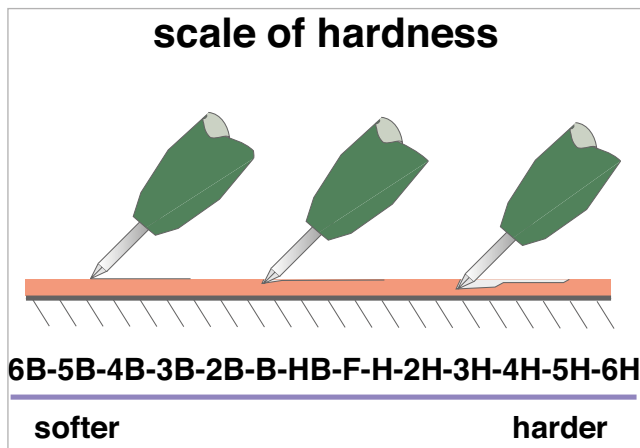

"Buchholz" Indentation Hardness

This test method is suitable for coatings with plastic deformation behavior. Coatings with elastic deformation behavior should not be evaluated with this test method, because after removal of the instrument an elastic coating will show no or very little indentation.

The instrument consists of a double cone block, which is placed on the coating for 30 seconds. Indentation is measured with the help of a precision microscope and is then calculated according to the following equation:

$$\text{Indentation Resistance (Buchholz)} = \frac{100 \text{ mm}}{\text{Indentation Length}}$$

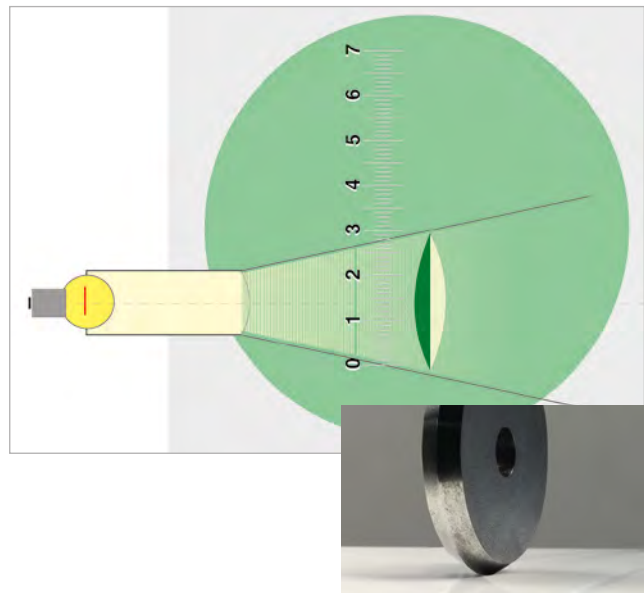

Pendulum Hardness Tester

Simple laboratory measuring instrument for hardness measurements in accordance with the König and Persoz methods described on the previous page.

- Automatic counter with acoustic signal when the deflection is below 3° (König) or 4° (Persoz) respectively
- Registration of pendulum deflection by means of 2 light barriers
- Digital counter
- Changeable from König to Persoz by means of a third light barrier
- Selector switch for display in seconds or number of oscillations



König Pendulum



Persoz Pendulum



Standards

ASTM D 4366

ISO 1522



Ordering Information

Cat. No.	Description
5858	Pendulum Hardness Test König
5859	Pendulum Hardness Test Persoz
5861	Pendulum Hardness Test König/Persoz

Comes complete with:

Pendulum hardness tester; Protective cover; Cable release;
Tools; Pendulum (for 5861 two pendulums)
Glass plate; Spirit level; Power cord; Operating manual

Technical Specifications

Weight	Ball Diameter	Deflection Start/End	Period of Oscillation	Damping Time on Glass
200 g ± 0.2	5 mm	6° / 3°	1.4 s	250 s ± 10 s
500 g ± 0.1	8 mm	12° / 4°	1 s	430 s ± 15 s according to ISO

Voltage 115 V / 60 Hz, 230 V / 50 Hz

Power Supply 0.1 A

Dimensions 320 x 710 x 300 mm (12.6 x 30 x 12 in)

Weight 17.5 kg (39 lbs)



Ordering Information

Cat. No.	Description
5860	Cable Release
5857	Persoz Pendulum
5856	König Pendulum

Accessories

Additional Description

For 5858, 5859, 5861

Additional Pendulum

Additional Pendulum

Buchholz Indentation Tester

The Buchholz indentation test is a reliable test method for evaluation of indentation resistance of plastic deformable coatings.

- Dimensions and weight in accordance with standards
- Block of stainless steel
- Circular tool is a double cone block
- Circular tool and support of tungsten carbide / hard metal
- Marking triangle for precise positioning

Standards

ISO	2815
-----	------



Ordering Information

Cat. No.	Description
5825	Buchholz Tester
5826	Buchholz Tester w/microscope
5824	Precision Microscope

Technical Specifications

Comes complete with

Instrument block (500g ± 5g), Instrument weight: 1.9 kg
 Instrument block (500g ± 5g) incl. precision microscope
 20x magnification with graduated scale to measure indentation length,
 incl. light source; Weight: 0.8 kg

DUR-O-Test

Hardness Meter

This pocket instrument allows hardness tests on flat and curved surfaces. The instrument consists of a sleeve with a pressure spring that can be bent to various tensions by using a slide. The spring acts on a tungsten carbide needle with its tip extending out of the sleeve. A locking screw fixes the slide, thus maintaining constant spring tension.

Three pressure springs of varying strengths ranging from 0-20 N (0-2000g) are available to cover a large hardness range.



Standards

DIN	55656
-----	-------



Ordering Information

Cat. No.	Description
5810	DUR-O-Test, 1 mm
5811	DUR-O-Test, 0.75 mm

Comes complete with:

Hardness tester DUR-O-Test
 3 pressure springs in a leather case

Accessories

Cat. No.	Description
5813	Hard Metal Needle 1 mm
5814	Hard Metal Needle 0.75 mm

Technical Specifications

	Dimensions	Weight
Hardness tester with spherical test tool	Length: 160 mm (6.3 in), Diameter: 16 mm (0.6 in)	0.3 kg (0.7 lbs)

Springs

No. 1 silver 0 - 3 N (0 - 300 g) division: 10 g, Tolerance: ±0.34N
 No. 2 red 0 - 10 N (0 - 1000 g) division: 50 g, Tolerance: ±1.03N
 No. 3 blue 0 - 20 N (0 - 2000 g) division: 100 g, Tolerance: ±1.84N

Pencil Hardness Tester

(Wolff-Wilborn)

The purpose of scratch hardness tests is to determine the resistance of coating materials or lacquers to scratch effects on the surface. This test is of particular value for furniture or vehicle lacquers, but is also a useful aid in the development of synthetic resins or other film forming materials.

Generally, scratch hardness is measured by moving a sharp object under a known pressure over the test surface. The result may either be the value of the pressure required to scratch through the test material if a scratching tool of constant hardness is used, or the hardness of the scratching tool is varied while constant pressure is applied.

- Twenty pencils (grade 9B to 9H) are used with a standard holder
- Pencils are moved with a fixed pressure of 750 grams and a fixed angle ensuring the least amount of operator error
- Pencils can be easily exchanged to minimize down time during the test



Ordering Information

Cat. No.	Description
5800	Wolff-Wilborn Pencil Hardness
5801	Pencil set (20 pcs), for 5800

Comes complete with:

Pencil hardness tester 5800
 Complete set of 20 pencils from 9B to 9H
 Pencil sharpener
 Abrasive 400 grit paper
 Carrying case
 Operating manual

Standards

ASTM	D 3363
BS	3900-E19
ECCA	ECCA T
ISO	15184
DIN EN	13523/4 :2001-12

Pencils

The Pencil Hardness test is an effective method to test coatings for their hardness and their scratch wear resistance. ASTM test method D 3363 allows the use of pencils of known hardness to be moved over the surface of the test sample at a fixed angle and pressure to perform the test.



Standards

ASTM D 3363



Ordering Information

Cat. No.	Description
9500	Pencil Hardness Tester Set
5802	Lead Holder, for 9500
9512	Replacement Leads, Grade 6B, for 9500
9513	Replacement Leads, Grade 5B, for 9500
9514	Replacement Leads, Grade 4B, for 9500
9515	Replacement Leads, Grade 3B, for 9500
9516	Replacement Leads, Grade 2B, for 9500
9517	Replacement Leads, Grade B, for 9500
9518	Replacement Leads, Grade HB, for 9500
9519	Replacement Leads, Grade F, for 9500
9520	Replacement Leads, Grade H, for 9500
9521	Replacement Leads, Grade 2H, for 9500
9522	Replacement Leads, Grade 3H, for 9500
9523	Replacement Leads, Grade 4H, for 9500
9524	Replacement Leads, Grade 5H, for 9500
9525	Replacement Leads, Grade 6H, for 9500

Accessories

Quantity
1
12 per pack
12 per pack
12 per pack
12 per pack
12 per pack
12 per pack
12 per pack
12 per pack
12 per pack
12 per pack
12 per pack
12 per pack
12 per pack
12 per pack

Comes complete with:

Pencil Holder Set 9500, 10 grades of leads:
2B, HB, F, H, 2H, 3H, 4H, 5H, 6H, in packs of 12 each

Introduction

Flexibility / Elasticity

In practice, three different empirical test procedures are used to assess the resistance of coatings and allied products to cracking and/or detachment from the substrate under different conditions of deformation.

Bend Test

Bending lacquered sheet metal over a defined radius allows an indication of the elongation and adhesion of a paint film due to bending stress.

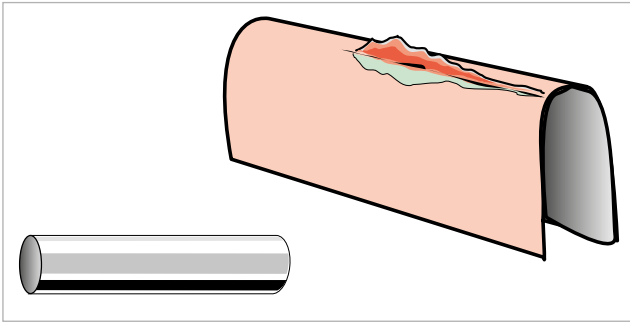

The DIN EN ISO 1519 standard only permits the use of cylindrical mandrels.

The ASTM D 522 and the DIN EN ISO 6860 standards describe the test method by means of a conical or cylindrical mandrel.

The use of a conical mandrel bending tester enables testing of a large variety of bending radii at the same time.

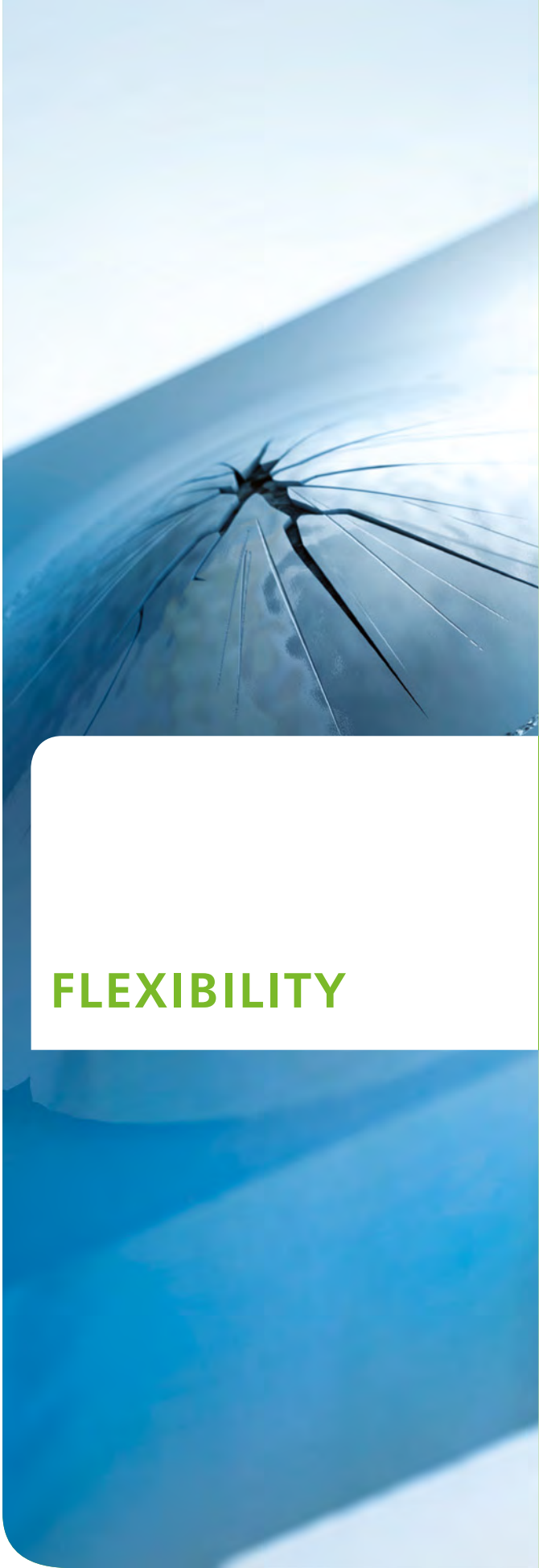
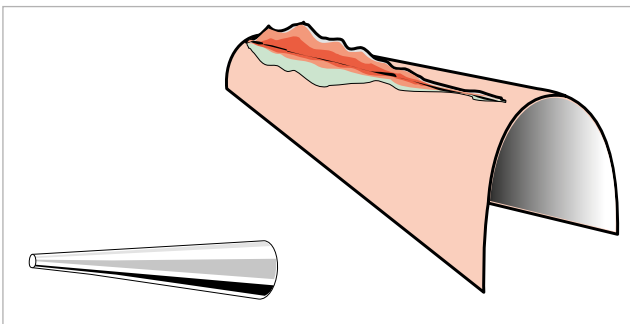

FLEXIBILITY

Impact Test – “Falling-weight Test”

The impact tester has gained wide acceptance in testing the impact resistance of many types of coatings and substrates. International standards describe a method for evaluating impact resistance of a coating to cracking and peeling from a substrate when it is subjected to a deformation caused by a falling weight, dropped under standard conditions yielding rapid deformation.

Impact Tester

- Consists of a solid base with a guide tube support
- The guide tube has a slot to direct a weight that slides inside the guide tube
- A collar fits on the tube that helps the user slide the weight up to the accurate height
- Graduations are marked along the slot to facilitate readings

Procedure

- Place sample under the punch
- Lift the weight to desired height on guide tube and let it drop
- View the damage of the sample visually or with low powered magnification
- Adjust the height and weight of the impacter to determine exact point of failure or establish pass/fail specifications

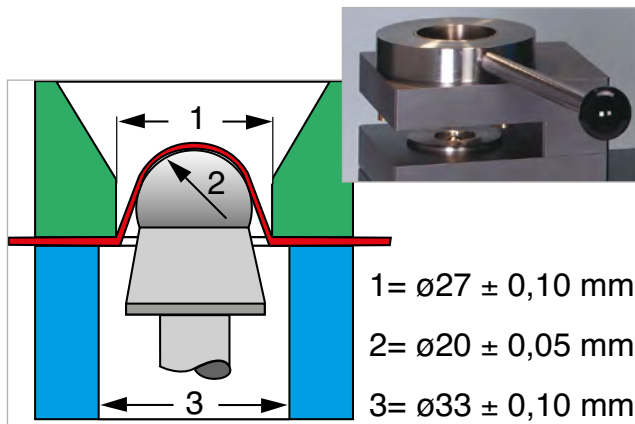
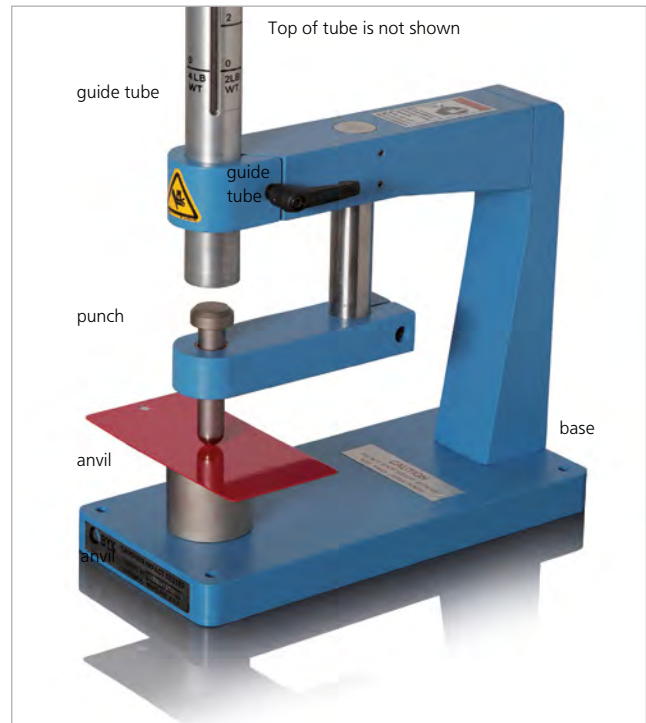

Cupping Test

In addition to determining the deformability or elongation of a film, the cupping test method supplies information on adhesion properties. Single-layer systems can be tested as well as multiple-layer systems.

The ISO standard describes a method for evaluating the resistance of a coating to cracking and/or detachment from a metal substrate when it is subjected to a gradual deformation by indentation under standard conditions.

The impact force is calculated using the following equation:

Falling Height x Weight = Impact Force

in	lbs	in-lb
m	kg	mkg

Note: The coated or uncoated side of the panel can be tested to simulate either indentation or bulging.



A die having a hardened and polished surface and a sample holder with a retaining ring are the heart of a cupping tester. The indenter that contracts the test panel is of hardened polished steel and forms a hemisphere of 20 mm (8 in) diameter. The maximum cupping depth is approx. 14 mm. The test process is observed through a microscope or magnifying glass. When evaluating the test results, it must be carefully assessed when the coating system starts cracking.

Impact Tester

Falling Dart Impact Tester

The Falling Dart Impact Tester determines the mechanical properties of packaging materials such as plastic film, laminates, and paper. The impact tester is designed to determine the amount of energy required for sample failure from a free falling dart.

The tester consists of a base with a sample clamping device and a rubber gasket to prevent sample slippage. The cylinder below the clamping device has 3 mm thick soft rubber to prevent dart damage. The dart is polished aluminium with a vertical shaft to add additional weights. The stand has vertical column made of steel with a release mechanism to attach the dart. The release mechanism is adjustable for positioning the height.



Standards

ASTM D 1709

ISO 7765-1



Ordering Information

Cat. No.	Description
5530	Drop Dart Impact Tester, A
5531	Drop Dart Impact Tester, A/B

Technical Specifications

Falling Height	Dart Diameter	Dart Weight	Weight	Dimensions
660 mm (26 in.)	38.1 mm (1.5 in.)	50 gm $\pm 0.5\%$	19 kg (42 lb)	100 x 60 x 49 cm (39.4 x 23.6 x 19.3 in.)
1500 mm (59 in.)	50.8 mm (2.0 in.)	300 gm $\pm 0.5\%$	48 kg (105 lb)	193 x 60 x 60 cm (76.0 x 23.6 x 23.6 in.)

Comes complete with:

Base with holding device, Vertical column, Dart,
Release mechanism, Nylon clamp;
Additional weights:

For 5530 :

- 10 pcs of 5 grams
- 8 pcs of 15 grams
- 8 pcs of 30 grams
- 8 pcs of 60 grams

For 5531 :

- 8 pcs of 15 grams
- 8 pcs of 45 grams
- 8 pcs of 90 grams

Impact Tester

Light-Duty Impact Tester

Used with materials that can be damaged or penetrated by small impact forces such as products mildly abused in households, offices or labs through years of normal use. Measures impact resistance of plastics and other materials.

- 2 lb steel cylindrical impacter with 1.27 cm (0.5 in) diameter round-nosed end
- Tolerance of ± 56.7 g (± 2 oz); capacity 908 g (2 lbs)
- Graduated 40.6 cm (16 in) guide tube
- Maximum force of 28 inch-pounds
- 1.43 cm (0.563 in) diameter hole in the base allows deformation of thin specimen panels



Top of tube is not shown

Light-Duty Impact Tester



Ordering Information

Cat. No.	Description
1115	Light-Duty Impact Tester

Comes complete with:

- Basic plate
- Guide tube with collar
- Scale in inches
- Weight
- Impact tester
- Operating instructions

Technical Specifications

Scale	Weights included	Dimensions	Net Weight	Shipping Weight
English	0.9 kg (2 lbs)	64 x 25 x 25 cm (25 x 10 x 10 in)	3.4 kg (7.5 lbs)	4.1 kg (9.0 lbs)

Accessories

Cat. No.	Description
1187	Strike Plate
1188	Falling Weight 2 lbs, for 1115
1189	Falling Weight 4 lbs, for 1115
1191	Falling Weight 0.5 lbs, for 1115
1192	Guide Tube, for 1115

BYK-Gardner ISO Impact Tester

Used for testing impact resistance of coatings on metal substrates. In accordance with ISO standard, the test panel is fixed on the die using a clamping device, so that the panel surface outside the test area is not affected by the rapid deformation caused by the falling weight.

- Anodized guide tube with a scale in inches and mm
- Tolerance for ISO falling weights ± 1 g
- Maximum falling weight 2 kg
- Exchangeable falling weights and dies
- Maximum lift distance 100 cm

Impact Tester

The impact tester consists of a solid base stand with a guide tube support. The guide tube has a slot that directs a cylindrical weight that slides up and down with the use of a collar that fits into the weight. Graduations are marked along the slot to facilitate reading where the weight is dropped. The base of the instrument includes a die support. The weights have built-in steel balls that provide different geometrical configurations. It is important that the ball diameter fits into the die to prevent shearing the test samples at the inner rim of the die. In order to limit the indentation depth of the falling weight, distance rings of different thickness can be fitted. Also, different weights can be used.

Note: Please order the correct accessories on the following page to comply with standards

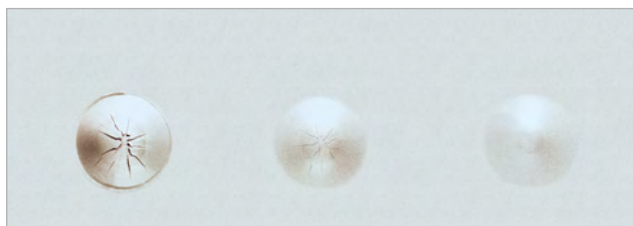

Standards

ISO	6272-1
-----	--------

Ordering Information

Cat. No.	Description
5512	ISO Impact Tester

Comes complete with:

Basic plate with clamping device
Guide tube with collar
Scale in mm and inch

Note: Die and falling weight must be ordered separately

Technical Specifications

Scale	Dimensions	Weight with guide tube
Metric, English	127 x 25 x 25 cm (50 x 10 x 10 in)	9.4 kg (20.7 lbs)

Accessories for ISO 6272-1 and DIN 55669 for 5512

To follow this method, please order the falling weight and the die listed below, in addition to the impact tester from the previous page. Additional weights can also be purchased.



Ordering Information

Cat. No.	Description
5532	Falling Weight 1kg, for 5512
5525	Die, for 5512
5527	Added Weight 1kg, for 5512

Accessories

Extended description
For Ball diameter 20 mm; With lifting pin; for DIN
For Cat. No. 5532; For ball diameter 20 mm; Inner diameter 27 mm
For Cat. No. 5532; 1 kg; Attachable to falling weight



Ordering Information

Cat. No.	Description
5533	Set of Distance Rings, for 5512

Accessories

Extended description
Use to limit the indentation depth of the falling weight from 2 mm to 10 mm

Accessories for ASTM D 2794 for 5512

Impact Tester 5512 does not fully comply with ASTM D 2794. For users that want to continue with using the 5512 for the ASTM method the following accessories are available.



Ordering Information

Cat. No.	Description
5520	Falling Weight 2 lbs, 0.5 in, for 5512
5522	Falling Weight 2 lbs, 0.6 in, for 5512
5521	Large Die 0.5 in, 5512
5528	Small Die 0.5 in, 5512
5523	Large Die 0.6 in, 5512
5529	Small Die 0.6 in, 5512
5526	Added Weight 2lbs, for 5520/5522

Accessories

Extended description
Ball diameter 12.7 mm (0.5 in); With lifting pin
Ball diameter 15.9 mm (0.625 in); With lifting pin
Inner diameter \varnothing 17 mm (0.7 in); for ball diameter 0.5 in
Inner diameter \varnothing 13.9 mm (0.55 in); for ball diameter 0.5 in
Inner diameter \varnothing 21.2 mm (0.83 in); for ball diameter 0.625 in
Inner diameter \varnothing 16.3 mm (0.63 in); for ball diameter 0.625 in
For Cat. No. 5520 and 5522; 2 lbs; Attachable to falling weight

Heavy-Duty Impact Tester

This impact tester has gained wide acceptance in testing the impact resistance of many types of coatings from paints to varnishes to tough plated, plastic or laminated coatings. It is also widely used to establish quality control standards for resistance to impact surface damage and penetration of many construction materials including plastics, resins, fiberglass, sheet metals, and plywood.

Two models are available:

English Model

- Two and four pound weights included
- Maximum allowable force of 80 and 160 inch-lbs
- Round nose punch, 0.625 in diameter
- Guide tube 40 in
- Die inside diameter 0.64 in

Metric Model

- One and two kilogram weights included
- Maximum allowable force of 100 and 200 kg-cm
- Round nose punch, 1.59 cm diameter
- Guide tube 100 cm
- Die inside diameter 1.63 cm

Standards

ASTM D 2794, D 3029,
D 4226, D 5420

ISO 6272-2

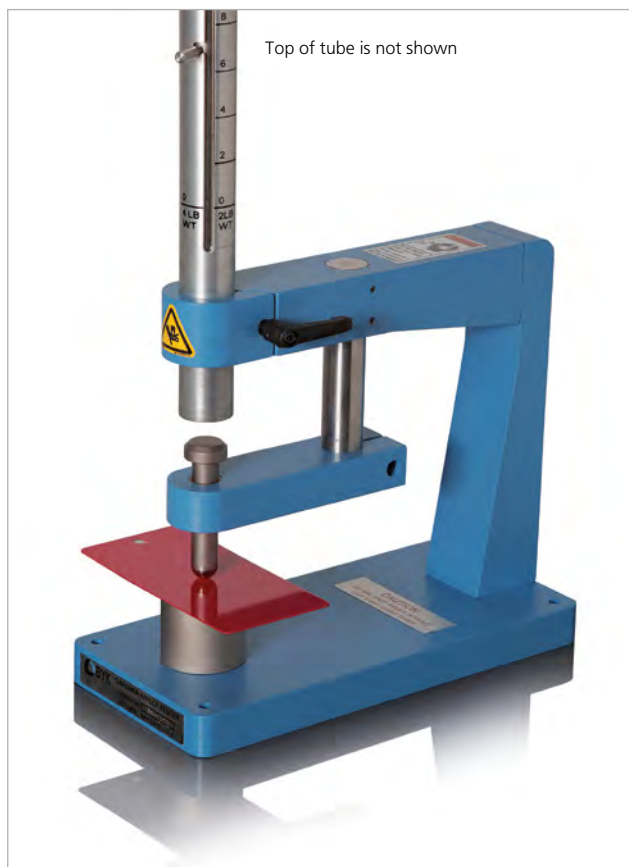

Heavy-Duty Impact Tester 1120



Ordering Information

Cat. No.	Description
1120	Heavy-Duty Impact Tester, English
5545	Heavy-Duty Impact Tester Metric

Comes complete with:

Anvil
Guide tube with collar
Scale in inch or cm
Weight(s); Die
Punch (Tup)
Operating instructions

Accessories for 1120 impact tester

Cat. No.	Description
1240	Falling Weight 2 lbs, 1120/5545
1241	Falling Weight 4 lbs, 1120/5545
1231	Lift Screw, 1120
1243	Ball Punch 0.625 in, 1120
1264	Die 0.640 in, 1120/5545-5547
1248	Guide Tube, 1120
5542*	Base Assembly, 1120, 5545

Note: * The Base Assembly set contains: base, anvil, arm, and arm support

Technical Specifications

Scale	Weights included	Dimensions	Net Weight	Shipping Weight
English	0.9 kg & 1.8 kg (2 lbs & 4 lbs)	127 x 14 x 29 cm (50 x 5.5 x 11.5 in)	10.4 kg (23 lbs)	15.9 kg (35 lbs)
Metric	1 kg & 2 kg (2.2 lbs & 4.4 lbs)	127 x 14 x 29 cm (50 x 5.5 x 11.5 in)	10.4 kg (23 lbs)	15.9 kg (35 lbs)

Note: Sample thickness maximum is 12.7mm (0.5 in)

Accessories for 5545 impact tester

Cat. No.	Description
5539	Falling Weight 500 g, 1120/5545
1249	Falling Weight 1 kg, 1120/5545
1250	Falling Weight 2 kg, 1120/5545
5538	Guide Tube, 5545
5543	Label 0 - 100 kg-cm
5544	Label 0 - 200 kg-cm

Additional accessories available - please call our applications department for further information

SPI Modified Impact Tester (Extra Heavy-Duty)

This impact tester was developed in cooperation with the Society of the Plastic Industry (SPI) for evaluating impact resistance of rigid sheets of PVC (30-60 mils thick) and other plastics and materials exceeding the 160 inch-pounds limit of the Heavy-Duty Impact Tester (1120).

- Graduated 102 cm (40 inch) guide tube with included 8 lb weight
- Redesigned arm on the base allows the impact tester to be used in tough applications
- Stop position clamp ensures you can always test at the same height, if needed
- Optional alignment tool helps to ensure the impact tester is lined up correctly (order separately below)
- Maximum force of 320 inch-pounds with 8 lb weight
- 12.7 mm (0.500 in) diameter punch
- 16.3 mm (0.640 in) die
- Guide tube OD 44.5 mm (1.75 in), ID 39.6 mm (1.56 in)

Standards

ASTM	D 2794, D 3029,
	D 4226, D 5420, G14



SPI Heavy-Duty Impact Tester 5513



Ordering Information

Cat. No.	Description
5513	SPI Heavy-Duty Impact Tester

Comes complete with:

Basic plate; Guide tube with collar; Scale in inches-pounds, Weight (8lb); Die; Punch (Tup); Operating instructions

Accessories

Cat. No.	Description
1190	Calibration Tool, for 5513
1260	Falling Weight 8 lbs, for 5513
1231	Lift Screw
1220	Ball Punch 0.50 in
5514	Anvil, 3.0 in. ID, for 5513
1264	Die 0.64 in
5516	Sampe Platform, for 5513
1266	Guide Tube, for 5513
1269	Base Plate
1271	Arm
1275	Base, for 5513
1274	Stop Position Clamp, for 5513
5515	Die Adapter, 1.25 in. ID
5517	Anvil Kit, includes 5515 & 5516
5519	ASTM G14 Accessory Kit*

*Note: G14 Accessory Kit includes a base with pipe holder, 3 lb falling weight with 5/8 inch diameter indenter.

Technical Specifications

Scale	Weights included	Dimensions	Net Weight	Shipping Weight
English	3.6 kg (8 lbs)	127 x 15 x 33 cm (50 x 6 x 13 in)	16.8 kg (37 lbs)	19.5 kg (43 lbs)

Note: Maximum sample thickness is 12.7 mm (0.5 in)

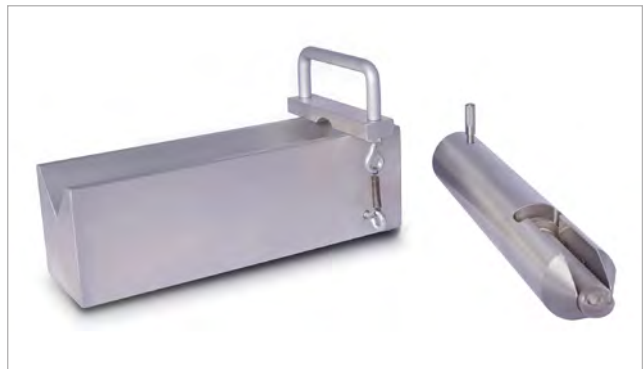

ASTM G14 Accessory

ASTM Methods for Impact Testers

The various ASTM methods for impact testers require certain punches and dies that are not normally included with the impact testers. Please refer to the ASTM standards below to inquire about the parts needed to do the test.

ASTM D 2794 – Impact Resistance of Coatings

Method	Die	Punch	Instrument used	Die	Punch	Additional parts needed to meet the method
ASTM D 2794	0.64 in	0.625 in	1120	0.64 in	0.625 in	No additional part needed
	0.64 in	0.50 in	5513	0.64 in	0.500 in	No additional part needed
			1115	hole is 0.563 in	0.500 in	No additional part needed

ASTM D 3029 – Impact Resistance of Flat Rigid Plastic (Method G)

Method	Die	Punch	Instrument used	Die	Punch	Additional parts needed to meet the method
GB	1.25 in	0.625 in	1120	anvil without die is 1.25 in	0.625 in	No additional parts needed
			5513	anvil without die is 1.25 in	not included	1243 needed
GC	0.64 in	0.625 in	1120	0.64 in	0.625 in	No additional parts needed
			5513	0.64 in	not included	1243 needed

Note: An 8 lb weight is available for the 1120
2 and 4 lb weights are available for the 5513

General requirements:

2, 4, or 8 lb weight
40 in guide tube

ASTM D 4226 – Impact Resistance of PVC

Method	Die	Punch	Instrument used	Die	Punch	Additional parts needed to meet the method
ASTM D 4226	0.64 in	20°, 0.125 in	1120	0.64 in	not included	1224 needed
		radius (C.125)				8 lbs weight 1203 needed
	0.64 in	0.500 in (H.25) diameter	5513	0.64 in	0.500 in	No additional parts needed

General requirements:

8 pound weight
40 in guide tube

ASTM D 5420 – Impact Resistance of Flat Rigid Plastic by means of Gardner Impact

Method	Die	Punch	Instrument used	Die	Punch	Additional parts needed to meet the method
GA	3.00 in	0.625 in	5513	anvil without die adapter	not included	1243 needed
GB	1.25 in	0.625 in	1120	anvil without die is 1.25 in	0.625 in	No additional parts needed
			5513	anvil without die is 1.25 in	not included	1243 needed
GC	0.64 in	0.625 in	1120	0.64 in	0.625 in	No additional parts needed
			5513	0.64 in	not included	1243 needed
GD	3.00 in	0.500 in	5513	anvil without die adapter	0.500 in	No additional parts needed
GE	0.64 in	0.500 in	1120	0.64 in	not included	1220 needed
			5513	0.64 in	0.500 in	No additional parts needed

Note: An 8 lb weight is available for the 1120
2 and 4 lb weights are available for the 5513

General requirements:

2, 4, or 8 lb weight
40 in guide tube

Accessories for Impact Testers 1120, 5545, 5513

These items are not included with the instrument and may be needed for a specific ASTM method, or to expand the inch-lb capacity of the impact tester. Other items may be available on special request.

Dies for 1120, 5545, 5513



Accessories

Cat. No.	Description
1210	Die 0.313 inch Inner Diameter
1211	Die 0.563 inch Inner Diameter
1264	Die 0.640 inch Inner Diameter
1212	Die 1.00 inch Inner Diameter
1213	Die 1.25 inch Inner Diameter

Punches for 1120, 5545, 5513



Accessories

Cat. No.	Description
1243	Ball Punch 0.625 inch Diameter
1220	Ball Punch 0.500 inch Diameter
1221	Ball Punch 0.375 inch Diameter
1222	Ball Punch 0.250 inch Diameter
1223	Ball Punch 0.125 inch Diameter
1224	20° Punch, 0.125 inch radius (for ASTM D4226)
1225	Detachable Tip Punch, 1 inch Radius
1226	Detachable Tip Punch, 1 inch Diameter
1227	3-sided Tip Punch (Boeing BSS7271)

Weights for 5513 ONLY



Accessories

Cat. No.	Description
1207	Weight 0.5 lbs, for 5513
1208	Weight 1 lbs, for 5513
1201	Weight 2 lbs, for 5513
1209	Weight 3 lbs, for 5513
1202	Weight 4 lbs, for 5513
1214	Weight 6 lbs, for 5513
1260	Weight 8 lbs, for 5513
1215	Weight 10 lbs, for 5513
1204	Weight 12 lbs, for 5513
1206	Weight 16 lbs, for 5513

Weights for 1120 & 5545 ONLY



Ordering Information

Cat. No.	Description
1219	Weight 0.5 lbs, for 1120/5545
1218	Weight 1 lbs, for 1120/5545
1240	Weight 2 lbs, for 1120/5545
1241	Weight 4 lbs, for 1120/5545
1242	Weight 6 lbs, for 1120/5545
1203	Weight 8 lbs, for 1120/5545
1252	Weight 100 g, for 1120/5545
1253	Weight 300 g, for 1120/5545
5539	Weight 500 g, for 1120/5545
1249	Weight 1 kg, for 1120/5545
1250	Weight 2 kg, for 1120/5545

Additional Parts for 1120 & 5546



Ordering Information

Cat. No.	Description
1228	Scale 4 lbs weight
1229	Scale 2 lbs weight
1230	Scale 8 lbs weight
1274	Stop Position Clamp, for 5513

Info!

For technical assistance please call our Applications Department

BYK-Gardner "Coverall" Bend and Impact Tester

Used to test both flexibility and impact resistance. By simply reversing the impactor, the instrument can evaluate the flexibility of can-stock coating during double seaming and to test its impact resistance in handling.

- Tests both flexibility and impact resistance
- Graduated (inches) guide tube
- Maximum force of 160 inch-pounds

Procedure: Impact Test

For impact studies, the top block is leveled with the plug removed exposing a 1.43 cm (0.563 in) hole. The 1.27 cm (0.50 in) diameter, round-nosed end of the 4 lb weight may now be dropped from any height along the graduated scale on the guide tube from 0 to 160 inch-pounds.

Procedure: Bend Test

To make a bend test, the coated panel 3" x 4" (0.048" thickness) is first bent 180° over the 1/8" rod. The bent panel is placed between the parts of the hinge. Then the impact tool, flat face down, is dropped from any desired height onto the upper part of the hinge. The cylindrical fold in the panel is squeezed into a conical shape.



Standards

ASTM D 3281

Technical Specifications

Scale	Weights included	Dimensions Base Unit	Net Weight	Shipping Weight
English	4 lbs	127 x 25 x 25 cm (50 x 10 x 10 in)	8.2 kg (18 lbs)	11 kg (24 lbs)



Ordering Information

Cat. No.	Description
1125	Coverall Bend - Impact Tester

Comes complete with:

Base with arm support; Guide tube with collar; Scale in inches; Four pound weight; Punch; Operating instructions

Accessories

Cat. No.	Description
1574	Hinge Plate, for 1125
1573	Anvil, for 1125
1568	Guide Tube
1571	Weight 4 lbs, for 1125
1231	Lift Screw
1128	Weight 2 lbs, for 1125

Mechanical Cupping Tester

The BYK-Gardner Mechanical Cupping Tester is designed to test the elongation and deformability of lacquers and protective coatings applied to metal substrates. The punch is applied under pressure to the uncoated side of the test panel. The panel is held in place by a clamping ring. Two test procedures can be performed the "Predetermined depth" (go/no go) or "Minimum depth required to cause failure".

- Ergonomic design to save counter space
- Two hand crank operation for ease of operation
- Precision gearbox to provide reproducible results
- Chrome steel spherical punch
- Illuminated 2.5X magnifier on a pivoting arm
- Battery powered with auto-off feature
- LCD display showing indentation depth of 0.01 mm resolution

Test Panels

The recommended test panel size is a minimum of 70 mm (2.75 in) square with a maximum size of 100 mm (3.9 in) wide and 150 mm (6.0 in) high. For burnished steel the minimum thickness is 0.3 mm (0.01 in) to a maximum of 1.25 mm (0.05 in). The maximum tensile strength of a 1.25 mm thick panel can not exceed 280 N/mm². For aluminium panels the maximum thickness is 3 mm (0.12 in).



Standards

BS	3900
DIN	53166, 53232
ISO	1520,
JIS	K 5600-5-2, B 7729



Ordering Information

Cat. No.	Description
5405	Mechanical Cupping Tester
5406	Indenter, 5405
5407	Magnifier, 5405
5408	Zero Plate, 5405

Comes complete with:

Mechanical cupping tester
indenter
zero plate
magnifier glass
alkaline batteries 2 D size, 4 AA size
Operating instructions

Technical Specifications

Spherical Punch	ø 20 mm (ø 0.8 in)
Full Travel	0.00- 20.50 mm (0.0 - 0.81 in)
Accuracy	±0.05mm (0.002 in), full range
Calibrated Range	-0.5 to 20.5 mm (0.02 - 0.81 in)
Gearing	1 revolution of handle moves punch 0.2mm under load
Display	LCD 4-digit
Dimensions	420 x 350 x 500 mm (16.5 x 13.8 x 19.7 in)
Weight	16 kg (35.2 lb)
Power	Main 2 alkaline D cells; Magnifier 4 alkaline AA cells
Operating Temperature	+15 - +35 °C (59 - 95 °F)

Cupping Tester

The BYK-Gardner cupping tester has been designed for determining the elongation and deformability of single- and multiple-layer systems on metal substrates.

- Electrohydraulic drive for highly reproducible results
- Easy to use eccentric clamping ring
- C-opening accepts large and small test panels
- For test panels with a thickness of up to 1.5 mm (0.06 in)
- Uniform cupping speed of 0.2 mm/s (0.008 in/s)
- 3 keys to control all functions
- Digital display, resolution 0.1 mm

Stereo Microscope for cupping tester

This stereo microscope with illumination and brightness control is designed to observe the paint surface during the test.

- 2x and 4x magnification
- 3D-image with shadowless illumination
- Ergonomic working position

Procedure:

- Insert the test panel into the C-opening of the instrument
- Clamp in the sample firmly
- Start cupping and simultaneously observe the process through the stereo-microscope
- Apparatus presses the cap of the spherical punch into the test panel at a uniform speed (0.2 mm/s)
- As soon as the first cracking is visible, stop the movement of the punch
- Read the cupping depth on the digital display and reset the punch
- Always carry out 3 tests for each sample



cupping tester with stereo microscope

Standards

ISO	1520
Erichsen Cupping	EC

Technical Specifications

Spherical Punch	ø 20 mm (ø 0.8 in)
Sheet Holder	ø 33 mm (ø 1.3 in)
Die	ø 27 mm (ø 1.06 in)
Voltage	230 V / 50 Hz or 115 V / 60 Hz; built-in switch
Current Indicator	max. 4 A (230 Volts)
Dimensions	650 x 280 x 600 mm (26 x 11 x 24 in)
Weight	65 kg (143 lbs) (incl. microscope and packing)



Ordering Information

Cat. No.	Description
5400	Automatic Cupping Tester
5411	Stereo Microscope, 5400

Comes complete with:

Cupping tester
Connection cable and plug
Operating instructions

Stereo Microscope for cupping tester:

Stereo microscope
Microscope rest and illumination
Operating instructions

Note: Stereo microscope must be ordered separately

Cylindrical Mandrel Tester

Bending coated sheet metal over a defined radius is an indicator of the elongation and adhesion of a paint film at bending stress. BYK-Gardner offers two types of mandrel bending testers – a cylindrical mandrel and a conical mandrel.

ISO Version

This mandrel is used for simple and quick testing of the flexibility of a coating by bending a coated panel over a rod of known diameter and then examining the coating for cracking, flaking, or other damage.

- Made of anodized aluminum
- 12 mandrels of stainless steel
- Panels up to 65 mm (2.56 in) width can be tested
- Rod diameter sizes: 2, 3, 4, 5, 6, 8, 10, 12, 16, 20, 25, 32 mm

ASTM Version

- "V" shaped cuts for holding a mandrel during a test
- Slots at the base of the frame hold the rods not in use
- Panels up to 14 cm (5.5 in) x 22 cm (9.0 in) can be tested
- Rod diameter sizes: 1/8, 3/16, 1/4, 5/16, 3/8, 7/16, 1/2, 3/4, 1.0 inch
- Compliant with ASTM D522 Method B

Procedure

- Apply the paint film on sheet metal strips
- Coat and dry film carefully to ensure reproducible results
- For testing, uniformly bend the coated samples over the bending mandrels within 1-2 sec at 180 degrees
- Starting with the largest bending radius, the test is continued until reaching the bending radius at which the film shows cracks



Standards

ASTM	D 522
DTMS 141a	Method 2012 Method 6051 Method 6221 Method 6223
ISO	1519



Ordering Information

Cat. No.	Description
5710	Cylindrical Mandrel Set, ISO
1412	Cylindrical Mandrel Set, ASTM

Comes complete with:

Cylindrical Mandrel Bending Tester, ISO Version:
Set of 12 SS rods from 2 mm to 32 mm; Frame; Operating instructions
Cylindrical Mandrel Set, ASTM Version:
Set of 9 SS rods from 1/8 in to 1.0 in, Frame, Operating instructions

Technical Specifications

	Dimensions	Net Weight	Shipping Weight
	38 x 14 x 15 cm (15 x 5.5 x 5.9 in)	4.4 kg (9.7 lbs)	5.0 kg (11 lbs)
	300 x 180 x 180 mm (12 x 7 x 7 in)	2.3 kg (5.0 lbs)	3.6 kg (8.0 lbs)

Note: Maximum panel thickness – 0.79 mm (0.031 in) for 5710 Cylindrical Mandrel

Conical Mandrel Tester

The varying mandrel diameter (3.2 mm - 38.1 mm, 1/8 to 1.5 inches) stretches a coating through a gradient of distension, allowing precise determination of adhesion characteristics.

- Aluminum panels up to 20.3 cm (8 inches) wide and 1.6 mm (.063 inches) thickness can be tested
- Steel panels up to 20.3 cm (8 inches) wide and 0.8 mm (.031 inches) thickness can be tested
- Durable sturdy stainless steel mandrel
- Built-in ruler to measure the failure point
- Compliant with ASTM D522 Method A

Procedure

- Carefully cover test panel with paper between mandrel and draw bar, and clamp the panel
- Fold the test panel around the cone by using the manually operated arm that is pivoted at the ends of the axis of the cone
- Bend uniformly at 180 degrees within 15 seconds
- Remove panel and examine the coating for cracks
- Mark the point at which the cracking stops and measure the distance from the farthest end of the crack to the small end of the mandrel
- Appropriate calibration curves also permit determination of the elongation values of the paint film

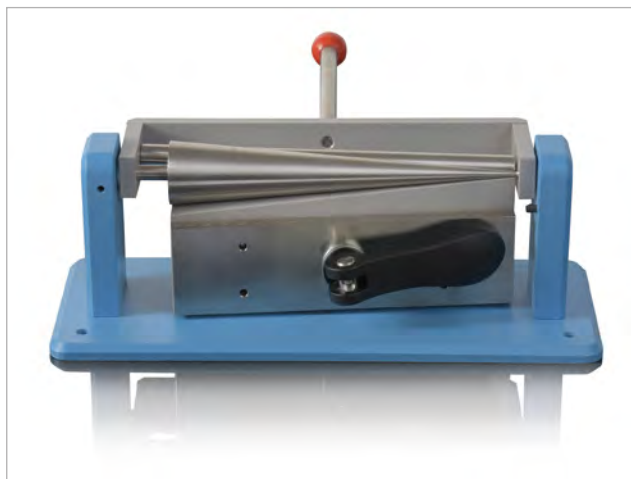

Standards

ASTM	D 522, D 1737
ISO	6860



Ordering Information

Cat. No.	Description
5751	Conical Mandrel Tester

Comes complete with:

Stainless Steel Conical Mandrel
Operating instructions

Technical Specifications

Net Weight	Dimensions	shipping Weight
4.1 kg (9.0 lbs)	510 x 150 x 180 mm (20 x 6 x 7 in)	5.5 kg (12.0 lbs)

Publications Books

Paint and Coating Testing Manual Gardner-Sward Handbook, 14th Ed.

The Paint and Coating Testing Manual is the perfect guide for the coating technologist. This guide provides in-depth information on test procedures, standards, and environmental regulations that can help everyone from the newcomer to the experienced researcher.

- Current industry regulations
- The main polymeric species, colorants, special pigments, extenders, and additives used in the coatings industry
- Testing instruments used in the industry
- Analysis of paint and paint-related defects
- ASTM and other International standards

Paint & Coating Testing Manual Contents:

- Part 1: Regulations
- Part 2: Naturally Occurring Materials
- Part 3: Synthetic Materials
- Part 4: Plasticizers
- Part 5: Solvents
- Part 6: Pigments
- Part 7: Additives
- Part 8: Physical Characteristics of Liquid Paints and Coatings
- Part 9: Films for Testing
- Part 10: Optical Properties
- Part 11: Physical and Mechanical Properties
- Part 12: Environmental Resistance
- Part 13: Specific Product Testing
- Part 14: Analysis of Paints and Paint Defects
- Part 15: Instrumental Analysis
- Part 16: Specifications

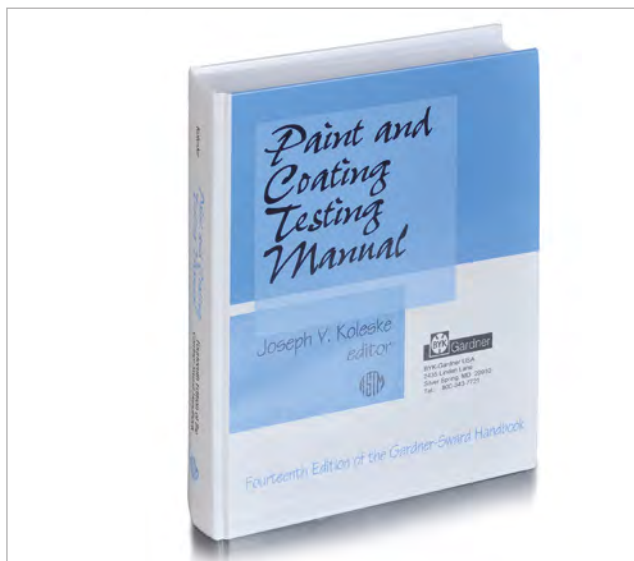

Ordering Information

Cat. No.	Description
9095	Paint Testing Manual

The Measurement of Appearance, 2nd Edition by Richard Hunter, Richard Harold

This second edition identifies the appearance attributes of objects and the methods for measuring them. The primary premise here is that object appearance involves not only color, but also gloss, luster, and translucency.

The first part draws from the fields of physiology and psychology and considers the eye-brain combination and the way it receives and interprets light signals. The second part deals with the numerical scales used to measure object appearance. The third part covers instruments for the measurement of the attributes of object appearance, their principles of design, and a survey of the major ones in use.

- In-depth analysis and discussion on total appearance measurement
- Great reference resource for the color research scientist or the QC technician on the production line

Table of Contents

- 1 Attributes of the Appearance of Objects
- 2 Light Sources and Illumination
- 3 Interaction of Objects with Light
- 4 The Human Observer and Visual Evaluation of Appearance
- 5 Psychophysical Scales for Appearance Measurement
- 6 Scales for Gloss and Other Geometric Attributes
- 7 The CIE Standard Observers
- 8 Uniform Color Scales
- 9 Scales for the Measurement of Color Difference
- 10 Special Scales for White Colors
- 11 Other Scales for Color Identification
- 12 Instrument Classification and Components
- 13 Instruments for the Geometric Attributes of Appearance

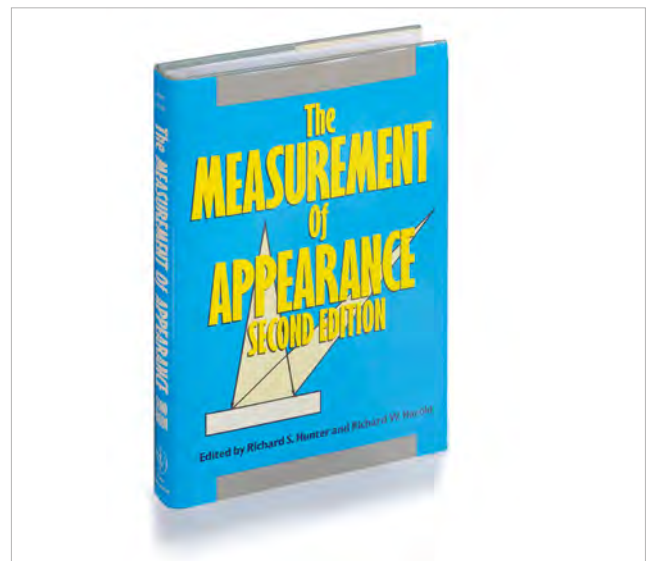

Ordering Information

Cat. No.	Description
9096	The Measurement of Appearance

Introduction

Microscopes have been used for centuries as visual aides to assess small structures. BYK-Gardner has several products that use microscopes either as an integrated component of the instrument or as a stand-alone product. This section summarizes the stand-alone microscopes that are currently available.

Digital Microscope

An electronic image available on a personal computer has opened new opportunities to evaluate surface quality and document results. Many physical property tests are evaluated by visual analysis: cross-cut adhesion, impact resistance, flexibility, abrasion resistance, and scratch/mar. An electronic image can be used to provide a more comprehensive evaluation and documentation of the test results.

A digital microscope combined with image analysis software has created a new line of analytical tools to assess appearance. The Print and Paper Industry has developed several tests to maintain product quality. Assessment of the printing process and the paper's appearance has well defined measurement parameters. Digital microscopes offer a comprehensive analytical analysis for an objective evaluation.

Traditional Microscope

BYK-Gardner offers two microscope designs specific for physical property testing. The microscope for the Automated Cupping Tester has a unique design that attaches to the Cupping Tester. The microscope provides a detailed observation of the test panel. The Buchholz Indentation hardness tester also requires a specific microscope design to measure the indentation length. The microscope incorporates a graduated scale for a precise assessment.



MICROSCOPES

DPM 300

Digital Pocket Microscope

The DPM 300 Digital Pocket Microscope offers varying magnification up to 200x suitable for most quality inspection work. The microscope features integrated white LED illumination which can be turned on and off depending on the application. The DPM contains a high-resolution color camera which provides crisp, clear images. To capture an image simply press the silver button on the microscope. The microscope can be used for many applications, such as print quality, paper structure, coatings, textiles, plastics, etc. By using a special polarization filter, the DPM 300 is the right choice when working with high glare materials such as coatings, plastics and metals.

DPM 300 Digital Pocket Microscope Features:

- High resolution CMOS-camera offering clear images
- Very Portable and easy to use
- USB cable connection for data transfer
- Auto Gain function to adjust lightness differences
- 8 LED Illumination for crisp images
- Capture button to save an image
- Polarization Filter for a better view on high glare materials

DPM 300 Software Features:

- Database function to store images and test results
- DPM Standard Measurement: Region Tool, Distance Tool, Angle Tool, Circle Tool, Area Tool, Step Distance Tool
- Special software for coatings to analyze cross-cut, byko-cut (V-Cut), Buchholz-Indentation, Hardness- and Impact testing
- Automatic Image Analysis: Dots, Lines, Text, Barcodes, Shapes, Satellites, Voids, Graininess, Mottling, Missing Dots etc.
- Calibration function for the camera with calibration sheet



Ordering Information

Cat. No.	Description
9093	DPM 300 Digital Pocket Microscope

Comes complete with:

DPM 300 Instrument
DPM Software (1 License for 2 installations)
Metal Cup
Operating manual (digital on CD English)
Protective bag
Polarization Filter

Technical Specifications

	Resolution	Magnification	Power supply
	1280 x 1024 Pixel ($\approx 1.3 \mu\text{m}$ per pixel)	200x	USB Port (5 VDC)
Interface		USB 2.0 Cable 2 m	
Dimensions		$\varnothing 32 \text{ mm} \times 114 \text{ mm}$	
Weight		115 gr.	

Typical Application

Print and Paper Industry

Dots & Satellites

The "Dot" function determines the number of dots, average area size (mm²) and their covered area (%) together with the corresponding data for detected satellites inside the defined region.

Lines

The "Line" function will automatically characterize the leading and trailing edges of the line with respect to the angle, blurriness, raggedness together with the width (mm) and contrast of the line according to the ISO 13660 specifications.

Shapes

The "Shape" function will automatically characterize the area (mm²), width (mm), height (mm) and perimeter (mm) of the selected object inside the defined region.

Voids

"Voids" are detected when a solid black area has white, unprinted spots in it. The voids must be within the size limits defined by the voids parameter. The DPM software will count the number of detected voids inside the selected area.

Mottling & Graininess

This function characterizes how evenly a uniform printed area appears to the human eye.

For "Graininess", the high frequency variations are characterized from sub-images (tiles) of different sizes from 0.042 mm (0.0018 mm²) up to 1.02 mm where the smaller tiles will divide the defined region into more sub-images (counts). The variation between the sub-images of a particular grid size (Grid) is then calculated as the standard deviation (S.D). Finally the different standard deviations are averaged into one single "Total" number.

The "Mottling" describes the low frequency pattern and here only a single grid size of 1.27 mm is used to calculate the variation. According to ISO 13660, the region must be at least 161 mm² (12.7 mm x 12.7 mm) in which case the DPM instrument must be installed on a stand to obtain 100 tiles for mottling.

Paint and Coating Industry

Destructive Film Thickness

The V-shaped cut from the byko-cut can be easily stored as an image with film thickness info in mm. The width from the cut is automatically recalculated to the film thickness of the coating if you select the right cut-Angle (45°, 26.5°, 5.8°).

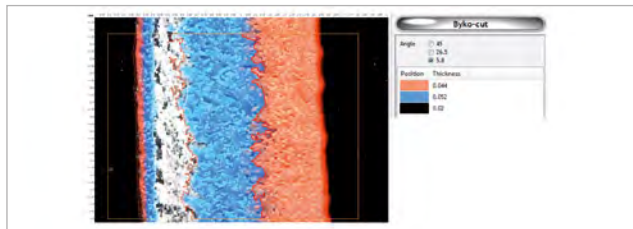

Adhesion Test

Evaluation of the adhesion of a coating. The DPM Paint Software views the cross-cut on the screen and evaluates the defects of the edges, lines, shapes and defects of the image according to DIN EN ISO 2409.

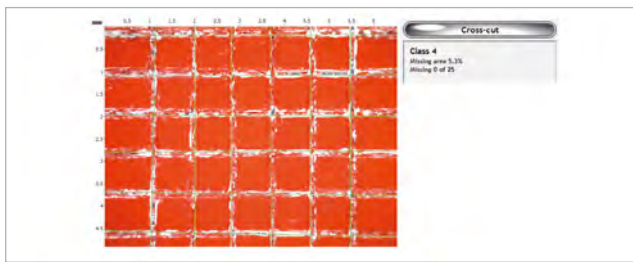

Buchholz Indentation

The indentation test as per Buchholz is a reliable test method for evaluation of indentation resistance of plastic deformable coatings. The indentation length is automatically measured from the software and can be converted with the "Buchholz Indentation Table".

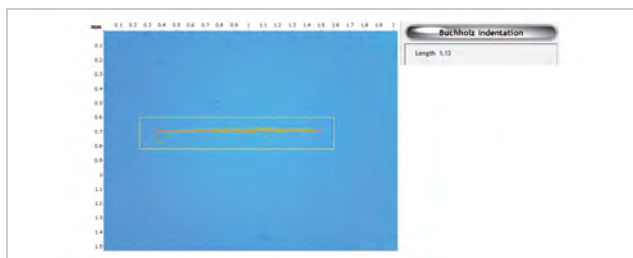

Elasticity and flexibility

The result of the impact or cupping test is automatically calculated in length and average of the rings by the paint software. The impact, cupping and mandrel bending test result can be saved as a digital image.

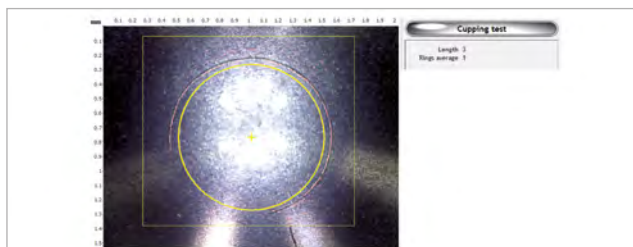

Precision Microscope

This precision microscope usually is used to measure indentation length.

- 20x magnification
- inclusive light source

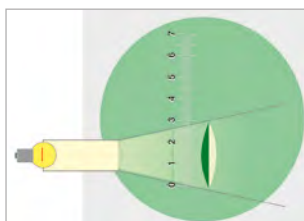

Ordering Information

Cat. No.	Description
5824	Precision Microscope

Technical Specifications

Comes complete with
20x magnification with graduated scale to measure indentation length, incl. light source; Weight: 0.8 kg

Surface Tension

Pocket Goniometer PGX+

The Pocket Goniometer PGX+ is a contact-angle goniometer to check surface properties for contamination, adhesion and printability of metals, polymers, glass, coatings etc. The PGX+ is a portable device that is placed directly onto the sample surface eliminating sample preparation. The instrument has a video camera and dosing pump to precisely deliver a 0.5 µl droplet. The PGX+ is connected directly to a laptop or PC using a USB port. The camera image can be analyzed for static contact angle, dynamic contact angle, surface tension, and surface energy.

- Surface energy determination using more than one probing liquids
- Surface tension measurement from droplet shape - tangent angle analysis
- Dynamic contact angle to measure the wetting, absorption, spreading rate properties
- Automatic droplet application for static or dynamic mode
- Portable size for convenient sample measurement



Ordering Information

Cat. No.	Description
1937	Pocket Goniometer PGX+

Comes complete with:

Calibration kit, Spare pump tubing, Droplet dispenser, Software, Carry case

Note: Software for Windows XP, Vista, 7, 8, 8.1, 10 (32 and 64 bit)

Standards

ASTM	D724, D5946
ISO	15989
TAPPI	T458

PG Dosing Unit

The PG Dosing Unit is a stand-alone pump used in unison with the Pocket Goniometer PGX+ to measure contact angle. The PG Dosing unit has disposable syringes for quick change-over of different liquids to conduct surface energy studies. If tacky liquids or hard to clean liquids are used, the disposable syringes save time and expense.



Ordering Information

Cat. No.	Description
1938	PG Dosing Unit

Comes complete with:

5 disposable syringes, 5 Dispensing tips 0.2 mm, 5 Dispensing tips 0.5 mm, 5 Dispensing tips 0.9 mm, Carrying case, Power adapter

Technical Specifications

Preset Droplet Volumes	Programmable volumes	Voltage	Dimensions	Weight
2, 4, 8 µl	0.1 - 20 µl	100 - 240V	160x55x55mm	500 grams



Ordering Information

Cat. No.	Description
1939	Syringe, Disposable
1942	PTFE tubing 1.5/0.2 mm
1943	PTFE tubing 1.5/0.5 mm
1944	PTFE tubing 1.5/0.9 mm
1945	Dispensing tip 0.2 mm
1946	Dispensing tip 0.5 mm
1947	Dispensing tip 0.9 mm

Accessories

Information
100 pieces, 1 ml volume
100 pieces, Length - 250 mm
100 pieces, Length - 250 mm
100 pieces, Length - 250 mm
50 pieces
50 pieces
50 pieces

Document, Analyze and Optimize your Production Cure Process

Is the paint cured at all points of the body?

On a car body we are dealing with parts that have different geometries, thickness and might even have different substrate materials. Heat transfer is dependent on the material, the thickness and the body shape. The goal of the process engineer is to optimize the line speed at the lowest possible temperature.

In the following example the cure performance of an e-coat oven before and after some re-modeling was analyzed. After reconstruction the entire baking process was running a few degrees higher than before the construction. The temperature curves of an A-pillar before and after reconstruction of the e-coat oven are shown in the following graph.

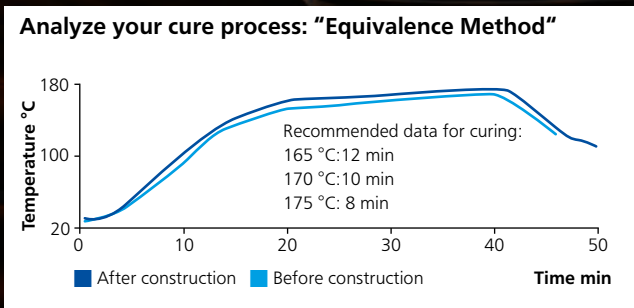

The paint manufacturer's recommended data for curing were as follows:

165 °C 12 min / 170 °C 10 min / 175 °C 8 min

Traditional methods judge a baking process by comparing the paint manufacturer's recommended temperature/time (high reference – low) to the actual production oven data. Based on this traditional cure evaluation 170 °C was only touched and 165 °C was only reached and surpassed for 7 minutes.

Consequently, the conclusion would have been:

"Insufficient curing". Nevertheless, the e-coat showed good sanding properties which means the system was cured. The traditional comparison does not take into consideration that crosslinking already starts at temperatures below the specified low temperature and accelerates at higher temperatures.

The new BYK-Gardner Cure Index calculated by the temp-chart software allows a detailed analysis of all temperature data contributing to the cure process.

› Equivalence time = 15.6 min relative to the reference temperature 170 °C. Consequently, the coating system was completely cured.

The new cure index method objectively proves that a lower temperature bake is absolutely sufficient to guarantee a well cured system.

› Reliable data on cure status allow true optimizing of the cure process: line speed and baking temperature

Reference:

By Dipl. Ing. Eide Wilckens, Porsche AG, JOT, page 66-71, May 1998

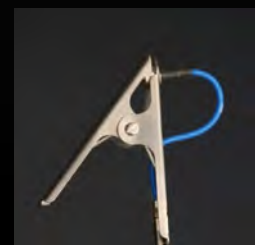

Introduction

Baking Temperature

Today's industrial mass production would not be possible without the use of baked coatings. Drying times (baking times) varying between a few minutes to half an hour are common in the production process.

Today's finishes must meet very high mechanical and appearance QC requirements, including

- Optimum adhesion
- Sufficient elasticity in case of deformation through mechanical stress
- Long-term weather stability, e.g. corrosion resistance
- Gloss and color stability
- Optimum hardness

Optimum curing is the prerequisite for achieving these specifications. The properties and the exact temperature distribution of the oven must be known in order to avoid rejects and ensure consistent quality. Poor curing can lead to failure:

- Insufficient adhesion to the substrate
- Insufficient elasticity to resist mechanical stress
- Insufficient surface hardness
- Premature aging, brittleness and chipping, leading to rust and corrosion
- Discoloration and loss of gloss

Any of these damages can be costly to repair.

The traditional range of baked coating systems has changed considerably with the introduction of environmentally friendly systems. The following types of paint technologies are being used:

- Conventional, solvent borne systems with 50% to 60% organic solvents
- High-solids with 10% to 30% solvents
- Water-borne paint systems
- Powder coatings, 100% solids and 0% solvents

Thermoset coatings (acrylic, polyester, epoxy or alkyd resins) are established finishes for industrial applications.

The right catalysts and amount of heat initiate the cross-linking process among the various components. The result is a compact paint system consisting of polymers, resins, binders and pigments, which is to be chemically resistant and long-lasting.

Paint properties largely depend on cross-linking quality. Today's binders are very sensitive to insufficient cross-linking.

TEMPERATURE

Insufficient cross-linking causes

- Soft films with low hardness
- Poor or no chemical resistance
- Poor weather resistance (UV, SO₂, etc.)

Sufficient cross-linking can result in

- Better adhesion
- Better flexibility
- Better intercoat adhesion
- Increased gloss
- Lower haze values

Over-cross-linking causes

- Increased hardness
- Less flexibility
- Less gloss
- Higher haze values
- Poor adhesion or intercoat adhesion
- Improved solvent resistance
- Yellowing or discoloring
- Less outdoor resistance, especially when subjected to UV radiation

In order to determine the optimal cross-linking parameters of a system, a series of tests must be carried out at different baking temperatures. Minimum and maximum baking temperatures determine the limits of an optimal curing process. In this process, time and temperature can vary. The reaction speed changes with the temperature, but in a non-linear manner. The heat-up speed is another key factor for solvent based and aqueous systems. If the heat-up speed is very high, the solvent evaporates too quickly and pinholes may occur causing poor appearance.

The example below shows three different theoretical temperature profiles with identical curing. Slight temperature changes have a big impact on the curing time.

In the production process the temperature profile will rarely be so simple, since material thickness is never constant and oven temperatures vary due to external influences.

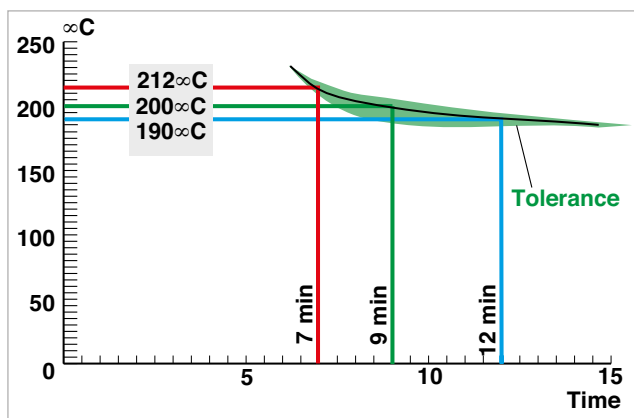

Baking Ovens

Baking properties of new paint systems need to be tested and optimized in the laboratory. This is usually done with a convection oven. The coated test panel is put into the preheated oven for a set time. To this point the process in the laboratory is identical with the process in the production line. This stage in development is very time and labor intensive. Many test panels have to be baked at various temperatures and times. This is the only way to accurately determine the optimum temperature and baking time. In addition, it is difficult to accurately reproduce a constant sample temperature and heat-up speed of the sample using several convection ovens.

gradient-oven

BYK-Gardner offers a well established type of baking oven, the gradient-oven, for better control, higher precision, and production simulation in the laboratory.

The gradient-oven houses a microprocessor-controlled heating bank consisting of 45 heating elements, each equipped with a PT-100 temperature probe. Each element is separately insulated allowing the setting of different temperatures at two adjoining elements.

The coated test panel 560 x 100 mm (22 x 4 inches) is automatically transported onto the heating bank with the help of a sample pressure device guaranteeing quick heat transfer. The heating area is enclosed by a special cover situated approximately 50 mm (2.0 inches) above the test panel.



Comparison of convection ovens with the gradient-oven
Comparison measurements between convection ovens and the gradient-oven show the following profiles.

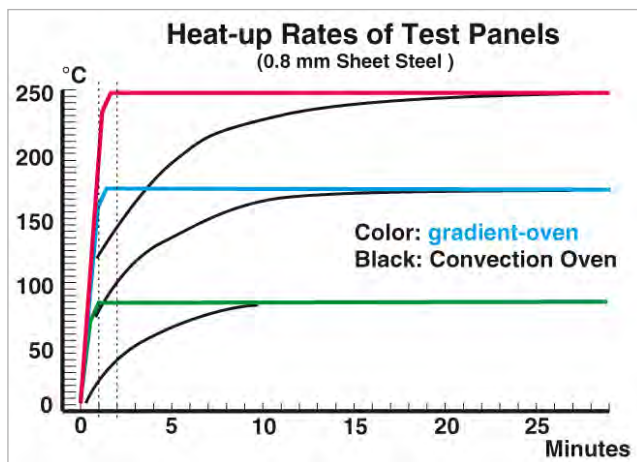

Testing with the gradient-oven provides major benefits:

- QC of color, appearance, and physical properties can be performed with continuous temperature variation on one panel
- Heat-up speed and baking time can be set to simulate production baking conditions
- High accuracy allows reproducible results and avoid repetitive tests
- Major savings in application time, coating materials, number of test panels, and energy
- A panel can be baked with various temperature profiles:
 - constant temperature over the entire panel
 - linear gradients with maximum difference of 100 °C
 - step gradients of different temperatures

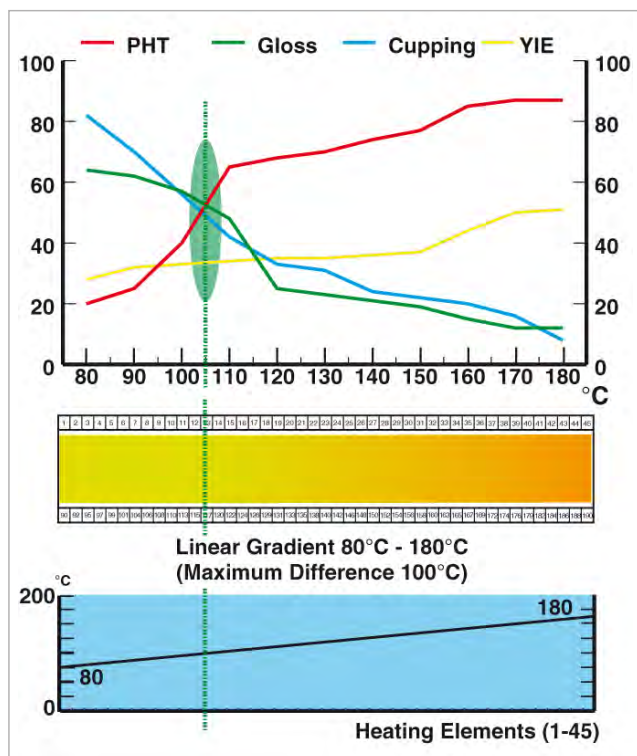

Oven Temperature Recorders

In order to gain maximum output of a production line the baking oven must fit perfectly into the process. The method of heating the oven (gas, oil, electricity) and air distribution as well as the assembly line speed are parameters which must be taken into account for the control of the oven. The oven temperature is influenced by power variations and oven construction. The object temperature depends on parameters such as material, material thickness, the place of suspension (top, middle, bottom), and assembly line speed. It is essential to check whether an oven works properly to ensure right heat-up of an object, guaranteeing optimal cross-linking and curing. Geometrical shape, size and material type also play a major role in the heating characteristics of the object. In order to guarantee a consistent temperature at a set baking time it is necessary to directly measure the object temperature – this is especially true for complex-shaped objects with varying thickness.

The internal temperature distribution of an oven needs to be controlled at regular intervals. Quality assurance according to DIN ISO 9000 also requires professional documentation and increased accuracy. BYK-Gardner's oven temperature recorders fulfill these requirements.

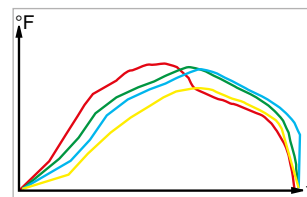
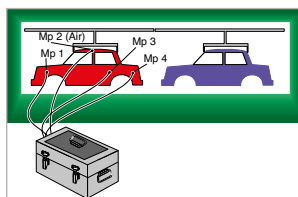

temp-gard

A significant improvement in the recording of oven processes has been made with the temp-gard.

This measurement system stores the analog signals of temperature probes in digital form. A measurement module accompanies the object on its way through the oven without needing a trailing cable. The recording module is protected by a thermal barrier made of stainless steel with absolutely temperature safe insulation.

The digital data is transferred to a computer for further processing. Each measurement is saved as a file.



The temp-gard system controls the curing process and immediately evaluates the results. Within a few minutes all important information is available on the screen and can be printed out:

- The measurement points of the object
- Date and time of the measurement
- Name of the operator and identification of the oven
- Temperatures in °F or °C
- 4-color graphic of the entire measurement curve with display of temperature and time

The peak temperature and a warning message occur when the maximum temperature of a probe is above the control value. It is possible to quickly and regularly check and document the quality of daily production. In addition, this temperature measurement system allows control of oven performance without risking loss of quality.

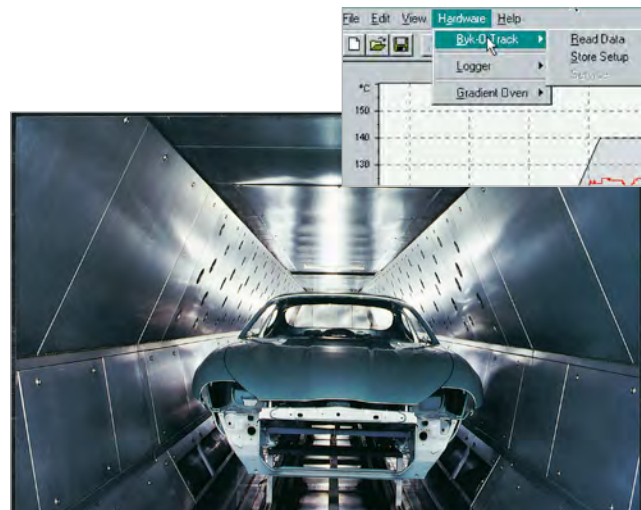

temp-gard collects temperature data in production oven.



temp-gard 12p recorder with thermal barrier

gradient-oven

The gradient-oven is a test apparatus for evaluating the baking and drying behavior of liquid coatings, powder coatings, and resins. The gradient-oven consists of 45 heating elements each micro-processor controlled. Every element has PT-100 temperature probe to precisely record the temperature. A steel test panel is automatically positioned onto the elements. The panel is pressed down for rapid heat transfer.

A linear gradient or step gradient can be programmed to precisely determine the cure temperature. The ramp up temperature rate and bake time can also be programmed to simulate production conditions.

The gradient-oven can be used for accelerated acid-etch tests. By using the temperature gradient and bake time features a precise evaluation can be performed.

- Saves time and energy
- Generates various curing temperatures on one panel
- Simulates the temperature profile of a production oven in the laboratory
- Safety devices that comply with the current standards
- Automatic program control - for precise results

Standards

ISO 2812-5



gradient-oven 2610 with optional printer



Iron oxide temperature stability test on two pigment types



Automotive top-coat chemical etch resistance test panel

Ordering Information

Cat. No.	Description
2602	gradient-oven 250
2610	gradient-oven 300
107302602	Extended Warranty one year additional

Comes complete with:

gradient-oven
 exhaust tube
 1 pc. glass plate
 25 pcs. test panels
 25 pcs. marking strips
 Operating Manual

Technical Specifications

	Temperature	Connection for temp-gard oven recorder
	30 - 250 °C (86 - 482 °F)	included
	30 - 320 °C (86 - 608 °F)	included
Voltage	230 V, 50/60 Hz	
Power Consumption	3400 VA	
Heating Surface	520 x 100 mm (20.4 x 3.9 in)	
Test Surface	500 x 70 mm (19.6 x 2.7 in)	
Heating Elements	45 pcs.	
Pressure Platform	traverses automatically (16 kp) for insertion and removal of panel	
Linear Gradient	max. temp. difference between: 30 and 250 (320) °C: 100 °C; 86 and 482 (608) °F: 180 °F	
Step Gradient	with 2, 3 or 4 steps: max temp. difference between 2 steps: 50 °C (90 °F)	
Heat-Up-Speed	2 °C to 30 °C/min, programmable (3.6 °F/min to 54 °F/min)	
Baking Time	in sec. and min.	
Memory	max. 10 gradients	
Accuracy	control accuracy of the heating elements: < ± 2 °C (+/- 3.6 °F) surface temperatures on 0.8 mm test panels from element 3 to 43: to 200 ° ± 2 °C (to 392 ° ± 3.6 °F) to 250 ° ± 3 °C (to 482 ° ± 5.4 °F) to 320 ° ± 5 °C (to 608 ° ± 9.0 °F) measured under specific test conditions	
Dimensions	465 x 720 x 595 mm (18 x 28 x 23 in)	
Weight	50 kg (110 lbs)	

gradient-oven Accessories

If you have any questions about the accessory items, their availability and pricing, please contact your BYK-Gardner representative.

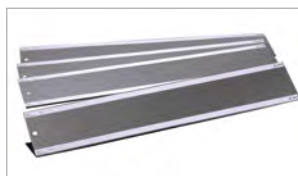

Test Panel with Marking Strip



Application Device



Printer with paper types



Film applicators



Ordering Information

Cat. No.	Description
2636	Self-Adhesive Paper, 2630
2637	Self-Adhesive Strips, 2630
2645	Jig for Powder Coatings
2626	Glass Plate, for 2602, 2610
2623	Test Panels gradient-oven
2628	Film Application Device, 2623
2630	Flat Bed Printer, gradient-oven
2634	Printer Ribbon, 2630
2621	Exhaust Tube
2622	Marking Strip Set, 2623

Accessories

For flat bed printer, Cat. No. 2630; for printing reports; Set of 100 sheets for 200 reports
For flat bed printer, Cat. No. 2630; for printing panel marking strips; Set of 100 sheets for 200 marking strips
To facilitate application of powder
For gradient-oven, Cat. No. 2602 and 2610 to protect heating bank
For application of samples for the gradient-oven; made of ST 14 0 5 steel; dimensions: 568 x 98 x 0.8 mm (22.36 x 3.86 x 0.03 in.); Set of 100
Solid aluminum construction, 6 knurled screws for secure clamping of test panel during paint application, free floating slide jig holds film applicator; Recommended film applicators 2056, 2057
For gradient-oven, Cat. No. 2602 and 2610; incl. accessories
For flat bed printer, Cat. No. 2630
Length 2.5 m (98.4 in.); ø 80 mm (3.1 in.)
Self-adhesive strips for test panels, Cat. No. 2623; Set of 100

Info!

For precise monitoring of your production ovens BYK-Gardner offers the temp-gard oven recorder system.



gradient-oven Applications

The gradient-oven saves time and money in R & D as well as QC testing of raw materials (e.g. additives, pigments, resins, and coatings). It allows you to simulate the conditions of a production oven in the laboratory by downloading temperature profiles recorded with our temp-gard oven recorder. Thus, material properties, baking conditions and production ovens can be optimized for best quality and economical operation.

Temperature stability of iron oxide pigments:

Depending on the chemical composition the various iron oxide pigment types show different temperature stabilities:

	Temperature stability
Red iron oxide:	up to approx. 1200 °C (2192 °F)
Yellow iron oxide:	up to approx. 200 °C (392 °F)
Brown iron oxide:	up to approx. 180 °C (356 °F)
Black iron oxide:	up to approx. 180 °C (356 °F)

In the following example, two yellow iron oxide pigments with different temperature stabilities were tested in a silicone polyester system.

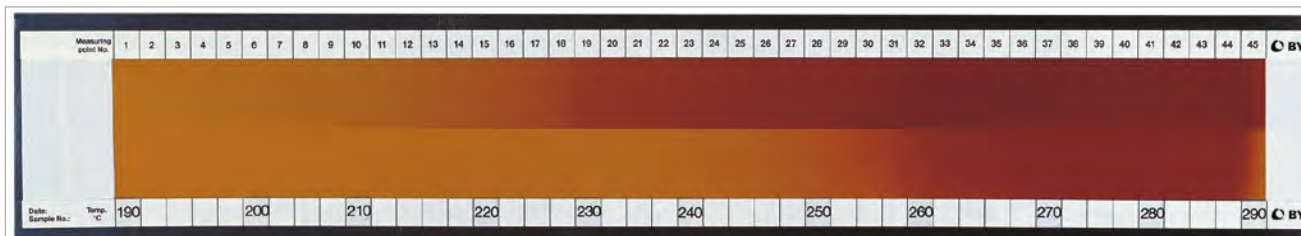

Whenever low temperature stable iron oxide pigments are used in baked coating systems or composite materials, it is very critical to define the production window in which the baking temperature will not affect the mechanical, chemical or the optical specifications.

The high repeatability and reproducibility of the gradient-oven helps to accurately determine the tolerance range. Depending on the gradient-oven type, coatings can be tested with temperatures up to 320 °C. By applying the coating system with a duplex frame applicator two different coating systems can be applied & tested simultaneously on the same panel. This makes the comparison easier, saving application time and material cost.

Results:

Pigment type A starts showing a discoloration at 210 °C, while pigment type B remains color stable up to 250 °C. At temperatures over 280 °C both pigments can no longer be used.

The gradient-oven saves you time and money because the testing is considerably shorter than using a convection oven. In addition, the high precision and tight temperature control of the individual heating elements guarantee you reliable and repeatable results – test after test.

Temperature influence on silicone additives

Inter-coat Adhesion

In a multi-layer system, like automotive coating systems, silicone additives can diminish the inter-coat adhesion. Silicones have the tendency to migrate to the surface. As they don't have reactive groups, they are not integrated in the coating surface of the first layer. Consequently, they would migrate into the surface of the 2nd layer during application. This type of behavior is known as silicone migration.

If the 1st coating layer is baked, reactive groups are created and the silicone additive gets embedded into the resin system of the 1st layer. The capability to migrate is gone which can result in a diminished inter-coat adhesion. The temperature stability of silicones varies depending on how they were modified. The gradient-oven can test the influence of temperature on one panel.

Test procedure:

Two differently modified silicones were tested:

Sample A: BYK®-310 – polyester modified polysiloxane

Sample B: Polyether modified siloxane

The application and baking occurred in two steps. For ease of testing the two layers were differently pigmented – 1st layer white and 2nd layer red. The white coating was applied first and baked in the gradient-oven using the step gradient function: 130 °C – 150 °C – 170 °C – 190 °C for 30 minutes. Then the red pigmented coating was applied and baked under the same conditions.

The quality of the inter-coat adhesion can be evaluated by using a cross-cut tester with tape, or with knife & tape according to a Ford test specification.



BYK®-310 used in sample A

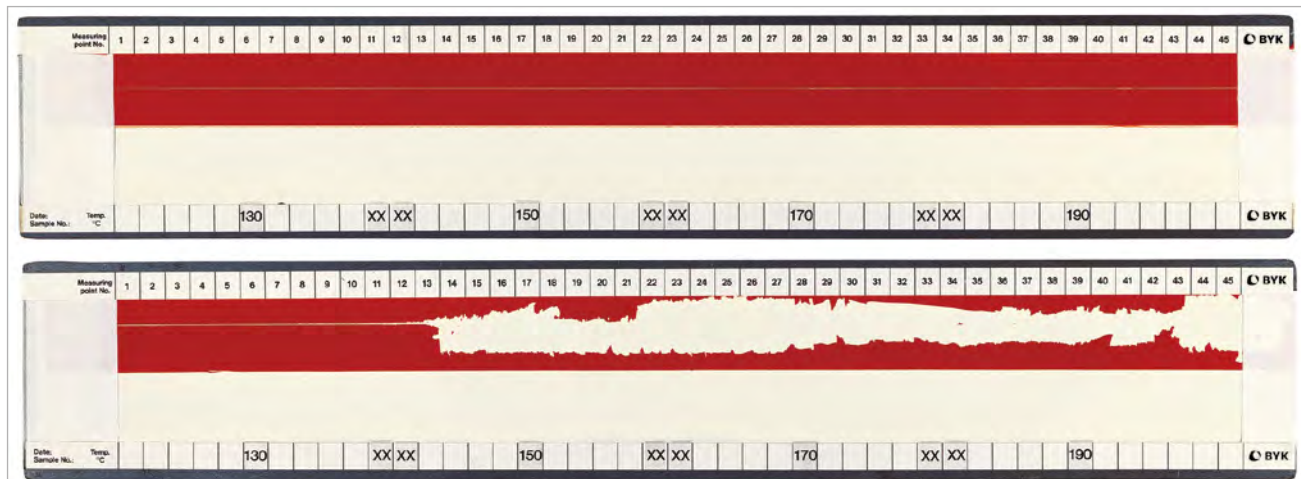

Result according to Ford Test:

Sample A shows excellent inter-coat adhesion at all 4 different temperature ranges. In case of sample B the inter-coat adhesion is destroyed at baking temperatures higher than 150 °C.

Ford Test Specification:

The coating is marked with a knife, adhesive tape is applied to the test surface, pressed on and removed.

Rewetting of 2 coat systems:

At high temperatures silicones can cause wetting problems in a 2 coat application process.

Test procedure:

Two differently modified silicones were tested in an amino-cured alkyd topcoat:

Sample A: BYK®-325

Sample B: Polyether modified polysiloxane

For ease of testing the two layers were differently pigmented – 1st layer white and 2nd layer red. The 2 coats were applied wet on wet with a spray gun and each coat had a wet film thickness of 150 μm . The silicone additives were only added in the 2nd coat.

Both systems were baked in the gradient-oven using the linear gradient function:

120 °C – 190 °C for 30 minutes.

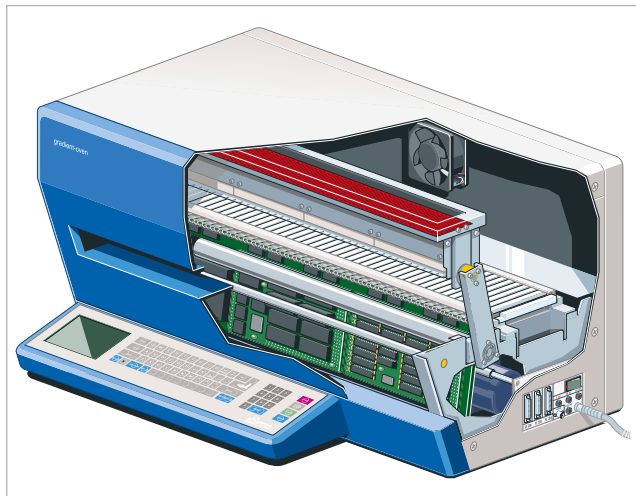

BYK®-325 used in sample A

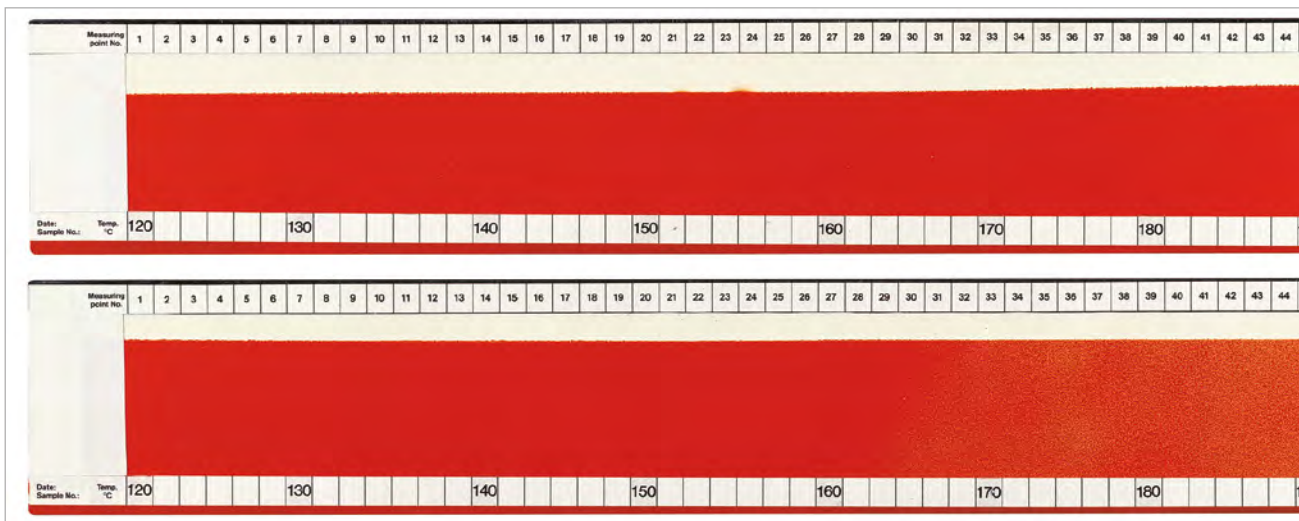

Result:

Sample A was perfectly wetted, while in sample B the two coats "separated" – droplet formation can be seen at higher temperatures. Therefore, sample B can only be exposed to a maximum temperature of 165 °C.

Chemical etch resistance of automotive topcoat systems:

Acid rain, bird droppings, fuel, antifreeze and many other environmental factors can damage automotive finishes. Especially in summertime, some substances can be very aggressive and cause severe damage. Therefore, automotive paint manufacturers as well as auto makers need to find out how different environmental phenomena will interact with a coating system. Throughout the world panels are tested on weathering sites for years to evaluate the influence on color, gloss as well as physical properties.

The gradient-oven has been approved by the automotive industry as an accelerated test method. It allows prediction of how a particular coating system reacts to a specific material at increasing temperature levels. This test method is specified by several automotive companies.



The gradient-oven helps to speed up R & D projects saving time and money. In QC testing of baked coating systems the gradient-oven produces repeatable results many times faster than using traditional convection ovens.

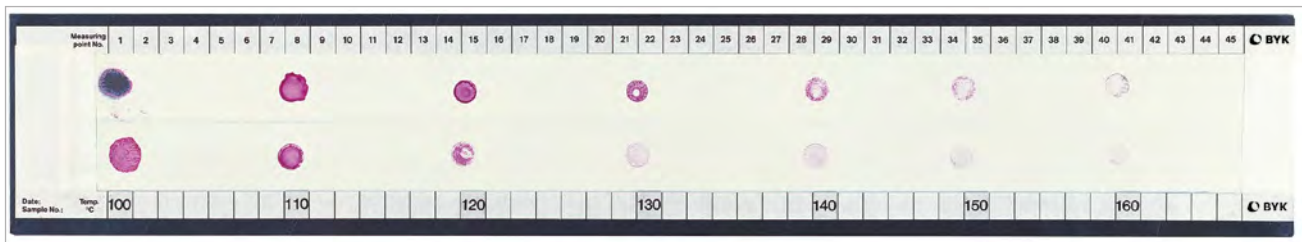

Test procedure:

In a standard test 5 different chemicals can be tested on one panel – e.g. H₂SO₄ which simulates atmosphere and acid rain, NaOH for car wash detergents, pancreatine (bird dropping), brake fluid, and tree resin. The panels are coated and baked under the specified processing conditions. Using a pipette droplets (approx. 0.05 ml) of these various materials are placed about 6 mm apart vertically on the test panel. Repeat this length down the panel with spacing about every 2-3 cm. The gradient-oven is then programmed to have a linear gradient in the range of 35 °C – 80 °C. The panels are now baked at either 20, 30 and / or 60 minutes to allow for evaluation of the coating. After the baking process the panel is washed under running water, dried and visually evaluated. The evaluation should be done after approx. one hour and again after 24 hours to see if any additional etching has occurred.

The temperature is documented at which the first visual changes and damages occurred.

temp-gard *pro*

Oven Temperature Recorder

The temp-gard temperature recorder systems measure and save object and air temperature during the cure process. Documentation and analysis of temperature profiles is made easy with the included temp-chart software.

BYK-Gardner offers a complete line of oven recorders, which allow you to control and optimize your baking process – independent of paint system or measurement points.

Small Logger, Big Display

The large color LCD display allows setting the measurement parameters directly on the logger and the temperature profile of all connected probes is displayed on the screen. Two standard AA Alkaline batteries ensure a long battery life. USB interfaces provide quick and easy data transfer to the PC. The certified high accuracy guarantees long-term reliable results.

Thermal Barrier with Perfect Design

The high-performance thermal barrier is compact and light weight with magnetically attached cooling elements. The thermal characteristics were designed with a temperature buffer to be safe for all common coatings – waterborne, solventborne or powder - up to 2 hours at 250°C. The robust stainless steel housing is easy to clean and its rounded corners provides ergonomic handling.



Temperature Probes for Any Application

- High quality thermocouple type "K" with special limits of error 1.1 °C or 0.4 % (ANSI MC 96.1)
- Magnets or clamps do not influence measurement results
- Connection cable of 1.5 m (59 in), 3 m (118 in) and 8 m (315 in) length available (see table)
- Response time for 100 % measuring range from 5 seconds to 2.5 minutes depending on probe style
- Can be used as replacement probes for other datalogger brands

temp-chart pro

Professional Documentation and Analysis of your Curing Process

temp-chart pro is an easy-to-use software for documentation and analysis of the temperature profile. temp-chart was developed in close cooperation with leading automotive manufacturers.

To analyze the curing data measured with temp-gard, temp-chart will merge the temperature data with oven parameters and analysis criteria to generate a temperature profile. Data will be stored in a database for professional documentation and easy access. The oven process can be optimized with means of the BYK-Gardner Cure Index and Cure Chart.

Organizer Set-up – standardize measurement and sample labeling

Organizers facilitate the setup of measurement parameters and the sample identification, like the number and name of probes, measuring frequency, duration time and starting modes. Product schematics help to define specific sampling procedures. Sensor names can be merged for long term trend comparison. The entered information can be used for filtering or arrangement of the measured data saved in the database. Typical identifiers are name, date and title.

Speed up your QC with defined procedures

Complete your curing process analysis with a click. Predefined QC procedures can be assigned to an organizer for automatic data analysis after data transfer.

- Curing conditions – duration time at specific temperature levels
- Oven specifications – speed, zone numbers, oven length
- Tolerance curves or Pass/Fail conditions with traffic light indication or highlighted fail values for analysis at a glance.

Additionally, the Cure Chart analysis quickly determines the efficiency of the curing process and which temperature sensors have met the cure conditions.

Data analysis – Detailed measurement reports

Depending on your needs, temp-chart offers a variety of measurement reports. The user can define the protocol content:

Graphic with temperature profile and upper/lower limits

- Cure Chart analysis
- Data table with Pass/Fail info based on user defined parameters
- Product schematics and process information

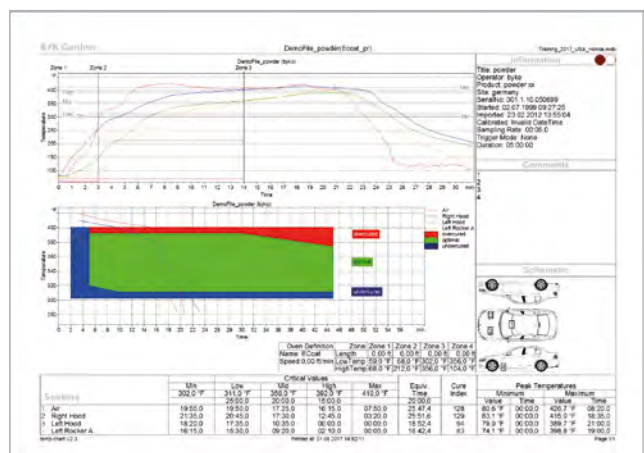
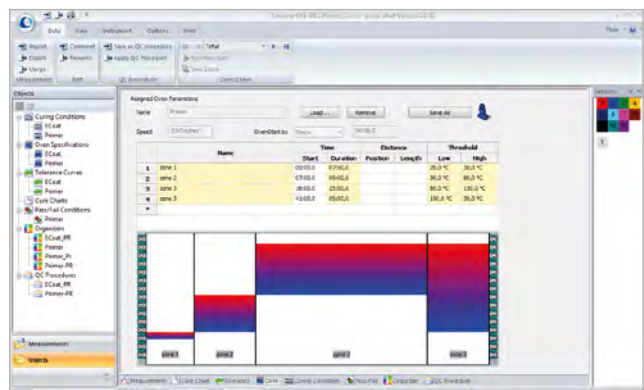
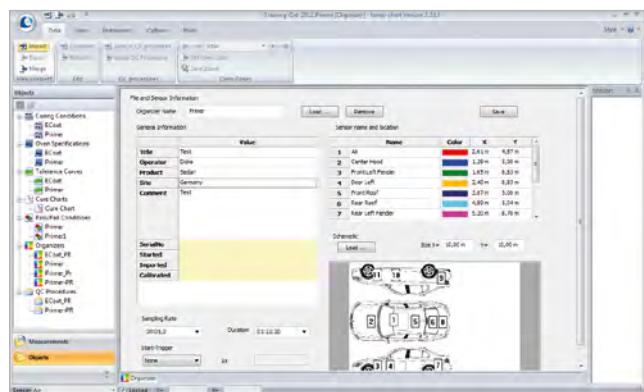

Save!

temp-gard dual consists of 2 x temp-gard pro 12p systems for controlling up to 24 measurement locations – at a special package price.



Ordering Information

Cat. No.	Description
3329	temp-gard dual
3319	temp-gard pro 12p
3309	temp-gard pro 12p C
3308	temp-gard pro 12p, no probes
3317	temp-gard pro 6p
3307	temp-gard pro 6p C
3306	temp-gard pro 6p, no probes

System Requirements:

Operating system: Windows® 7 or higher
 Memory: min. 1 GB
 Hard disk capacity: min. 100 MB
 Monitor resolution: XGA (1024 x 768) or higher
 Interface: USB-port

Note: temp-chart licence fee for more than two installations is quantity dependent. Please contact your local BYK-Gardner representative.

Probes	
	24 magnetic probes = 2 air probes, 22 object probes
	12 magnetic probes = one air probe, 11 object probes
	12 clamp probes = one air probe, 11 object probes
	12 probe connections at logger; No probes*
	6 magnetic probes = one air probe, 5 object probes
	6 clamp probes = one air probe, 5 object probes
	6 probe connections at logger; No probes*
Accuracy	± 0.5 °C
Resolution	0.1 °C (0.18 °F) from 0 - 400°C (32 - 752 °F)
No. of Channels	6 or 12
Memory	240,000 readings
Sampling Interval	0.1 sec up to 5 min
Temperature Range	0 - 400 °C (32 - 752 °F)
Battery Capacity	0.5 sec interval = 25 hrs (AA Alkaline)
Display	Color, 79 x 60 mm (3.1 x 2.4 in)
Interface	USB 2.0
Thermal Barrier	255 x 215 x 135 mm
Dimensions	(10.0 x 8.5 x 5.3 in)
Weight	3.56 kg (7.82 lbs)
Maximum Duration	at 100 °C, 8.5 hrs; at 200 °C, 2.5 hrs; at 250 °C, 2.0 hrs

* Probes must be ordered separately for temp-gard 3306 & 3308.

temp-gard *basic*

The temp-gard basic temperature recorder system consists of a small logger with a large, easy-to-read color display, a robust yet light weight thermal barrier and temp-chart basic software for fast and easy Pass/Fail data analysis. The ideal solution for industrial coating applications: all you need to control and optimize your baking process.

Compact Thermal Barrier

The thermal barrier is robust, yet compact and easy to carry. The thermal characteristics are designed with a temperature buffer to be safe for all common coatings – waterborne, solventborne or powder - up to 2 hours at 250°C. The robust anodized aluminum housing is chemical resistant and its cooling elements are handy.

temp-chart basic – Easy Data Analysis

temp-chart basic offers all essential parameters for analysis and optimization of your curing process. The use of Organizers standardizes the measurement analysis. Based on the curing conditions of your coating system the Pass/Fail analysis will show when the Cure Index or other critical values were exceeded. Measurement reports are user definable.

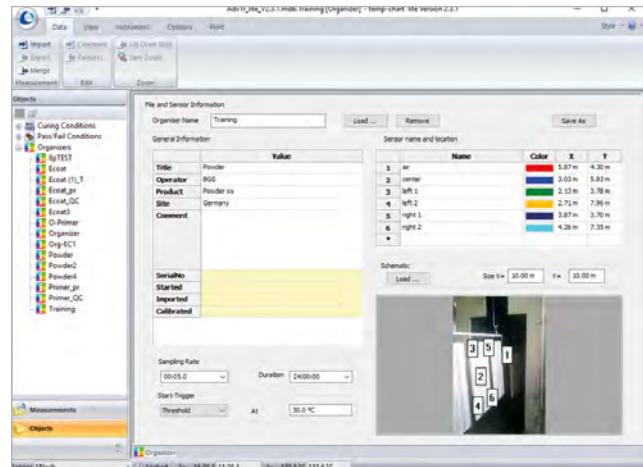

Ordering Information

Cat. No.	Description
3341	temp-gard basic
3345	temp-gard basic C
3346	temp-gard basic, no probes

Comes complete with:
temp-gard 6p data logger
6 probes
Thermal barrier *basic*
Set of heat sinks *basic*
temp-chart *basic* software
Interface cable to PC
2 AA Alkaline batteries
Operating manual
Certificate
Carrying case
1/2 day training

System Requirements:

Operating system: Windows® 7 or higher
Memory: min. 1 GB RAM
Hard-disk capacity: min. 100 MB
Monitor resolution: XGA (1024 x 768) or higher
Interface: USB port

Probes

6 magnetic probes = one air probe, 5 object probes

6 clamp probes = one air probe, 5 object probes

6 probe connections at logger; No probes*

Accuracy	± 0.5 °C
Resolution	0.1 °C (0.18 °F) from 0 - 400°C (32 - 752 °F)
No. of Channels	6
Memory	240,000 readings
Sampling Interval	0.1 sec up to 5 min
Temperature Range	0 - 400 °C (32 - 752 °F)
Battery Capacity	0.5 sec interval = 25 hrs (AA Alkaline)
Display	Color, 79 x 60 mm (3.1 x 2.4 in)
Interface	USB 2.0
Thermal Barrier	270 x 215 x 140 mm
Dimensions	(10.6 x 8.5 x 5.5 in)
Weight	4.3 kg (9.5 lbs)
Maximum Duration	at 100 °C, 8.5 hrs at 200 °C, 2.5 hrs at 250 °C, 2.0 hrs

* Probes must be ordered separately for temp-gard 3346.

Note: temp-chart licence fee for more than two installations is quantity dependent. Please contact your local BYK-Gardner representative.

temp-gard Accessories

Temperature Probes



Style C Style A



Style B style D

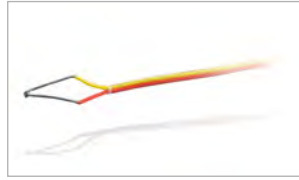

Style F (0.3 mm)



Style J

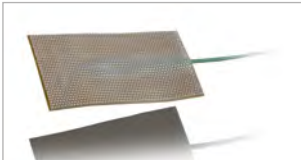

Style E

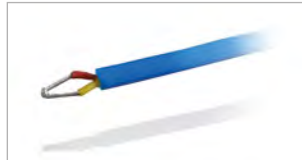

Style F



Style H



Style I



Ordering Information

Cat. No.	Description
3121	Object Probe A, 1.5m
3122	Object Probe A, 3m
3123	Object Probe A, 8m
3124	Object Probe B, 1.5m
3125	Object Probe B, 3m
3126	Object Probe B, 8m
3127	Air Probe C, 1.5m
3128	Air Probe C, 3m
3129	Air Probe C, 8m
3130	Air Probe D, 1.5m
3131	Air Probe D, 3m
3132	Air Probe D, 8m
3133	Foil Probe
3134	Open Probe F, 1.5m
3135	Open Probe F, 3m
3136	Open Probe F, 8m
3147	Special Open Probe (0.3mm)
3146	Object Probe G
3149	Washer Probe J
3143	IR Probe H
3144	IR Probe I
3137	Extension 3m
3138	Extension 5m

Accessories

Style	Probe	Length	Attachment	Max Temperature
A	object	1.5 m	clamp	509 °F (265 °C)
A	object	3 m	clamp	509 °F (265 °C)
A	object	8 m	clamp	509 °F (265 °C)
B	object	1.5 m	magnet	509 °F (265 °C)
B	object	3 m	magnet	509 °F (265 °C)
B	object	8 m	magnet	509 °F (265 °C)
C	air	1.5 m	clamp	509 °F (265 °C)
C	air	3 m	clamp	509 °F (265 °C)
C	air	8 m	clamp	509 °F (265 °C)
D	air	1.5 m	magnet	509 °F (265 °C)
D	air	3 m	magnet	509 °F (265 °C)
D	air	8 m	magnet	509 °F (265 °C)
E	foil	1.5 m		509 °F (265 °C)
F	open junction	1.5 m		509 °F (265 °C)
F	open junction	3 m		509 °F (265 °C)
F	open junction	8 m		509 °F (265 °C)
F	open junction	3 m		509 °F (265 °C)
G	object	1.5 m	eyelet 4.5 mm ø	932 °F (500 °C)
J	object	3 m	eyelet 6 mm ø	509 °F (265 °C)
H	IR	3 m	magnet	509 °F (265 °C)
I	IR	3 m	clamp	509 °F (265 °C)
	extension	3 m		509 °F (265 °C)
	extension	5 m		509 °F (265 °C)



Ordering Information

Cat. No.	Description
3311	temp-chart pro
3344	temp-chart basic
3325	Thermal Barrier pro
3342	Thermal Barrier basic
3326	Heat Sink pro
3343	Heat Sink basic
3320	temp-gard logger 12p
3318	temp-gard logger 6p
6337	USB Interface Cable
3038	Adhesive Tape for foil probe

Accessories

Additional information
analysis: Cure Index, Cure Chart, graph, critical values, tolerance, QC procedure
analysis: Cure Index, graph, critical values
incl. 2 heat sinks, max duration at 250 °C, 2h
incl. 2 heat sinks, max duration at 250 °C, 2h
1 piece
1 piece
logger with 12 probe connections
logger with 6 probe connections
to connect the logger to the PC, USB-A plug, 3 m length
heat-proof adhesive tape for attachment of foil probes

PosiTector DPM

Dew Point Meter

This new meter helps bring a new level of confidence to the painting contractor and inspector. Measure and record climatic parameters including air temperature and relative humidity to calculate dew point temperature. The difference between surface and dew point temperatures is critical for determining condensation probability. This meter is ideal for surface preparation, as required by ISO 8502-4.

- Rugged indoor/outdoor instrument is solvent, acid, oil, water and dust resistant – take it anywhere
- Sliding cover on the sensor protects it when not in use and the white housing reduces the effect of direct sunlight for greater precision
- The meter has a soft rubber holster for easy handling and can be removed to accurately spot check hard-to-reach areas
- Fast response precision sensors provide accurate, repeatable readings with high reliability and long term stability
- Indicators to identify changing environmental conditions
- Universal gage body to accept film thickness sensors and surface roughness sensor
- USB port for fast and simple PC downloads

The PosiTector DPM comes in two models:

Standard Model

- Monochrome Display
- Storage of 2500 datasets
- Auto Log Mode automatically records all 5 parameters at user selectable time intervals



Standards

ASTM	D 3276
ISO	8502-4
BS	7079-B4

Advanced Model

- Hi Contrast rotatable color LCD display
- Storage of 20,000 datasets and 1000 batches and sub-batches
- WiFi technology for connectivity to mobile devices
- Auto Log Mode automatically records all 5 parameters with data streaming via USB or WiFi
- On screen help, real time graphing, picture prompting, and batch notes
- Data transfer via USB or Bluetooth™ to a PC or printer

Technical Specifications

Surface Temperature	-40 to 190 °C (-40 to 375 °F)
Accuracy	± 0.5 °C (1 °F) from -40 to 80 °C (-40 to 175 °F); ± 1.5 °C (3 °F) from 80 to 190 °C (175 to 375 °F)
Air Temperature	-40 to 80 °C (-40 to 175 °F)
Accuracy	± 0.5 °C (± 1 °F)
Humidity	0 - 100 %
Accuracy	± 3%
Resolution	0.1 °C (0.1 °F) for temperature; 0.1 % for humidity
Dimensions	159 x 61 x 31 mm (6.25 x 2.4 x 1.2 in)
Weight	150 g (0.33 lbs)

Accessories

Battery power or AC Power Kit, Protective Lens Shield



Ordering Information

Cat. No.	Description
1170	PosiTector DPM Standard
1172	PosiTector DPM Advanced

Comes complete with:

Humidity, air and surface temperature sensors
 3 AAA batteries
 Rubber holster with belt clamp and wrist strap
 Nylon carrying case with shoulder strap
 Built-in infrared port for printing to a wireless IR printer
 NIST traceable certificate
 Operating instructions
 2 year warranty



Ordering Information

Cat. No.	Description
1175	Bluetooth™ Printer, for DPM Advanced only

Introduction

Viscosity is a measure of the resistance of a fluid to deform under shear stress. It is commonly perceived as flow behaviour or resistance to pouring. Viscosity describes a fluid's internal resistance to flow and may be thought of as a measure of fluid friction.

Viscosity plays a key role in the processing stage!

For certain liquids, viscosity is a material constant that only depends on temperature and pressure. This group of materials is termed Newtonian liquids.

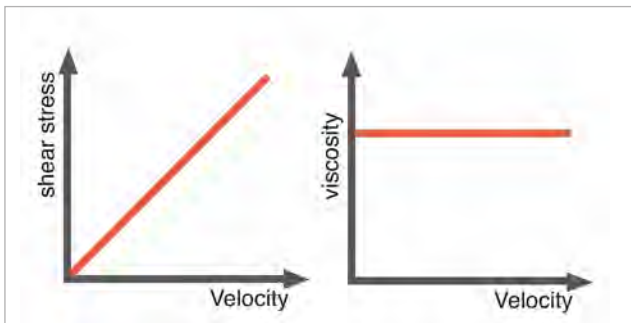

Newtonian

Liquids which do not follow this proportional ratio are called non-Newtonian.

In practice, time-dependent viscosity is called thixotropy. If a liquid is sheared at a constant velocity gradient, viscosity will slowly decrease. As soon as the shear forces are removed, viscosity will recover and return to the initial value.

Thixotropy

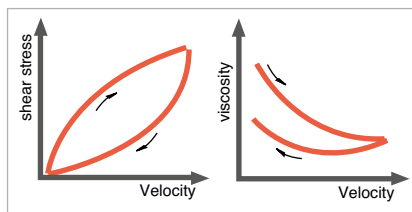

The viscosity of pseudoplastic materials will decrease with an increasing shear rate (shear thinning).

Pseudoplastic
(Shear-Thinning)

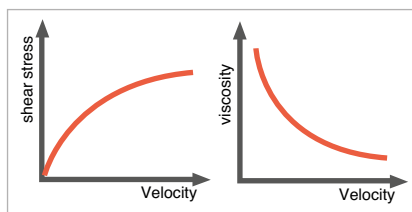

VISCOSITY

The viscosity of dilatant products, however, will increase when shear forces are applied.

Dilatant
(Shear-Thickening)

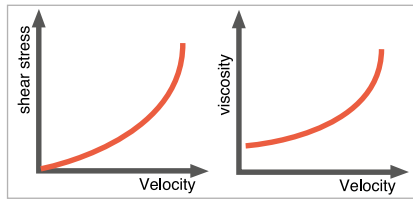

This behavior is known as “shear thickening”. When shear forces are applied, the liquid becomes more viscous.

Viscosity Measurement

In the paint industry a number of measurement methods, from simple flow cup to computer controlled rotational viscometers, have been established for the determination of viscosity. BYK-Gardner offers a complete line of viscosity measurement instrumentation.

Bubble Viscometers

The Alphabetical Comparison Method uses 4 sets of lettered reference tubes, A5 through Z10, of known viscosity to cover a viscosity range from 0.005 to 1,000 stokes.

The Direct Time Method uses a single 3-line timer tube for determining the “bubble seconds” required for an air bubble to travel a known vertical distance through a bore of known diameter. These “bubble seconds” may then be converted to stokes.



Both methods are subject to variations traceable to the following variables:

Temperature:	$\pm 1^{\circ} \text{C}$	= 10% error
Vertical Control	$\pm 5^{\circ} \text{C}$ slant	= 10% error
Tube I.D. Control	$\pm 0.1 \text{ mm}$	= 2% error

Dip Cups

These cups are designed for quick and approximate determination of efflux times for paints and similar fluids at paint manufacturers and paint user sites.



Dip Cups



Flow Cups

Flow Cups

For many applications it is not necessary to know the absolute viscosity of a paint system. A parameter permitting a relative classification and estimation is often sufficient. The efflux time, measured in seconds, has proven to be a practical measure. It is determined using flow cups of various designs following the appropriate international / national standards. These cups hold a defined volume of liquid which flows through an orifice. The reproducibility of such measurements depends on

- The accuracy of the size of the cup
- A constant temperature during measurement
- The Newtonian flow behaviour of the liquid

Rotational Viscometers

Various rotational viscometers are in use for the determination of the viscosity of non-Newtonian liquids. These types of material exhibit different viscosities depending on the applied shear rate. BYK-Gardner offers a complete line of viscometers for any application: Stormer Viscometer, Cone and Plate Viscometer as well as Brookfield Viscometers with different cylinders, tubes and other measuring accessories.



Bubble Viscometers

BYK-Gardner bubble viscometers are used to quickly determine kinematic viscosity of known liquids such as resins and varnishes. The bubble viscometer tubes are also described as Gardner-Holdt tubes.

- The liquid standards are sealed in glass tubes
- Shelf life is 15 years
- Sample tubes can be cleaned quickly and easily
- Tubes have no orifices that can be clogged to cause faulty measurements
- Repeated readings may be taken easily once the temperature has been controlled

The time required for an air bubble to rise is directly proportional to the viscosity of the liquid – the faster the bubble rises, the lower the viscosity. BYK-Gardner bubble viscometers come in lettered tubes A5 through Z10 in four different tube sets covering viscosity ranges from 0.05 to 1,000 stokes.

Certified

Our bubble tubes can be recertified to NIST traceable standards.



Bubble Viscometer A-T

Standards

AOC	Method Ka 6-63
ASTM	D 1131, D 1545, D 1725
FTMS	141a Method 4272

Ordering Information

Cat. No.	Description
0500	Bubble Viscometer A5-A1
0600	Cert. Bubble Viscometer A5-A1
0510	Bubble Viscometer A-T
0610	Cert. Bubble Viscometer A-T
0540	Bubble Viscometer U-Z6
0640	Cert. Bubble Viscometer U-Z6
0560	Bubble Viscometer Z7-Z10
0660	Cert. Bubble Viscometer Z7-Z10

Comes complete with:

Bubble Viscometers:
Bubble tube standards
Storage case
Two empty tubes
Operating manual
Certified Sets come with certificate

Technical Specifications

Stokes	
0.05 - 0.31	Set of 5 bubble tube standards A5 - A1 with 2 empty tubes (Grade A)
0.5 - 5.5	Set of 20 bubble tube standards A - T with 2 empty tubes (Grade A)
6.66 - 151	Set of 12 bubble tube standards U - Z6 with 2 empty tubes (Grade A)
406 - 1190	Set of 4 bubble tube standards Z7 - Z10 with 2 empty tubes (Grade A)

Note: Individual replacement tubes can be ordered separately.

Bubble Viscometer Procedure

- Knowing the approximate viscosity, pick four standard tubes closest in viscosity to your sample
- Fill the sample tube with liquid, insert a cork, and then using the tube holder 0577, insert the four lettered tubes and the sample tube into the holder
- Turn over the holder and visually compare what letter best matches the rise time of the bubble in the sample
- The rise time in seconds of the sealed tubes and samples can also be determined using a basic timer

Please be aware of the following accuracies when performing the test:

Temperature control: 1 °C = 10 % error

Verticality control: 5° slant = 10 % error

Tube I.D. control: 0.1 mm = 2 % error



Ordering Information

Cat. No.	Description
0571	Empty Tubes Grade A
0573	Empty Tubes Grade B
0575	Empty Tubes Grade N
0576	Corks
0577	Holder for 5 Tubes

Comes complete with:

Empty tubes in lots of 144 per package including corks

ASTM D 1545 Timer Method

The tube has three amber ring marks at 27, 100 and 108 mm from the bottom. Fill the tube up to the 100 mm line, insert the cork down to the 108 mm line and turn the tube bottom up. Turn the tube around, start the stop watch when the air bubble crosses the 27 mm line and stop when the bubble crosses the 100 mm line.

Accessories

Inscription GARDNER MT in amber stain; inside diameter is checked for 10.65 ± 0.025 mm

Inscription GARDNER BT in amber stain; economical tube for making routine laboratory or factory comparisons; inside diameter 10.75 mm

Inscription GARDNER in amber stain; inside diameter is checked for 10.65 ± 0.025 mm; one additional marking at the bottom of the tube for establishing 73 mm bubble path; ASTM D 1545 term: Timer Tubes

For use in retaining samples; used with all grades of tubes; supplied in lots of 150 per bag

Standards and samples are placed parallel to each other in a true vertical position; sturdy metal frame with plastic handle; fits up to 5 tubes; the flat area allows the holder to sit in a water bath or on a lab bench; comes without tubes

Note: Amber markings in permanent stain are located on the empty tubes for establishing correct bubble size.

Bubble Viscometers

Standards

AOC	Method Ka 6-63
ASTM	D 1131, D 1545, D 1725
FTMS	141a Method 4272



Ordering Information

Cat. No.	Description	Cat. No.	Description
0501	Tube A5	0601	Cert. Tube A5
0502	Tube A4	0602	Cert. Tube A4
0503	Tube A3	0603	Cert. Tube A3
0504	Tube A2	0604	Cert. Tube A2
0505	Tube A1	0605	Cert. Tube A1
0511	Tube A	0611	Cert. Tube A
0512	Tube B	0612	Cert. Tube B
0513	Tube C	0613	Cert. Tube C
0514	Tube D	0614	Cert. Tube D
0515	Tube E	0615	Cert. Tube E
0516	Tube F	0616	Cert. Tube F
0517	Tube G	0617	Cert. Tube G
0518	Tube H	0618	Cert. Tube H
0519	Tube I	0619	Cert. Tube I
0520	Tube J	0620	Cert. Tube J
0521	Tube K	0621	Cert. Tube K
0522	Tube L	0622	Cert. Tube L
0523	Tube M	0623	Cert. Tube M
0524	Tube N	0624	Cert. Tube N
0525	Tube O	0625	Cert. Tube O
0526	Tube P	0626	Cert. Tube P
0527	Tube Q	0627	Cert. Tube Q
0528	Tube R	0628	Cert. Tube R
0529	Tube S	0629	Cert. Tube S
0530	Tube T	0630	Cert. Tube T
0541	Tube U	0641	Cert. Tube U
0542	Tube V	0642	Cert. Tube V
0543	Tube W	0643	Cert. Tube W
0544	Tube X	0644	Cert. Tube X
0545	Tube Y	0645	Cert. Tube Y
0546	Tube Z	0646	Cert. Tube Z
0547	Tube Z1	0647	Cert. Tube Z1
0548	Tube Z2	0648	Cert. Tube Z2
0549	Tube Z3	0649	Cert. Tube Z3
0550	Tube Z4	0650	Cert. Tube Z4
0551	Tube Z5	0651	Cert. Tube Z5
0552	Tube Z6	0652	Cert. Tube Z6
0561	Tube Z7	0661	Cert. Tube Z7
0562	Tube Z8	0662	Cert. Tube Z8
0563	Tube Z9	0663	Cert. Tube Z9
0564	Tube Z10	0664	Cert. Tube Z10

Technical Specifications

Approx cSt	Approx Sec
5.1	0.650
7.1	0.663
14.0	0.720
21.3	0.767
31.0	0.820
53.6	0.936
68.8	1.01
92.7	1.21
102.9	1.30
122.7	1.50
151.9	1.67
160.0	1.85
210.8	2.15
224.2	2.32
268.2	2.75
287.9	3.02
302.3	3.19
335.4	3.45
345.2	3.69
377.9	3.98
408.8	4.24
441.8	4.54
467.4	4.85
517.7	5.29
547.2	6.00
665.9	6.79
889.2	8.97
1073	11.5
1200	14.8
1737	18.4
2289	23.7
2909	30.7
4056	40.2
4840	48.0
7241	72.2
9917	105
15080	158
40650	422
73280	764
91500	955
119000	1240

Note: Centistokes and Seconds values are based on 25°C (77°F).

Viscosity Cups

A flow cup, sometimes called an efflux cup or viscosity cup, is a simple gravity device that measures the timed flow of a known volume of liquid passing through an orifice located at the bottom of the shaped cup. Under ideal conditions, this rate of flow would be proportional to the kinematic viscosity (expressed in stokes and centistokes) that is dependent upon the specific gravity of the liquid. For many applications it is not necessary to know the absolute viscosity. The efflux time, measured in seconds, is often sufficient for a relative classification.

At least 50 types of flow cups have been developed and used over the years, mainly for production control and field inspection purposes. Most of these simple cups are of two main types – mounted on a stand for filling and draining, or dipped directly into the liquid container before draining back into the same container. No matter which type of cup is used there are several fundamental principles that should be recognized:

- Precautions should be taken whenever thixotropic or other non-Newtonian liquids are tested for viscosity, because there is no definite rate of shear generated in a flow cup.
- The diameter of the orifice should be selected and maintained so as to provide flow times falling within prescribed minimum and maximum limits.
- The temperature of the draining liquid should be controlled and measured only in the efflux stream, after it passes through the undamaged bore.

Procedure

- Place flow cup in a precisely horizontal position using ring stand or temperature control jacket
- Close orifice
- Pour in test liquid
- Draw a clean glass plate over the rim of the cup, removing superfluous liquid into the overflow reservoir and closing the cup
- Remove glass plate horizontally
- Open the orifice and start the stopwatch simultaneously
- Stop the watch with the first break in the efflux stream
- Repeat the measurement three times, each with a new sample of the same material

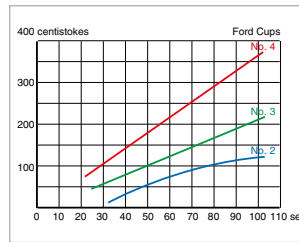

Ford Cup Calibration Curves

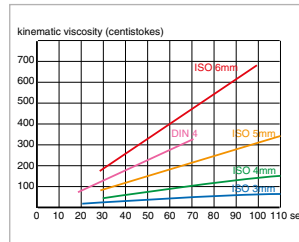

DIN and ISO Cups Calibration Curves



Tripod Stand with Efflux cups



DIN/ISO Dip Cups

Viscosity Cups

BYK-Gardner DIN Dip Cups are designed for quick, approximate determination of efflux times for paints and similar liquids in workshops, at paint manufacturers' and customers'.

- Simple and durable
- Inner dimensions in accordance with DIN 53211* / ISO 2431
- Protected loop handle
- Orifice of stainless steel

The different models meet the requirements for standardized flow cups. A special loop handle of stainless steel mounted on the side facilitates the handling of the dip cup (protected version "GM NO. 7146399")

Procedure

- Immerse dip cup with upper rim below the surface of the liquid
- Simultaneously with vertical withdrawal of cup, start stop-watch
- Stop when stream of liquid under the orifice breaks
- For evaluation purposes carry out three measurements
- The average value of these three measurements is taken as the efflux time



Ordering Information

Cat. No.	Description
0304	DIN Dip Cup 4mm, Alu
0334	ISO Dip Cup 4mm, Alu
0335	ISO Dip Cup 5mm, Alu
0314	DIN Dip Cup 4mm, Polyamide

*Note: DIN 53211 was withdrawn in October 1996

Technical Specifications

Material of Cup	Material of Orifice	Diameter of Orifice	Inner Dimension in acc. with
Aluminum	Stainless Steel	4 mm	DIN 53211* / ISO 2431
Aluminum	Stainless Steel	4 mm	DIN EN ISO 2431
Aluminum	Stainless Steel	5 mm	DIN EN ISO 2431
Polyamide	Brass	4 mm	DIN 53211* / ISO 2431

Zahn-Type Dip Cups

Viscosity Cups

BYK-Gardner Dip Viscosity Cups (Zahn Type) may be used anywhere – in shops, factories and laboratories – for quickly checking and adjusting the viscosity of many different types of liquids.

- Simple and durable
- Range from about 20 to 1800 centistokes
- Precision-drilled orifices
- Orifice diameters adjusted at the factory for appropriate results with applicable NIST traceable Newtonian oils

Each cup has a 12-inch loop handle to allow the cup to be dipped by hand into a liquid container. At the center of this handle is a finger-ring for holding the cup in a vertical position during use. Results should be reported in Zahn-Seconds at a specified temperature for a particular cup. To convert Zahn-Seconds to centistokes, refer to ASTM D 4212.

$$\text{Centistokes} \times \text{Specific Gravity} = \text{Centipoise}$$

$$\text{Centistokes} = K * (\text{efflux time} - C)$$



	Conversion Factors	K	C
Cup# 1		1.1	29
Cup# 2		3.5	14
Cup# 3		11.7	7.5
Cup# 4		14.8	5
Cup# 5		23	0

Standards

ASTM D 816, D 1084, D 4212



Ordering Information

Cat. No.	Description	Cat. No.	Range	Seconds
		with Certificate	in Centistokes	Range
8201	Zahn Type Cup No.1	8206	60 Max.	20 - 84
8202	Zahn Type Cup No.2	8207	30 - 230	22 - 80
8203	Zahn Type Cup No.3	8208	150 - 830	20 - 80
8204	Zahn Type Cup No.4	8209	230 - 1100	20 - 80
8205	Zahn Type Cup No.5	8210	460 - 1800	20 - 78

Net Weight 0.2 kg (0.4 lbs)

Shipping Weight 0.4 kg (1 lbs)

Zahn-Type Dip Cups

BYK-Gardner offers the EZ™ and Signature™ brand zahn cups. These cups are also widely used for many industrial applications.

S90 Signature Cups



Ordering Information

Cat. No.	Description	Cat. No. with Certificate	Range in Centistokes	Seconds Range
6919	S90 Zahn Cup No.1	8300	15 - 78	31 - 60
2102	S90 Zahn Cup No.2	8301	39 - 238	19 - 60
2103	S90 Zahn Cup No.3	8302	63 - 604	11 - 60
2104	S90 Zahn Cup No.4	8303	97 - 899	10 - 60
6920	S90 Zahn Cup No.5	8304	219 - 1627	10 - 60

Note: Efflux time from the S90 cups does not meet ASTM D4212

$$\text{Centistokes} = K * \text{efflux time} - (C / \text{efflux time})$$

	Conversion Factors	K	C
Cup# 1		1.59	1070
Cup# 2		4.18	760
Cup# 3		10.23	575
Cup# 4		15.13	545
Cup# 5		27.27	540

EZ Series Zahn Cups

■ In compliance with ASTM D 4212



Ordering Information

Cat. No.	Description	Cat. No. with Certificate	Range in Centistokes	Seconds Range
2106	EZ Zahn Cup No.1	8305	10 - 36	40 - 60
2107	EZ Zahn Cup No.2	8306	19 - 156	20 - 60
2108	EZ Zahn Cup No.3	8307	64 - 596	12 - 60
2109	EZ Zahn Cup No.4	8308	79 - 784	10 - 60
6922	EZ Zahn Cup No.5	8309	161 - 1401	10 - 60

$$\text{Centistokes} = K * \text{efflux time} - (C / \text{efflux time})$$

	Conversion Factors	K	C
Cup# 1		0.875	993
Cup# 2		2.8	747
Cup# 3		10.09	587
Cup# 4		13.26	673
Cup# 5		23.56	744

Flow Cups

Ford Viscosity Cups

BYK-Gardner Ford Viscosity Cups are guaranteed to be within 3% (drain time of calibration oil) throughout the recommended use range.

- For low viscosity liquids
- Body made of solid bar aluminum
- Stainless steel orifice
- Calibrated against standard oils referenced to certified NIST oils (National Institute of Standards and Technology of United States)
- Certified cups available on request

	K	C
Ford Cup No. 2	1.24	770
Ford Cup No. 3	2.31	550
Ford Cup No. 4	3.7	400

Standards

ASTM	D 333, D 365, D 1200
-------------	-------------------------



Ford Cup No. 4

DIN Flow Cup

This cup holds 100 ml ± 1 ml, and has an integrated orifice with a diameter of 4 mm ± 0.02 mm.

- For low viscosity liquids
- Body made of anodized aluminum
- Stainless steel orifice, interior polished
- Calibrated against standard oils referenced to certified PTB oils (Federal Institute of Physics and Metrology of Germany) to be within 3% (drain time of calibration oil)

	K	C
DIN 4 mm	4.57	452

Standards

DIN	53 211*
------------	---------



DIN Cup 4 Certificate included

ISO Flow Cup

This cup has a longer orifice, less tapered body and slightly different inner dimensions than the DIN 53211* flow cup and thus provides different efflux times. The extended measurement range makes the ISO cup a useful supplement of the DIN cup.

- Recommended for international use
- Body made of anodized aluminum
- Stainless steel orifice, interior polished
- Calibrated against standard oils referenced to certified PTB oils to be within 3% (drain time of calibration oil)

	K	C
ISO 3 mm	0.443	200
ISO 4 mm	1.37	200
ISO 5 mm	3.28	220
ISO 6 mm	6.9	570

Standards

ASTM	D 5125
ISO	2431



Flow Cup ISO 3 mm
Certificate included

Centistokes = K * efflux time - (C/ efflux time)

Centipose = Centistokes x Specific Gravity

Flow Cups

These flow cups offer a more precise viscosity measurement compared to a dip cup. A stand is used to hold the flow cup level and allows the operator to control the start measurement time. Jacketed stands or waterbath stands are available to control the sample temperature prior to and during the measurement.

The flow cups have a sturdy design to prevent damage during handling and cleaning.



Appearance

Color

Viscosity

Technical Service

Index



Ordering Information

Cat. No.	Description
7201	Ford Viscosity Cup No. 2
0172	Ford Viscosity Cup No. 2
0175	Ford Viscosity Cup No. 3
0173	Ford Viscosity Cup No. 3
0176	Ford Viscosity Cup No. 4
0174	Ford Viscosity Cup No. 4
0140	DIN Flow Cup 2 - 8 mm**
0115	DIN Flow Cup, 4 mm
0213	ISO Flow Cup 3 mm
0214	ISO Flow Cup 4 mm
0215	ISO Flow Cup 5 mm
0216	ISO Flow Cup 6 mm

Technical Specifications

Standard	Certificate	Range in Centistokes	Efflux Time	Orifice Diameter
ASTM	No	25 - 120	30 - 100	0.10 in
ASTM	Yes	25 - 120	30 - 100	0.10 in
ASTM	No	40 - 220	25 - 105	0.13 in
ASTM	Yes	40 - 220	25 - 105	0.13 in
ASTM	No	70 - 370	20 - 105	0.16 in
ASTM	Yes	70 - 370	20 - 105	0.16 in
DIN 53211*	No	see 0152 to 0158		interchangeable orifices
DIN 53211*	Yes	100 - 500	20 - 110	4 mm
ISO 2431	Yes	10 - 40	30 - 100	3 mm
ISO 2431	Yes	25 - 130	25 - 100	4 mm
ISO 2431	Yes	70 - 370	25 - 100	5 mm
ISO 2431	Yes	130 - 700	25 - 100	6 mm

Comes complete with:

Flow cup
Operating manual
Certificate (except for 7201, 0175, 0176, 0140)

**** Note:** At least one interchangeable orifice must be purchased (0152 through 0158 listed in the accessory table) with the purchase of the 0140 DIN cup.

***Note:** DIN 53211 was withdraw in October 1996

Info!

Information on the flow cup stands please see the accessories page.

Flow Cups

Recommended Accessories

For consistent results temperature control of the sample and flow cup is recommended. The sample should be placed in a water bath for a sufficient time to equilibrate to the test temperature. The Flow Cup Stand with water jacket (7210) can be used to equilibrate the flow cup to the test temperature and maintain the temperature during the measurement.

To check the performance of the flow cup and measurement conditions certified standard oils are available. Please refer to the Viscosity Standard Guide table to select the correct standard oil.



Tripod Stand - 0425



Flow Cup Stand with water jacket - 7210



Ordering Information

Cat. No.	Description
0152	Interchangeable Orifice 2mm
0153	Interchangeable Orifice 3mm
0154	Interchangeable Orifice 4mm
0156	Interchangeable Orifice 6mm
0158	Interchangeable Orifice 8mm
0425	Tripod Stand, for Flow Cups
7210	Flow Cup Stand with water jacket
0420	Ring Stand for Flow Cups
7208	Ford Cup Accessory Kit
0490	Thermometer
0440	Glass Plate
0446	Spirit Level

Accessories

For DIN cup Cat. No. 0140; Stainless steel; 2 mm diameter
For DIN cup Cat. No. 0140; Stainless steel; 3 mm diameter
For DIN cup Cat. No. 0140; Stainless steel; 4 mm diameter
For DIN cup Cat. No. 0140; Stainless steel; 6 mm diameter
For DIN cup Cat. No. 0140; Stainless steel; 8 mm diameter
Holding device for Ford, DIN, and ISO cups
For DIN, ISO, and Ford cups; Closed double wall jacket, hose connection, spirit level, polished glass plate; made of anodized aluminum.
Holding device for any flow cup
For Ford cups; Cover glass for removing excess sample from cup; bubble level for leveling cup and stand; stainless steel beaker; package of cleaning swabs
Measuring range: -10 °C to 110 °C
Spare glass plate with polished rims; Dimensions: 100 x 150 mm (3.9 x 5.9 in)
Spare spirit level for leveling flow cups; for horizontal adjustment of instruments

Certified Standard Oils

BYK-Gardner offers a comprehensive line of certified standard viscosity oils. These oils are used to confirm the drain time of the flow cups are within specification.

Zahn and Ford Flow Cups



Ordering Information

Cat. No.	Description
4000	Viscosity Standard C10
4001	Viscosity Standard C20
4002	Viscosity Standard C35
4003	Viscosity Standard C60
4004	Viscosity Standard C100
4005	Viscosity Standard C200
4006	Viscosity Standard C350
4015	Viscosity Standard C600

Comes complete with:

Viscosity oil
Certificate of Analysis

Note:

Important information about these viscosity standards:
– For practical purpose, these oils are Newtonian liquids
– Standard bottle size is 1 pt. (470 ml).

Technical Specifications

Viscosity Standard	Kinematic Viscosity	Zahn Cup No.	Zahn Cup Drain Time	Ford Cup No.	Ford Cup Drain Time
C10	17 cST	1	45 sec	1	70 sec
C20	34 cST	1	60 sec	2	42 sec
C35	66 cST	2	33 sec	2 / 3	64 / 35 sec
C60	120 cST	2	48 sec	3 / 4	58 / 36 sec
C100	230 cST	3 / 4	27 / 21 sec	4	64 sec
C200	460 cST	3 / 4	47 / 36 sec	5	40 sec
C350	850 cST	4 / 5	62 / 37 sec	5	70 sec
C600	1,600 cST	5	70 sec		

Data Certified at 25°C (77°F)

Viscosity Standard Guide

The following table recommends the Viscosity Standard Oil for the DIN, ISO, Ford, and Zahn cups. The Test Certificate has the flow time values for the listed cups. For example, the Standard C100 test certificate has flow rate times for the ISO 6 mm cup, DIN 4 mm cup, Zahn #3 cup, Zahn #4 cup, and Ford #4 cup.

	ISO Cup	DIN Cup	Zahn Cup	Ford Cup
Standard C10	3 mm		1	1
Standard C20	3 mm		1 & 2	2
Standard C35	4 mm		2	2 & 3
Standard C60	4 mm	4 mm	2	3 & 4
Standard C100	6 mm	4 mm	3 & 4	4
Standard C200	6 mm	4 mm	3, 4, & 5	5
Standard C350			4 & 5	5
Standard C600			5	

Rotational Viscometers

Rotational viscometers have become a standard in virtually all industries. They measure viscosity by sensing the torque required to rotate a spindle at constant speed while immersed in fluid. The torque is proportional to the viscous drag on the spindle; thus the sample viscosity.

Rotational viscometers offer several advantages:

- The continuous rotation of the spindle allows measurements to be made over time, permitting analysis of time-dependent fluids
- The rate of shear is constant, so both Newtonian and non-Newtonian fluids can be tested
- By rotating the spindle at several different speeds, shear dependent behavior can be analyzed

Rotational viscometers are the industry standard in determining absolute viscosity of all types of liquids with viscosities as high as 320 million centipoise. BYK-Gardner offers digital models for low – medium – high viscosity materials.



Selecting the Proper Viscometer

While various models of viscometers are recommended for high, medium, and low viscosity applications, these designations are intended only as guidelines. Multiple speeds and interchangeable spindles on each viscometer provide many viscosity ranges for flexibility in application. Selecting the correct model will ensure maximum sensitivity and accuracy in the measured viscosity range. Some of the factors to consider in selecting a viscometer are: the viscosity range of the samples, sample size, do you need to monitor temperature or do you need to record the viscosity values.

Special Purpose Viscometers

There are two models primarily designed for the Paint and Coatings industries. The KREBS viscosity or Stormer Viscometer that has a fixed speed motor and a paddle style spindle. The KREBS viscometer is designed to comply with ASTM method D562.

For applications that require a higher shear force viscosity measurement the Cone & Plate Viscometers (CAP models) are recommended. The sample is confined between a moving cone-shaped spindle and a plate that applies a higher shear stress and shear rate.



Rotational Viscometers

Typical Applications

Low Viscosity (L)

Range: 20 to 2,000,000 centipoise

Adhesives (solvent); Chemicals; Cosmetics; Hot Waxes; Inks (lithographic); Latex paints; Coating systems; Polymers; Rubber solutions; Solvents

Medium Viscosity (R)

Range: 100 to 13,000,000 centipoise

Adhesives (hot melt); Ceramic slurries; Gums; Inks (screen printing); Paints; Paper coatings; Plastisols; Surface coatings; Varnishes

High Viscosity (H)

Range: 200 to 104,000,000 centipoise

Asphalt; Caulking compounds; Epoxies; Gels; Inks (ballpoint, offset); Pastes; Putty; Roofing compounds; Sealants; Sheet molding compounds

Spindle Geometry

All viscometers are supplied with spindles suitable for most applications. There are situations where specified spindle geometries are necessary to achieve the best results. All spindles are made of stainless steel. In addition, quick couplings and spindle extensions are also available for select spindles; for more information please call customer service.

Disc Spindles

- General purpose applications for accurate and reproducible results
- Included with the L model (spindles #2 and #3)
- Included with the R/H models (spindle #2 through #6)

Cylindrical Spindles

- For most applications involving non-Newtonian fluids such as paints
- Provide a scientifically defined spindle geometry for calculating shear stress and shear rate values to determine viscosity
- Applicable to any model viscometer
- Included with the L (spindles #1 and #4) and R/H (spindle #7) models



T-Bar Spindles

- For measuring non-flowing materials such as pastes, gels, and creams
- Generally used with the Helio Stand

Coaxial Cylinders

- Provide rheological data including shear stress and shear rate values
- Available in several accessories: Small Sample adapter, Low Viscosity adapter, and ThermoChamber

Cone and Plate Geometry

- For accurate determination at high shear rates with very small samples

Rotational Viscometers

byko-visc Basic

The byko-visc Basic viscometer offers multi-functionality at an economical price. The easy to use controls allow for rapid incorporation into the lab. The byko-visc Basic is accurate and precise to meet the demands of today's and tomorrow's laboratory requirements.

- User calibration feature
- Data Display: Speed, % torque, viscosity values (cP or MPa's.), Spindle #, % of full scale
- Auto-Diagnostic check during startup
- 4-Line LCD Display with key board controls
- Audio alarm for out of range measurement values
- Multi-language: English, German, French, Italian, Spanish, Portuguese, Dutch, Polish, Japanese

byko-visc Basic EX

The byko-visc Basic EX has the same features listed with the byko-visc Basic plus more:

- Programable features: Time to torque, Time to stop, Memory - 10 locations
- Temperature measurement with PT100 probe
- Display: Absolute Viscosity, Apparent Viscosity, Kinetic Viscosity (CSt, mm²/sec), Temperature (°C or °F), Shear rate, Shear stress, Density
- Quick connect accessory (QDA) for spindle attachment - also protects motor shaft mechanism
- USB port
- Datalogger function to transfer data to Excel® spreadsheet



byko-visc Basic

Standards

ASTM	D2196,
ISO	2555, 1652
BS	6075, 5350



Ordering Information

Cat. No.	Description
8325	byko-visc Basic L
8326	byko-visc Basic R
8327	byko-visc Basic H
8328	byko-visc Basic EX L
8329	byko-visc Basic EX R
8330	byko-visc Basic EX H

Comes complete with:

byko-visc Viscometer,
Spindle set, Spindle protector, Spindle rack,
Power cable,
Calibration certificate,
2-year warranty,
Operating manual,
Carry case

byko-visc Basic EX additional delivery content:

Quick disconnect accessory,
PT100 probe,
USB port

Technical Specifications

	No. of Spindles	Measuring Range (cP)
	4	60 - 2,000,000
	6	100 - 13,000,000
	6	800 - 106,000,000
	4	60 - 2,000,000
	6	100 - 13,000,000
	6	800 - 106,000,000
Repeatability	0.2%	
Accuracy	1.0% of range	
Speeds / rpm	0.3, 0.5, 0.6, 1.0, 1.5, 2.0, 2.5, 3.0, 4.0, 5.0, 6.0, 10, 12, 20, 30, 50, 60, 100	
Voltage	100 - 240V/ 50-60 Hz	
Dimensions	25 x 31 x 47 cm (9.8 x 12.2 x 18.5 in)	
Instrument Weight	3.25 kg (7.2 lb)	

Rotational Viscometers

byko-visc Advanced

The byko-visc Advanced offers a comprehensive level of features for QC and R&D tasks. The viscometer has an enhanced display with graphics capability.

- User calibration feature
- Data Display: Speed, % full scale, % torque, Spindle #, viscosity values (cP or MPa's), Sample temperature, Shear rate, Shear stress, Density (user entry)
- Auto-Diagnostic check during startup
- LCD Graphical Display with 6 key operation
- 18 speed settings
- Audio alarm for out of range measurement values
- Programable features: Time to torque, Time to stop
- PT100 temperature probe
- Memory 10 locations
- Auto range
- USB interface
- Datalogger function to transfer stored data to Excel® spreadsheet
- Multi-language: English, German, French, Italian, Spanish, Portuguese, Dutch, Polish, Japanese



byko-visc Advanced EX

byko-visc Advanced EX

The byko-visc Advanced EX offers the additional flexibility in speed control and programable features. The EX model has the capability to interface with the byko-visc Software to perform studies on viscosity behavior. The byko-visc Advanced EX has the same features listed with the byko-visc Advanced plus:

- Color LCD display
- Quick disconnect accessory (QDA) for spindle attachment - also protects the motor shaft mechanism
- Enhanced 12 key LCD Display
- 55 speed settings
- Programmable multi-step ramp function
- Interface with optional byko-visc Software

Standards

ASTM	D2196
ISO	2555, 1652
BS	6075, 5350



Ordering Information

Cat. No.	Description
8331	byko-visc Advanced L
8332	byko-visc Advanced R
8333	byko-visc Advanced H
8334	byko-visc Advanced EX L
8335	byko-visc Advanced EX R
8336	byko-visc Advanced EX H

Comes complete with:

byko-visc viscometer, Spindle set, Spindle protector, Spindle rack, Power cable, USB port, Calibration certificate, 2-year warranty, Operating manual, Carry case

byko-visc Advanced EX also includes:

Quick disconnect accessory, PT100 probe

Technical Specifications

No. of Spindles	No. of Speeds	Speed Range (rpm)	Measuring Range (cP)
4	18	0.3 - 100	60 - 2,000,000
6	18	0.3 - 100	100 - 13,000,000
6	18	0.3 - 100	800 - 106,000,000
4	55	0.01 - 250	24 - 6,000,000
6	55	0.01 - 250	40 - 40,000,000
6	55	0.01 - 250	320 - 106,000,000

Repeatability	0.2%
Accuracy	1.0% of range
Voltage	100 - 240 V/ 50-60 Hz
Dimensions	25 x 31 x 47 cm (9.8 x 12.2 x 18.5 in)
Instrument Weight	3.25 kg (7.2 lb)

Rotational Viscometers

byko-visc Premium

The byko-visc Premium viscometer has multi-functional capability for any requirements of Research and Quality Control laboratories. The menu driven programming makes it easy to access all the functions. The color LCD display has excellent image quality to view data. The latest communication technology is standard to transfer data to external devices. The two-way communication with byko-visc Software allows the software to program the instrument and automatically retrieve the data.

- Data Display: Speed, % full scale, % torque, Spindle #, Viscosity values (cP or MPa's), Sample temperature, Shear rate, Shear stress, Density (user entry)
- Auto-Diagnostic check during startup
- Color TFT LCD Graphical Display with 12 key operation
- 2600 speed settings with 18 custom group sets
- Audio alarm for out of range measurement values
- Programmable Features: Time to torque, Time to stop, Multi-step ramp
- PT100 temperature probe
- 9 Memory locations
- Auto range - automatically shows viscosity range with spindle and speed selection
- USB interface, WIFI, Bluetooth
- Datalogger function
- byko-visc Software
- Quick Disconnect accessory (QDA) for spindle changeover
- Multi-language: English, German, French, Italian, Spanish
- User calibration feature



byko-visc Premium

Standards

ASTM	D 2196
ISO	2555, 1652
BS	6075, 5350



Ordering Information

Cat. No.	Description
8337	byko-visc Premium L
8338	byko-visc Premium R
8339	byko-visc Premium H

Comes complete with:

Viscosity head, Stand - with leveling adjustment, Boss head, Spindle set, Spindle protector, Spindle rack, Power cable, USB cable, USB Port, Datalogger function, byko-visc Software, Quick disconnect accessory, PT-100 probe, Calibration certificate, 2-year warranty, Operating manual, Carry case

Technical Specifications

	No. of Spindles	No. of Speeds	Speed Range (rpm)	Measuring Range (cP)
	4	2600	0.01 - 250	24 - 6,000,000
	6	2600	0.01 - 250	40 - 40,000,000
	6	2600	0.01 - 250	320 - 106,000,000
Accuracy	1.0% of range			
Repeatability	0.2 %			
Power Supply	100 - 240 VAC / 50/60 Hz			
Dimension	25 x 31 x 47 cm (9.8 x 12.2 x 18.5 in)			
Instrument Weight	3.25 kg (7.2 lb)			

Viscometer Software

byko-visc Software

The byko-visc Software is designed to work with the byko-visc Advanced EX and the byko-visc Premium models. The software allows for controlling the viscometer from the PC. Viscosity programs can be stored on the PC and the results can be displayed as well as recorded during the operation of the viscometer. For data analysis, results can be reloaded graphically or in a text format. Besides the viscosity values, temperature, % torque, shear rate, shear stress, time, and speed are displayed. The software offers ramp-step and multi-step programing.

- Menu-driven firmware for easy operation
- Full documentation of measurement results including viscometer settings
- Graphical display with zoom feature
- Storing of measurements results in separate database: QC / R&D
- Simultaneous plotting of experiments to compare different flow curves
- Spindle window displays numeric and graphical measurement range of the spindle and model selection
- Math models: Bingham, Casson (Standard), NCA/CMA Casson, Power Law, IPC Paste

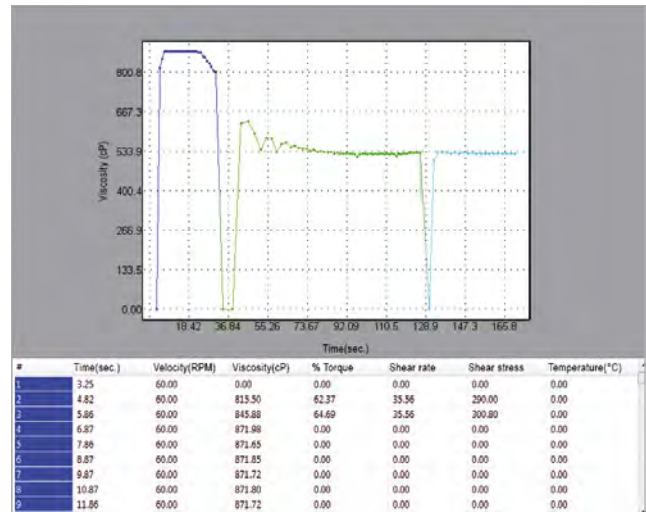

Data analysis display

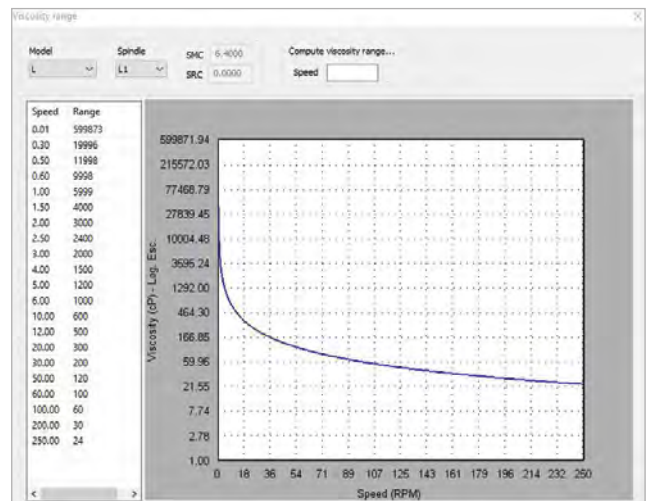

Spindle window display

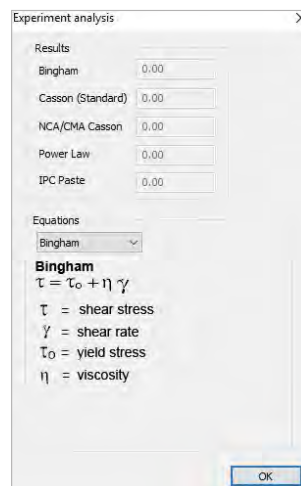

Math model display



Ordering Information

Cat. No.	Description
4980	byko-visc Software

Comes complete with:
 USB Drive, USB Cable, Operating manual

System Requirements:
 Operating system: Windows XP, Vista, 7, 8, 10 (32 bit or 64 bit versions)
 RAM Memory: 32 MB minimum,
 64 MB recommended
 Hard Drive: 10 MB minimum
 Mouse, USB-port

Viscometer Accessories

Standard Spindles

The standard spindles are designed for the byko-visc Basic, Advanced, and Premium viscometer lines. The appropriate spindle set comes standard with the purchase of byko-visc viscometer. All the spindles are made from 316 stainless steel.



Spindle set for R & H Models



Ordering Information

Cat. No.	Description
4981	Spindle set L models, set of 4(L1, L2, L3, L4)
4982	Spindle L1
4983	Spindle L2
4984	Spindle L3
4985	Spindle L4
4986	Spindle Set R & H Models, set of 6 (R2, R3, R4, R5, R6, R7)
4987	Spindle R1
4988	Spindle R2
4989	Spindle R3
4990	Spindle R4
4991	Spindle R5
4992	Spindle R6
4993	Spindle R7

Technical Specifications

For Viscometer type	Viscosity Range (cP)
L	24 - 6,000,000
L	24 - 60,000
L	30 - 300,000
L	70 - 1,200,000
L	400 - 6,000,000
R, H	R: 40 - 40,000,000 H: 50 - 320,000,000
R, H	R: 20 - 100,000 H: 50 - 800,000
R, H	R: 40 - 40,000 H: 200 - 3,200,000
R, H	R: 60 - 1,000,000 H: 500 - 8,000,000
R, H	R: 120 - 2,000,000 H: 1,000 - 16,000,000
R, H	R: 250 - 4,000,000 H: 3,200 - 32,000,000
R, H	R: 600 - 10,000,000 H: 8,000 - 80,000,000
R, H	R: 2,500 - 40,000,000 H: 32,000 - 320,000,000

Note: The viscosity range may vary based on the viscometer model speed range.

Quick Disconnect Accessory

The Quick Disconnect Accessory (QDA) makes the task of changing spindles fast and easy. The coupling system is built into the motor shaft. By pushing up on the coupler the spindle will attach. By releasing the coupler the spindle is firmly set in place. The QDA also protects the motor shaft. The QDA is offered as a standard item with several byko-visc models. Please review the viscometer model information to determine if the QDA is included.



Viscometer Accessories

Low Viscosity Adapter

The Low Viscosity Adapter accessory is used to make accurate and reproducible measurements with low viscosity Newtonian and non-Newtonian materials. This adapter is most commonly used with the L series instruments. The Low Viscosity adapter consists of a precision cylindrical spindle rotating inside a machined tube. Its rheologically correct geometry provides the highest accuracy of viscosity and shear rate.

- For any L and R viscometer models
- Takes measurements as low as 1 cP
- Only 16 - 18 ml of sample needed
- Removable stainless steel sample container easy to clean

The water jacket is made of stainless steel with delrin o-rings and washers. The temperature range is -10 °C (14 °F) to 100 °C (212 °F). An optional temperature probe is an available accessory.



Low Viscosity Adapter with water jacket - 4971

Viscosity Range with Low Viscosity Adapter

Viscosity Range	Viscometer Model	Viscosity Range cP (mPa X s)
Low	byko-visc L models	1.0 - 2,000
Medium	byko-visc R models	5.0 - 21,333



Ordering Information

Cat. No.	Description
4971	Low Viscosity Adapter, with water jacket
4970	Low Viscosity Adapter

Comes complete with:

Spindle, Sample chamber,
Mounting bracket, Hook fasteners,
Carry case, Data sheet
Water Jacket with 4971 only

Technical Specifications

Information
Includes Water Jacket
Water jacket is excluded



Ordering Information

Cat. No.	Description
4973	Temperature Probe, LVA
4972	Spindle, Low Viscosity Adapter

Technical Specifications

Information
For all byko-visc models with temperature probe connection

Viscometer Accessories

Small Sample Adapter

The small sample adapter consists of a stainless steel cylindrical sample chamber and spindle that can handle sample volumes from 8 to 13 ml. The sample chamber is removable allowing for easy clean up without disturbing the set-up of the viscometer. A temperature probe to record the sample temperature is an option.

- Accurate measurement of samples as small as 8 ml
- Precise temperature control with flow jacket ensuring highest accuracy
- Easy change of sample chamber; successive measurements can be made under identical conditions
- Controlled cylindrical geometry allows extremely accurate viscosity, shear rate, and shear stress determinations



Small Sample Adapter with water jacket – 4957



Ordering Information

Cat. No.	Description
4957	Small Sample Adapter, water jacket
4958	Small Small Adapter
4959	Temperature probe, for SSA

Comes complete with:

Carry case, Sample chamber, Mounting plate
 Water jacket included with 4957 only
 Note: TL spindle is not included, need to order separately.

Technical Specifications

Information
Includes water jacket*
Excludes water jacket
For all byko-visc models with temperature probe connection

*Note: Water jacket temperature range is -10 to 100°C (14 to 212°F)



Ordering Information

Cat. No.	Description
4961	Spindle, TL5
4962	Spindle, TL6
4963	Spindle, TL7
4964	Spindle, TR8
4965	Spindle, TR9
4966	Spindle, TR10
4967	Spindle, TR11

Accessories

Model Type	Sample Volume (ml)	Viscosity Range (cP)	Shear rate* (1/s)
L	6.7	5 - 30,000	1.32 x rpm
L	9.0	20 - 300,000	0.34 x rpm
L	9.4	40 - 600,000	0.28 x rpm
R, H	7.1	R 40 - 400,000 H 200 - 3,200,000	0.93 x rpm
R, H	10.4	R 150 - 2,500,000 H 1,200 - 20,000,000	0.34 x rpm
R, H	11.0	R 300 - 5,000,000 H 2,400 - 40,000,000	0.28 x rpm
R, H	13.5	R 600 - 10,000,000 H 4,800 - 80,000,000	0.25 x rpm

*Note: Shear rate calculation is based on Newtonian liquids.

Viscometer Accessories

ThermoChamber Accessory

The byko-visc ThermoChamber Accessory is ideal for high temperature applications involving hot melts such as asphalt, waxes, resins, and adhesives.

- Safe, accurate viscosity measurements of hot materials up to 572 °F (300 °C)
- Extends the versatility of the byko-visc viscometer range from 1.2 cps to 20,000,000 cps
- Programmable temperature control with digital display
- Small sample volume chamber
- Precise temperature control within $\pm 1.5\%$ of temperature setting
- Fast set-up and clean-up with disposable, aluminum sample chambers



Ordering Information

Cat. No.	Description
4975	ThermoChamber, 110V
4976	ThermoChamber, 220V
4977	Sample Chamber, Stainless steel
4978	Disposable Chamber, 50/pack
4979	Extraction tool

Comes complete with:

Temperature controller,
Alignment bracket, Sample chamber,
Tube extension, Extraction tool,
Choice of Spindle (1), Heat shield, Carry case

The spindle selection is based on the Model type (low, medium, high viscosity) and viscosity range.

Technical Specifications

Accessory Item
Accessory Item
Accessory Item



Ordering Information

Cat. No.	Description
4961	Spindle, TL5
4962	Spindle, TL6
4963	Spindle, TL7
4964	Spindle, TR8
4965	Spindle, TR9
4966	Spindle, TR10
4967	Spindle, TR11

Accessories

Model Type	Viscosity Range* (cP)
L	1.2 - 30,000
L	12 - 300,000
L	24 - 600,000
R	20 - 500,000
H	40 - 1,000,000
R	100 - 2,500,000
H	200 - 5,000,000
R	200 - 5,000,000
H	400 - 10,000,000
R	400 - 10,000,000
H	800 - 20,000,000

***Note:** The viscosity range is based on the byko-visc Premium speed selections. Please contact your BYK-Gardner representative for the viscosity range for your viscometer.

Viscometer Accessories

byko-visc Helio Stand

The byko-visc Helio Stand is designed to lower and raise the viscometer so that the rotating shearing element will trace a helical path through the test sample. By always cutting into fresh material the T-bar spindle remains in contact with the sample. The reversing feature of the Helipath stand allows measurements to be made over a short period of time.

- Relative viscosity measurements of non-flowing substances such as gels, pastes, paint dyes, and inks
- Slowly raises and lowers the viscometer to always maintain contact with sample material

Model Type	Viscosity Range (cP)
L (Low Viscosity)	4,680 - 1,872,000
R (Mid-range viscosity)	16,600 - 33,300,000
H (High Viscosity)	130,000 - 260,000,000



Ordering Information

Cat. No.	Description
4968	Helio Stand, 110V
4969	Helio Stand, 220V

Comes complete with:

Automated motor, Spindle connector, Set of 6 T-bar spindles, Stop rings (2), Counter-weight, Rib joint, Power cord, Fastening bolt, Carry case

Technical Specifications

For use with rotational viscometers

For use with rotational viscometers

Circulating Bath

For precise and accurate viscosity measurement, controlling the sample temperature is critical. BYK-Gardner offers a refrigerated circulating bath to cool or warm the sample to the specified temperature. The sample container can be placed into the bath. The low profile design allows for the rotational viscometer to be placed next to the bath to test the sample in the bath. For viscometers with water jackets, the bath has a pressure pump with external (closed-loop) circulation capability. There is a visual alarm when the temperature is outside the pre-set limits. The bath complies with DIN 12876-1 Class 1 safety requirements for use with non-flammable liquids.



Ordering Information

Cat. No.	Description
4994	Water Bath, 120V, 60Hz
4995	Water Bath, 240V, 50Hz

Comes complete with:

Controller with digital display, Lid, Bath, Single-speed pressure pump, Power cord

Technical Specifications

Bath Capacity	Temperature Range	Maximum Flow Rate	Maximum Pressure
7.0 Liter	-20° to 135°C -4° to 275°F	12.8 L/min. 3.4 gal/min.	0.12 bar 1.80 psi
7.0 Liter	-20° to 135°C -4° to 275°F	10.6 L/min. 2.8 gal/min.	0.10 bar 1.50 psi
Dimensions	58.9x41.1x43.9 cm 23.2x16.2x17.3 in		
Temperature Stability	± 0.07°C		

byko-visc DS

Stormer Type Viscometer

The byko-visc DS has a direct digital readout of Krebs units (KU), centipoise (cP), and grams (gm). The instrument rapidly calculates viscosity values. The digital stormer maintains the rotational speed at 200 rpms in compliance with ASTM D 562. The viscometer automatically starts and stops the motor shaft rotation by lowering or raising the instrument stand.

- Easy to use - automatic rotational speed control
- Automatically calculates KU, centipoise, and gram units
- Printer interface for test report output
- Instrument base accessory to fit quart, pint, 1/2 pint containers
- Calibrated with NIST traceable oils
- Universal power supply - One model for global use



Standards

ASTM D 562, D 2337,
D 2243, D 1849



Ordering Information

Cat. No.	Description
8324	byko-visc DS

Comes complete with:

Viscometer,
1 paddle spindle,
Adapter for 1 pint,
1/2 pint containers,
Operation Manual
Calibration certificate,
Two year warranty

Accessories

Cat. No.	Description
8340	Spindle, byko-visc DS

Technical Specifications

Range	Resolution	Accuracy	Repeatability	Spindle Speed
40-141 KU;	0.1 KU;	within $\pm 1\%$	within $\pm 0.5\%$	200 rpm
32-1090 grams;	1.0 gm;	full scale	full scale	± 0.1 rpm
27-5274 cP*	0.7 cP			

Voltage	100 - 230V/ 50-60Hz
Operating Temperature	10 - 40 °C (50 - 104 °F)
Dimensions	20 x 11 x 15 in
Shipping Weight	10 kg (20 lbs)

*Note: Centipoise values are based on the conversion from Krebs Units as defined in the ASTM standard D562

Cone and Plate Viscometer

The versatility of the CAP 1000+ and CAP 2000+ makes these instruments a practical tool for any QC or R&D lab requiring quick and easy testing of materials, regardless of application, at high shear rates.

- Provides for viscosity measurements at high shear rates
- LCD display of viscosity in Poise or Pascal-seconds
- Uses less than 2 ml of sample to avoid excess cleaning and material costs
- Automatic viscosity range calibration and cone gap positioning make the viscometer easy to use
- Set the viscometer to take a reading at different timed intervals to ensure accuracy of results with thixotropic fluids

CAP 1000+

- Two available speeds to comply with all paint industry standards worldwide (750 and 900 rpms), optional speed of 400 rpm upon request.

CAP 2000+

- Variable speed instrument with a speed range of 5 to 1,000 rpm (1 rpm increments) that allows for varying shear rates from 10 to 13,300 sec⁻¹
- Bi-directional RS-232 interface that allows for PC control with the optional CAPCALC 32 software



Standards

ASTM	D 4287
ISO	2884
BS	3900



Ordering Information

Cat. No.	Description	Technical Specifications						
		Temperature Range	Viscosity Poise	Speeds rpm	Accuracy	Shear Rate sec ⁻¹	Voltage	RS-232 Interface
7552	CAP 1000+ L, 115V	5 - 75 °C	0.25 - 100	750 or 900	± 2 % of full scale	up to 13,300	115V/60Hz	
7553	CAP 1000+ L, 230V	5 - 75 °C	0.25 - 100	750 or 900	± 2 % of full scale	up to 13,300	230V/50Hz	
7557	CAP 1000+ H, 115V	50 - 235 °C	0.25 - 100	750 or 900	± 2 % of full scale	up to 13,300	115V/60Hz	
7558	CAP 1000+ H, 230V	50 - 235 °C	0.25 - 100	750 or 900	± 2 % of full scale	up to 13,300	230V/50Hz	
7550	CAP 2000+ L, 115V	5 - 75 °C	0.2 - 15,000	5 - 1,000	± 2 % of full scale	10 - 13,300	115V/60Hz	X
7551	CAP 2000+ L, 230V	5 - 75 °C	0.2 - 15,000	5 - 1,000	± 2 % of full scale	10 - 13,300	230V/50Hz	X
7555	CAP 2000+ H, 115V	50 - 235 °C	0.2 - 15,000	5 - 1,000	± 2 % of full scale	10 - 13,300	115V/60Hz	X
7556	CAP 2000+ H, 230V	50 - 235 °C	0.2 - 15,000	5 - 1,000	± 2 % of full scale	10 - 13,300	230V/50Hz	X

Comes complete with:

Cone & Plate Viscometer
1 cone – please specify
Operation manual

Note: Specify cone number when ordering. Will need to order the appropriate viscosity oil to calibrate the CAP viscometer.

Timed Readings

Digital timer with continuous running override; range 15 to 99 seconds

Temperature Control

Increments of 0.1 °C

Printer Interface

parallel centronic

Dimension

26 x 18 x 19 in

Shipping Weight

20 kg (46 lbs)

1/23 CAP Version

Cone and Plate Viscometer

The 1/23 CAPs are for lower shear applications such as automotive clear coats and base coats. Most methods are single point pass/fail criteria using No. 10 spindle at 100 rpm; a shear rate of 500 1/sec and measurement range from 22 – 220 cP is achieved. There are two instruments available:

- 1000+L version with a fixed speed of 100 rpms
- 2000+L version with a speed range from 5 – 1000 rpms
- The multiple speed selection provides more flexibility to modify test procedures.

Standards

ASTM	D 7395
ISO	2884, 3900



Ordering Information

Cat. No.	Description	Technical Specifications						
		Temperature Range	Viscosity Poise	Speeds rpm	Accuracy	Shear Rate sec-1*	Voltage	RS-232 Interface
7590	1/23 CAP 1000+ L, 115V	5 - 75 °C	0.22 - 2.20	100	± 2 % of full scale	500	115V/60Hz	
7591	1/23 CAP 1000+ L, 230V	5 - 75 °C	0.22 - 2.20	100	± 2 % of full scale	500	230V/50Hz	
7595	1/23 CAP 2000+ L, 115V	5 - 75 °C	0.2 - 44.0	5 - 1,000	± 2 % of full scale	25 - 5000	115V/60Hz	X
7596	1/23 CAP 2000+ L, 230V	5 - 75 °C	0.2 - 44.0	5 - 1,000	± 2 % of full scale	25 - 5000	230V/50Hz	X

Comes complete with:

1/23 Cone & Plate viscometer
No. 10 spindle
Operation manual

*Note: with the No. 10 spindle

Spindles for Cone and Plate Viscometers



Ordering Information

Cat. No.	Description	Accessories		
		Cap 1000+ 750rpm	Cap 1000+ 900rpm	Cap 2000+
7531	CAP Spindle No. 1	0.25 - 2.5 poise	0.2 - 2 poise	0.2 - 375 poise
7532	CAP Spindle No. 2	0.5 - 5 poise	0.4 - 4 poise	0.4 - 750 poise
7533	CAP Spindle No. 3	1 - 10 poise	0.8 - 8 poise	0.8 - 1500 poise
7534	CAP Spindle No. 4	2 - 20 poise	1 - 16 poise	1 - 3000 poise
7535	CAP Spindle No. 5	4 - 40 poise	3 - 33 poise	3 - 6000 poise
7536	CAP Spindle No. 6	10 - 100 poise	8 - 83 poise	8 - 15000 poise
7560	CAP Spindle No. 7	N/A	N/A	0.78 - 625 poise**
7561	CAP Spindle No. 8	N/A	N/A	3.13 - 2500 poise**
7562	CAP Spindle No. 9	N/A	N/A	12.5 - 10000 poise**
7563	CAP Spindle No. 10	N/A	N/A	1.0 - 1000 poise**

**Note: Maximum speed recommended with this spindle is 400 rpm.

The viscosity range indicated is for operation at 400 rpm

Note: 1 Poise = 100 cP; 1 cP = 1 mPa*s

Software for Cone and Plate Viscometers

CAPCALC 32

Software for CAP 2000+

Turn your CAP2000+ Viscometer into a sensitive, accurate rheometer. When advanced sample analysis is required, CAPCALC can control the viscometer from any PC to provide automatic data capture and graphical display to facilitate analysis of test samples.

- Automates data collection
- Eliminates operator error when recording data
- Provides instantaneous viscosity flow curves (rheograms) on easy-to-read graphs
- Creates a permanent record of each test
- Records up to 1000 data points per test
- Comparison data sets can be manually entered
- Saved data in Brookfield (text), Lotus 1-2-3, or Excel®
- Up to 6 data sets may be plotted simultaneously
- 12 Plot Types:
 - % FSR vs. RPM, Shear Rate, Time, Temperature
 - Viscosity vs. RPM, Shear Rate, Time, Temperature
 - Shear Stress vs. RPM, Shear Rate, Time, Temperature
- Yield Stress Calculations (Bingham Plastic, Casson, Chocolate Casson), Power Law Consistency Index Calculations, Paste Analysis
- On-line help system
- Data collection is provided via a powerful “scripting” language for creating test programs

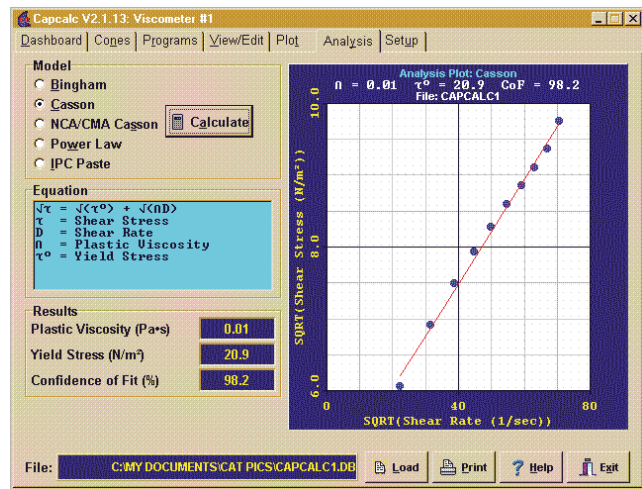

Ordering Information

Cat. No.	Description
7524	CAPCALC 32 Software

Comes complete with:

- CD-ROM
- Connecting cable
- Operating manual

Technical Specifications

Computer Requirements

500 mHz processor, MS-Windows, 2000, XP, Vista, 7, 8, 10, RS-232 port, 256 MB RAM, 800 x 600 Resolution display, One RS-232 Port 800x600 resolution display

CAP Viscometers – Certified Standard Oils

To properly calibrate the CAP 1000 and CAP 2000 viscometers a calibration oil is required. The correct oil is based on the spindle number, temperature range, and torque of the CAP model. If more than one spindle is used, each spindle needs a calibration oil.

High Torque CAP – Oils



Ordering Information

Technical Specifications

Cat. No.	Description	Cone #	Viscosity	Temperature
For Low Temperature CAP Viscometers (5° - 75°C)				
7570	Viscosity Standard CAP1L	1	89 cP	25 °C
7571	Viscosity Standard CAP2L	2	177 cP	25 °C
7572	Viscosity Standard CAP3L	3	354 cP	25 °C
7573	Viscosity Standard CAP4L	4	708 cP	25 °C
7574	Viscosity Standard CAP5L	5	1,417 cP	25 °C
7575	Viscosity Standard CAP6L	6	3,542 cP	25 °C
7576	Viscosity Standard CAP7L	7	1,328 cP	25 °C
7577	Viscosity Standard CAP8L	8	5,313 cP	25 °C
7578	Viscosity Standard CAP9L	9	21,250 cP	25 °C
7579	Viscosity Standard CAP10L	10	236 cP	25 °C
For High Temperature CAP Viscometers (50° - 235°C)				
7580	Viscosity Standard CAP1H	1	89 cP	60 °C
7581	Viscosity Standard CAP2H	2	177 cP	60 °C
7582	Viscosity Standard CAP3H	3	354 cP	60 °C
7583	Viscosity Standard CAP4H	4	708 cP	60 °C
7584	Viscosity Standard CAP5H	5	1,417 cP	60 °C
7585	Viscosity Standard CAP6H	6	3,542 cP	60 °C
7586	Viscosity Standard CAP7H	7	1,328 cP	60 °C
7587	Viscosity Standard CAP8H	8	5,313 cP	60 °C
7588	Viscosity Standard CAP9H	9	21,250 cP	60 °C
7589	Viscosity Standard CAP10H	10	236 cP	60 °C

Comes complete with:

4 oz bottle (125 ml); Test Report

Note: The CAP oil certification is valid 24 months from the time the bottle is opened.

Low Torque CAP – Oils



Ordering Information

Technical Specifications

Cat. No.	Description	Cone #	Viscosity	Temperature
For Low Temperature CAP Viscometers (5° - 75°C)				
7592	Viscosity Standard CAP0L	1	57 cP	25°C
7570	Viscosity Standard CAP1L	2	89 cP	25°C
7571	Viscosity Standard CAP2L	3	177 cP	25°C
7572	Viscosity Standard CAP3L	4	354 cP	25°C
7573	Viscosity Standard CAP4L	5	708 cP	25°C
7574	Viscosity Standard CAP5L	6	1,417 cP	25°C
7570	Viscosity Standard CAP1L	7	89 cP	25°C
7572	Viscosity Standard CAP3L	8	354 cP	25°C
7574	Viscosity Standard CAP5L	9	1,417 cP	25°C
7571	Viscosity Standard CAP2L	10	177 cP	25°C
For High Temperature CAP Viscometers (50° -235°C)				
7593	Viscosity Standard CAP0H	1	57 cP	60°C
7580	Viscosity Standard CAP1H	2	89 cP	60°C
7581	Viscosity Standard CAP2H	3	177 cP	60°C
7582	Viscosity Standard CAP3H	4	354 cP	60°C
7583	Viscosity Standard CAP4H	5	708 cP	60°C
7584	Viscosity Standard CAP5H	6	1,417 cP	60°C
7580	Viscosity Standard CAP1H	7	89 cP	60°C
7582	Viscosity Standard CAP3H	8	354 cP	60°C
7584	Viscosity Standard CAP5H	9	1,417 cP	60°C
7581	Viscosity Standard CAP2H	10	177 cP	60°C

Comes complete with:

4 oz bottle (125 ml); Test Report

Note: The CAP oil certification is valid 24 months from the time the bottle is opened.

Rotational Viscometer Oils

The certified oils are used to determine if the viscometer is measuring within the specified performance range. These oils are for rotational-type viscometers with cylinder, disk, or rod shaped spindles.



Ordering Information

Cat. No.	Description
4996	Viscosity Standard RT5
4040	Viscosity Standard RT10
4041	Viscosity Standard RT50
4042	Viscosity Standard RT100
4043	Viscosity Standard RT500
4044	Viscosity Standard RT1000
4045	Viscosity Standard RT5000
4046	Viscosity Standard RT12500
4047	Viscosity Standard RT30000
4048	Viscosity Standard RT60000
4049	Viscosity Standard RT100000

Technical Specifications

Approx. Viscosity 25°C
4.7 cP
9.4 cP
48 cP
96 cP
480 cP
960 cP
4,800 cP
12,000 cP
29,000 cP
58,000 cP
97,000 cP

Note: Important information about these viscosity standards: – For practical purpose, these oils are Newtonian liquids – Standard bottle size is 1 pt. (470 ml).

Stormer-Type Viscometer Oils

The Digital Stormer (DS) certified oils are used to determine, if the viscometer is measuring within the specified performance range.



Ordering Information

Cat. No.	Description
4020	Viscosity Standard S200
4021	Viscosity Standard N350
4022	Viscosity Standard K400
4023	Viscosity Standard S600
4024	Viscosity Standard N1000

Technical Specifications

Viscosity	Krebs Units
400 cP	61.2
750 cP	73
940 cP	84
1,100 cP	91
2,000 cP	106

Data Certified at 25°C (77°F)

Note: Important information about these viscosity standards: – For practical purpose, these oils are Newtonian liquids – Standard bottle size is 1 pt. (470 ml).



Touch the color with our new spectro2guide:

There it is in black and white: The new spectro2guide has arrived. The revolution in color management.



Upfront design. Color touchscreen. Camera preview. Auto calibration. Gloss. Fluorescence. Digital standard...

www.touchthecolor.com



Appearance

Color

Physical Properties

TECHNICAL SERVICE

Technical Service

Index

Global Calibration and Repair Service

Sustaining your satisfaction with your product is our key target. BYK-Gardner is a global company with local customer care, sales and application support as well as certified technical service centres. This ensures the best local support before and after the sale.

BYK-Gardner authorized service centers – protect your invest.

Only at our authorized service centers, you are ensured that original mechanical, optical and electronic components are used for repair. The working standards are traceable to the manufacturer's calibration chain and routinely recertified. Here the final check is performed with BYK-Gardner specific service software to ensure all components are precisely coordinated with each other. Thus, the documented technical specifications are the same as for a brand new instrument.

BYK-Gardner ISO/IEC 17025 accredited

We even offer a global network of ISO/IEC 17025 accredited service laboratories with the full line of reference standards and tools needed to perform premium services - You don't get more professionalism anywhere else!



We want to make sure that your instruments function correctly and reliably after many years in operation.

Extended Warranty – for extra peace of mind

Protect your invest for an additional year and avoid unnecessary costs. For a small fee we extend our manufacturer's warranty. You will continue to benefit from the short service response times of our highly skilled service team, which is specialized in the maintenance and repair of BYK-Gardner instruments.

Preventive Maintenance with Certificate

Ensure the reliability of your quality control system with regular inspections. A traceable certificate is included to give you confidence in the measurement results.

Certification Services of Standards

Traceable working standards for color and appearance are the basis for your own internal references.

Repair Service

With BYK-Gardner's Repair Service your instrument will always be brought to use. After all, as the manufacturer of the instruments we know every unit in detail. This enables us to repair faulty instruments to the same high quality as we build new instruments.

On-site Service

Preventive maintenance and "simple" repairs can be performed on-site - all we need is a temperature and humidity controlled lab. Our trained technical service engineer will bring certified service standard sets and service software to check the technical performance – even a certificate of traceability can be issued. It will save you work to create paperwork for shipping the instrument to your local service center and minimize your downtime. This is especially of interest, if several instruments need service - a very efficient alternative.

Preventive Maintenance for a Long Life

Increase the reliability of your instrument with regular inspections and optimization – with our Preventive Maintenance solutions your instrument will always be in best shape.

A complete check-up makes sure that your instrument's hardware functions work properly and your software is up-to-date. The technical performance in regards to repeatability and inter-instrument agreement is tested and has to meet the documented specifications as if it was a new instrument. A traceable certificate documents the performance.

Preventive Maintenance includes:

- Thorough cleaning of optical system
- Comprehensive test of instrument functionality: Anything from simple functioning of "operate buttons" to complex technical performance check
- Control of technical specification to meet repeatability and inter-instrument agreement.
- Firmware and Software update
- Control of calibration and checking standards
- Factory calibration certificate or traceable ISO/IEC 17025 certificate
- Inspection sticker



Your benefits:

- Reliable measurement results
- In compliance with international standards
- Less total costs of ownership
- A long instrument's life



Contact your local authorized service center for ON-SITE Preventive Service or if a loaner unit is needed during the maintenance service.

Preventive Maintenance for a Long Life

After cleaning, testing and updating the final inspection is performed on a set of reference standards. We are committed offering globally, at our authorized service locations, a full range of reference standards, which are certified by international institutes or traceable to the manufacturer's specification.

Preventive Maintenance for gloss meters



Depending on the technical facilities of the service center, either a Premium or Standard Service is offered for all gloss geometries: 20°/60°/85° - 45° - 75° as well as mirror gloss and reflection haze:

The **Premium Service** uses a full range of 25 reference standards for calibration and final check. The technical performance is tested the same way as for a brand-new instrument and even allows a re-calibration. This service is only offered by BYK-Gardner ISO/IEC 17025 accredited service laboratories (see page 336) including a traceable ISO/IEC 17025 certificate.

The **Standard Service** is performed on a set of 5 gloss standards. If the service is performed by an ISO/IEC accredited laboratory, a traceable certificate is included. All other authorized service centers will issue a factory calibration certificate to document the test results on the reference standards.

Preventive Maintenance for cloud-runner



BYK-Gardner is the industry standard for measurement of mottling. A specially developed set of reference standards controls the technical specifications for the various mottle sizes.

Preventive Maintenance for wave-scan



BYK-Gardner is the industry standard for orange peel and DOI. A specially developed set of reference standards evaluates the technical specifications for dullness, waviness values (Wa-We) as well as LW, SW. Thus, all customer specific scales offered in the wave-scan are accurately calculated and reliable data are guaranteed.

Preventive Maintenance for haze-gard

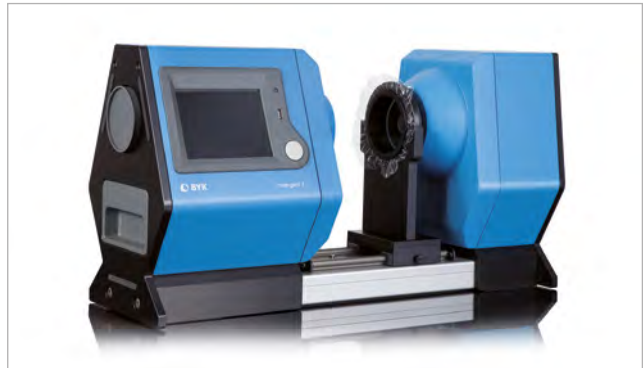

In order to check total transmission T_t a set of transmission standards is used with transmission levels from 90 – 60%. The transmission haze set evaluates the wide-angle scattering behavior according to ISO and ASTM standards within a haze range of 1% - 30%. In order to control the see-through quality of a transparent product (Clarity), BYK-Gardner developed special standards with a narrow-angle scattering behavior.

Info! For more details please check on www.byk.com

Preventive Maintenance for spectro-guide



The accuracy and reliability of the spectro-guide is tested using a set of color standards located in all 4 quadrants of the CIELAB color space. The results on the reference tiles as well as the spectral remission and colorimetric data of the white instrument calibration standard are recorded on the certificate.

Preventive Maintenance for light booths



Light booths made by BYK-Gardner or any other brand can be re-certified on-site. If a light source is not within specifications defined by CIE Publication 51, a lamp replacement will be performed.

Preventive Maintenance for BYK-mac



In the final inspection step of the BYK-mac the authorized service centers use with the BYK-Gardner service software a set of solid and gonio-chromatic colored tiles to ensure reliable color data throughout the color space at all measurement angles (-15°, 15°, 25°, 45°, 75°, 110°). The certificate documents the measurement results on achromatic and chromatic color tiles as well as the spectral remission and colorimetric data of the instrument white calibration standard.

Preventive Maintenance for Physical Test Products



On the following products a preventive maintenance check is offered:

- Electronic Film thickness gauges*
- BYK LC2, Conductivity meter*
- temp-gard, oven recorders*
- byko-drive, automatic film applicator

* includes factory calibration certificate or traceable ISO/IEC17025 certificate

Info!

For more details please check on www.byk.com

Certification Services for Standards

Whether motivated by regulatory requirements or the need for assurance of correct and reliable measurements a regular certification of your working standards to a certified reference standard is critical to a manufacturing process according to ISO 9001 guidelines.

Our master standards for color and appearance are sent for recertification to international institutes on a routine basis as defined in our ISO/IEC 17025 guidelines. A clearly documented chain of calibration including master instruments to create working standards for production and local service standards controls the maintenance at all BYK-Gardner authorized service centers.



Certification Service for color and appearance standards includes:

- Inspection and documentation of standard condition as received
- Measurement of standard with master instrument
- Cleaning of standard
- Factory calibration certificate or traceable* certificate
* offered by BYK-Gardner ISO/IEC 17025

Certification Service for physical testing tools:

We also offer for "Density cups" as well as "Viscosity Cups" a dimensional check based on specifications defined in corresponding international standards.

Traceable reference standards

- **Gloss standards** traceable to BAM (Bundesanstalt für Materialforschung und -prüfung, Berlin, Germany) and NRC (National Research Institute of Canada)
- **Color standards** for solid and multi-angle color measurement traceable to NRC (National Research Institute of Canada, NPL (National Physical Laboratory, UK) and PTB (Physikalisch-Technische Bundesanstalt, Germany)
- **Orange Peel and DOI standards** traceable to BYK-Gardner internal reference standards
- **Mottling standards** traceable to BYK-Gardner internal reference standards
- **Total transmission, haze standards** traceable to NIST (National Institute of Standards and Technology, USA)

Your benefits:

- Traceable working standard as reference to check performance of instrument
- Smallest measurement uncertainties for best performance
- Fair and realistic calibration appraisals
- Accredited laboratories

Info!

For more details please check on www.byk.com

Repair Service

With BYK-Gardner's Repair Service you can be ensured that we will do our best to bring your instrument back to use. After all, as the original manufacturer we know every unit in detail and can replace any component. This enables us to repair faulty instruments to the same high quality as we build new instruments.

Our local, certified service centers are trained on a routine basis to guarantee high quality service on a global basis. Their service labs are equipped with latest calibration tools, service software tools and certified working standards. Their testing tools are part of our global calibration chain and controlled on a regular basis according to our internal working guidelines according to ISO/IEC 17025. A common stock of spare parts guarantees you a fast turn-around-time.

Our Repair Service includes:

Step 1

- Repairs management
- Diagnosis of source of error
- Rectifying errors and consequently testing functionality of replaced part
- Detailed repair report describing error and corrective measures
- Quick, simple, high-quality order processing

Step 2

- Firmware and Software update
- Control of measuring instrument with certified working standard set
- Control of calibration and checking standards
- Traceable Certificate

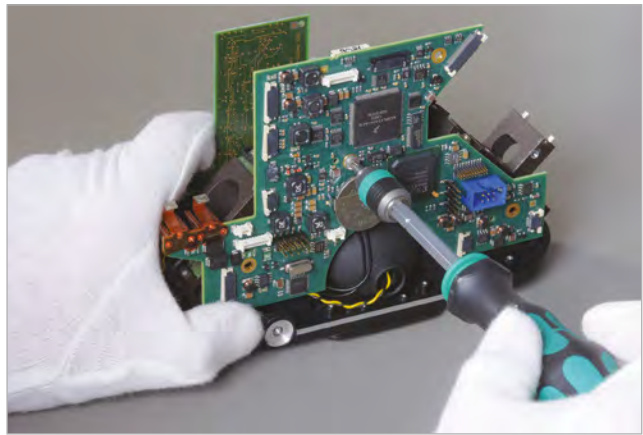

Your benefits:

- Quick return to operational availability of your instrument
- Cost control due to fair and realistic service appraisals
- Quick turn-around time or loaners on request to minimize downtime
- warranty on repair...

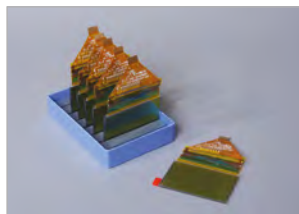
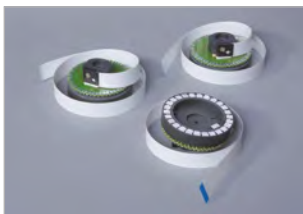



BYK-Gardner global service centers with ISO/IEC 17025 accredited laboratories

BYK-Gardner Service Point Germany

c/o BYK-Gardner GmbH
 Lausitzer Straße 8
 82538 Geretsried
 Germany
 Tel. +49-8171-3493-321

BYK-Gardner Service Point USA

c/o BYK-Gardner USA
 9104 Guilford Road
 Columbia, MD 21046
 USA
 Tel. +1-301-483-6500

BYK-Gardner Service Point Spain

c/o BYK-Gardner Office Spain
 Carrer Balmes, 8
 08291 Ripollet
 Spain
 Tel. +34-936-914-497

BYK-Gardner Service Point France

c/o BYK-Gardner France Office
 31 Rue Amilcar Cipriani
 93400 Saint Ouen
 France
 Tel. +33-1-49-51-01-02

BYK-Gardner Service Point China

c/o BYK-Gardner GmbH Shanghai
 Representative Office
 Block 6A, Building A, No 88 Hong Cao Road,
 Xuhui District, Shanghai 200233, P.R China
 Tel. +86-21-3367-6330

BYK-Gardner Service Point UK and Ireland

c/o BYK-Gardner Office UK
 450 Bath Road
 Longford, Heathrow, UB7 0EB
 United Kingdom
 Tel. +800-9178298

BYK-Gardner Service Point Latin America

c/o Mast Comercial E Importadora Ltda
 Rua Itaporanga, 340-B
 Bairro Paraiso
 Santo André SP, 09190-640
 Brazil
 Tel. +55-11-2147-1199

BYK-Gardner Service Point Japan

c/o Tetsutani & Co. Ltd
 2-2-2 Tokui cho Chuo-ku
 Osaka
 Japan
 Tel. +81-6-6941-9071

BYK-Gardner Service Point Austria, Hungary, Slovenia

c/o Friedrich W. Bloch GmbH
 Dresdnerstraße 109
 1200 Vienna
 Austria
 Tel. +43-1-332-3530-22

BYK-Gardner Service Point India

c/o Premier Colorscan Instruments PVT. Ltd
 EL 130, Electronic Zone, M.I.D.C. Mahape,
 Navi Mumbai – 400710 India
 Tel. +91-22-2763-7900

Please find the complete list of certified service centers on byk.com

Product Index from A–Z

45/0 geometry	82	Brush for Cross-Cut Tester	160
4-Sided Applicator	178	Brushout Cards	173
		Bubble Viscometers	267 - 269
		empty tubes	268
		tube holder	268
		Buchholz Indentation Hardness	222
Abrasers	149 - 156	Buchholz Indentation Tester	224
Abrasion	149 - 150	precision microscope	224, 246
Abrasion Scrub Tester	155 - 156	BYK LC 2	199
Abrasion Scrub Tester accessories	156	BYK-Gardner Cupping Tester	239
Abrasion Tester brush	156	BYK-Gardner DIN EN ISO Impact Tester	231 - 232
Abrasion Tester modification kit	156	BYK-Gardner Drying Time Recorder	204
Abrasion Tester pad	156	BYK-Gardner Film Casting Knife	181
Abrasion Tester panels	156	BYK-Gardner Liquid Color Standards	128 - 129
Acculab Balances	193 - 197	BYK-mac i	105 - 120
Adhesion	157 - 165	accessories	110
Adhesion testers	159 - 165	accessories cosmetics	111 - 114
addista color standards	134	docking station	110 - 117
Adjustable drawdown bars	181	protective cap	110 - 117
Adjustable knives	181	USB interface cable	110 - 117
Anti-Sag Meter	187	white calibration standard	109, 116, 119
APHA	127 - 132	software smart-lab	110, 124 - 125
Appearance	11 - 65	software smart-process	110, 121 - 123
Application	167 - 190	WiFi adapter	106
Application Device for gradient-oven panels	254	BYK-mac i COLOR	115 - 117
Applications, gradient-oven	255 - 258	BYK-mac i ROBOTIC	122 - 124
Applicator Frame	178	byko-charts	169 - 175
Applicator, automatic	190 - 191	byko-cut universal	218 - 220
Applicators	177 - 187	accessories	220
Automatic Appearance Control	49	byko-drive Automatic Film Applicator	190 - 191
auto-match III Sensor	99	byko-drive XL	191
Automatic Film Applicator	190 - 191	byko-spectra	139 - 144
accessories	177 - 187	replacement lamp kit	143
		byko-spectra basic	144
		byko-spectra effect	139
		byko-spectra family	139 - 144
Balanced Beam Scrape Adhesion and Mar Tester	162	byko-spectra lite	143
accessories	162	byko-spectra mini	144
Bar Film Applicators	177	byko-spectra pro	140 - 141
Barrier for temp-gard pro	259	byko-spectra standard	142
Balances	193 - 197	byko-test	212 - 214
Analytical	194 - 197	byko-test 4500 / 4200	212
Entris Series	194 - 195	byko-test 8500	213 - 214
Sartorius Quintix Series	196 - 197	accessories	214
Baking ovens	250	calibration shims	214
Bend Test	227, 240 - 241	sensor	214
Bending testers	240 - 241	software	214
Black Glass Panel	176	byko-test Thickness Gages	212 - 215
Books	242	byko-visc	280 - 283, 289
Brightenend Charts	170	basic	280
Brilliance	14	basic EX	280
Brush for Abrasion Tester	156	advanced	281

Product Index from A–Z

advanced EX	281	Color Measurement of small parts	107
premium	282	Color Quality Control of Liquids	127 - 135
DS	289	Color Standards, liquid	128 - 129
BYKWARE easy-link	34	Color system	81
BYKWARE temp-chart <i>pro</i>	260	Comb gages	209
		Comparators, Color	128 - 130
		Conductivity	198
		Conductivity Measuring Cell	198
		Conductivity Meter	198
Calibration Holder for micro-gloss	29	Conductivity Plate electrode	198
Calibration Holder for micro-TRI-gloss	29	Conductivity Tube electrode	198
Calibration Holder for micro-TRI-gloss μ	216	Cone and Plate Viscometers	290 - 292
Calibration Shims for byko-test 8500	214	Cone and Plate Viscometer Spindles	291
Calibration Shims, Film Thickness	214, 217	Conical Mandrel	241
Calibration Standards, Film Thickness	214, 217	Coverage testing	188
CAP 1/23	291	Coverall Bend and Impact Tester	237
CAP 1000+	290	Cross-Cut Test	157 - 158
CAP 2000+	290	Cross-Cut Tester	159
CAPCALC Software for CAP 2000+	292	accessories	160
Cards	169 - 175	brush	160
Certification for Adhesion	273 - 274	Cross-Cut Tester Blade	159 - 160
Cloudiness	57	magnifier	160
cloud-runner	58 - 60	Cryptometer	188
Charts	169 - 175	Cup, density	200 - 201
Checkerboard Charts	172	Cup, DIN	274
Checking Standard for haze-gloss	34	Cup, DIN EN ISO	271
Checking Standard for micro-gloss	27	Cup, Ford Viscosity	274
Checking Standard for micro-TRI-gloss	34	Cup, specific gravity	200
Checking Standard for micro-TRI-gloss μ	29, 244	Cup, weight per Gallon	200
Checking Tile for micro-wave-scan	48	Cupping Test	228, 238 - 239
Checking Tile for wave-scan II	45	Cupping Tester	238 - 239
Checking Tile for wave-scan dual	42	stereo microscope	239
Checking Tile for wave-scan ROBOTIC	50	Cups, accessories	276
Checking Tile for wave-scan ROBOTIC dual	50	Cups, Viscosity	270 - 277
Chromolux Cards	173	Curing time, recorder	204
CIELab	81	Cylindrical Mandrel	240
Circulating Bath	288		
Clarity Calibration Standard for haze-gard i	75	Datalogger temp-gard	259 - 262
Clarity Reference Standard for haze-gard i	75	Degree of Dispersion	32
Clear Polyester Film	176	Delta Color Comparator	130
Coating Inspection gages	218 - 219	Density	200 - 201
Color	77 - 144	Density Cup	200 - 201
Color and Gloss	84	Destructive Film Thickness Gages	218 - 220
Color Comparators	128 - 130	Destructive Film Thickness Measurement	219
Color Control of Liquids	127 - 135	Dew Point Meter	264
Color Differences	81	Dies for DIN EN ISO impact tester	232
Color instrumentation	82	Dies for impact testers	233, 234, 236
Color instruments, handheld	84 - 95, 105 - 117	Digital Cone and Plate Viscometers	290 - 292
Color instruments, laboratory	97 - 98	Digital Drying Time Recorders	204
Color instruments, portable	84 - 95, 105 - 117		
Color, liquid	127 - 135		
Color Measurement of effect coatings	99 - 104		

Product Index from A–Z

Digital Pocket Microscope	244	Falling Weight Test	228 - 237
Digital Viscometers	278 - 292	Ferrous gages	212 - 216
DIN EN ISO Flow Cup	274	Ferrous Standards, Film Thickness	217
DIN EN ISO Impact Tester	231	Film Application Device for gradient-oven panels	254
DIN EN ISO Impact Tester, accessories	232	Film Applicator, automatic	190 - 191
DIN EN ISO Impact Tester, dies	232	Film Applicators	177 - 187
DIN EN ISO Impact Tester, distance rings	232	Film Casting Knife	181
DIN EN ISO Impact Tester, weights	232	Film Flaws	205
DIN Flow Cup	274	Film Thickness	207 - 220
Dip Cup	271 - 273	Film Thickness Gages	209 - 218
Dip Cup, EZ Series	273	Film Thickness, electronic gages	212 - 216
Dip Cup, S90 Signature Series	273	Film Thickness, non-destructive gages	212 - 216
Dip Cup, Zahn Type	272 - 273	Film Thickness, wet film	209 - 211
Dispersion	202 - 203	Fineness-of-Grind-Gage scraper	202
Display Charts	172	Fineness-of-Grind-Gages	202 - 203
Distance Rings for DIN EN ISO impact tester	232	Flexibility	227 - 241
Distinctness of Image	36	bending testers	240 - 241
DOI	36	cupping testers	238 - 239
Dow Latex Film Applicator	184	impact testers	229 - 237
DPM 300 Digital Pocket Microscope	244	Flow Cup, DIN	274 - 275
Drawdown bars	177 - 180	Flow Cup, DIN EN ISO	274 - 275
Drawdown charts	169- 175	Flow Cups, accessories	276
Drawdown devices	189 - 190	Ford Viscosity Cup	274 - 275
Drawdown holder	174, 189		
Drawdown Plate	174		
Dry Film Thickness, destructive	218 - 220		
Dry Film Thickness, non-destructive	212 - 216		
Drying Time	204	Gage, Fineness-of-Grind	202 - 203
Drying Time Recorder	204	Gages, thickness	209 - 216
accessories	204	Gardner Color	127 - 132
DUALSCOPE MPOR	215	Gardner Delta Color Comparator	130
Dullness	37	empty tubes	130
DUR-O-Test	224	lamp	130
		Gardner Delta Illuminator	130
		Gardner-scrub	151 - 154
		Geometry, 45/0	82
		Geometry, sphere	82
easy-link	34	Glass Filters for LCS III/IV and LCM III/IV	134
Effect Coatings	103	Glass Panel	176
Effect Control	103 - 109	Glass Plate for gradient-oven	254
Elasticity	227 - 241	Gloss and Color	82 - 85
Empty Tubes for Bubble Viscometers	268	Gloss	15 - 30
Empty Tubes for Gardner Delta Color Comparator	130	Gloss and Thickness	19, 216
Empty Tubes for liquid color standards	129	Gloss meters, laboratory	33 - 34
Entris Analytical Balances	194	Gloss meters, portable	17 - 30
esp-10	165	Gloss on films	15
impact tool	165	Gloss Range	16
microscope	165	Gloss Standards	29, 34
standard	165	Gloss units	15
Exhaust Tube for gradient oven	254	gradient-oven	253
		accessories	254
		applications	255 - 258

Product Index from A–Z

exhaust tube	254	Holder for charts	174, 189
glass plate	254	Humidity meter	264
printer	254		
test panel	254		
test panel film application device	254		
test panel marking strips	254		
Graininess	101	Illuminator for Gardner Delta Color Comparator	130
Grind Gages	204 - 205	Image Forming Quality	36
		Impact Test	165, 228 - 237
		Impact Tester, „Coverall“	237
		Impact Tester, DIN EN ISO	231 - 232
		Impact Tester, heavy duty	233
		Impact Tester, light duty	230
		Impact Tester, SPI Modified	234
Handheld color instruments	84 - 95, 105 - 117	Impact Testers	229 - 237
Handheld gloss meters	17 - 30	Impact Tool for esp-10	165
Hardness	221 - 226	Impact Tool for Single Impact Tester	165
Hardness Meter	224	Imperial Cups	200 - 201
Hardness Testers	223 - 225	In-store color matching	96 - 98
Haze	31 - 34	Indentation Hardness	221 - 222, 224
Haze Standard for haze-gloss	34	Indentors	224
Haze, reflection	31, 33	Inmont Gages	210 - 211
Haze, transmission	67 - 68	Interchemical Gages	210 - 211
haze-gloss	33	Interface Cable for BYK-mac i	110
accessories	34	Interface Cable for BYK-mac i COLOR	117
checking standard	34	Interface Cable for haze-gloss	33
haze standard	34	Interface Cable for micro-gloss	23
high gloss standard	34	Interface Cable for micro-TRI-gloss	23
interface cable	34	Interface Cable for micro-TRI-gloss μ	216
mirror gloss standard	34	Interface Cable for spectro2guide	90
sample table	34	Inter-leaf Paper	175
software	34	Iodine Scale	131 - 132
haze-gard i	70 - 75	ISO Density Cup	200 - 201
accessories	74 - 75		
calibration standard	75	Knives, film casting	181
clarity reference standard	75	König Pendulum for Pendulum Hardness Tester	223
cuvette table	74	Krebs type stormer viscometer	289
film holder	74		
haze standard	75		
sample holder	74		
software	74		
transmittance standard	75		
Hazen	127 - 132		
Heat Sink for temp-gard	263	Laboratory color instruments	99 - 100
Heavy Duty Impact Tester	233	Laboratory gloss meters	33 - 34
Hiding Charts	170 - 175	Laminated charts	170, 172
Hiding power tester	188	Laquered charts	170 - 172
High Gloss Standard for haze-gloss	34	LC 2 Conductivity Meter	198
Hoffman Scratch Hardness Tester	161	LCM IV	131
accessories	161	LCS IV	132
large rider	161		
scratching tool	161		
small rider	161		

Product Index from A–Z

Leveling Test Blade, NYPC	186	micro-TRI-gloss	19
Leveling Tester	185 - 186	micro-TRI-gloss μ with thickness	19, 216
Leveling/Sagging Tester	185 - 186	micro-TRI-gloss accessories	23, 27, 30
Levelling	185 - 186	micro-wave-scan	46 - 48
Light Booths	139 - 144	Milkiness	31
Light-Duty Impact Tester	230	Mirror Gloss Standard for haze-gloss	34
Lighting cabinet	139 - 144	Modification Kit for Abrasion Tester	156
Liquid Color	127 - 135	Mottling	55 - 63
Liquid Color Control	127 - 135	Multi-Cut Tools for Cross-Cut Test	220
Liquid Color Measurement	127 - 135	Multiple Clearance Applicators	178 - 181
Liquid Color Meter	131 - 132	Multiple Gap Bars	177 - 180
accessories	133 - 135	Multi-angle color	99 - 120
Liquid Color Meter sample cuvettes	133	Multi-angle color and effect measurement	100 - 102
Liquid Color Meter Thermostat Heater Block	135		
Liquid Color, Quality Control	127 - 135	Narrow Angle Scattering	68
Liquid Color Spectrophotometer	131 - 132	Non-destructive Film Thickness gages	212 - 216
Liquid Color Standards	128 - 129	Non-ferrous gages	212 - 216
Liquid Color Theory	127	Non-ferrous Standards, Film Thickness	217
Liquid Color, Visual Color Comparison	128 - 130	NYPC Leveling Test Blade	186
Magnetic thickness gages	212 - 216	Oils, viscosity	293 - 295
Magnifier for Cross-Cut Tester	160	Online Cable spectro2guide	90
Mandrel bending testers	240 - 241	Opacity Charts	170 - 171
Mandrel set	240	Opacity-Display Charts	172
Mar Resistance Test	162	Opacity Measurement	171
Mar Tester	162	Orange Peel	35 - 53
Marking Strips for gradient oven panels	254	Orifices for Viscosity Cups	276
Measurement of Effect Coatings	100	Oven	250 - 258
Measurement of Appearance, 2nd Edition	242	Oven temperature recorders	259 - 262
Measuring Cell, Conductivity	198		
Measuring geometry, color	82		
Mechanical Cupping Tester	238		
Metallic Coatings	99		
Metallic Color	99 - 125	Pad for Abrasion Tester	156
Metallic Color Theory	99 - 103	Paint and Coating Testing Manual	242
micro-gloss	17 - 30	Paint Inspection Gage	218
accessories	23 - 30	Paint Test Charts	169 - 176
calibration holder	27	Panel, glass	176
checking standard	27	Panels, paper	169 - 175
interface cable	25	Panels for Abrasion Tester	156, 176
software	18, 23, 28	Parallel Grove Adhesion Test	159 - 160
micro-gloss S family	20	Pencil Hardness Tester	225
micro-gloss standards	29, 30	Pencils for hardness test	225
Microscope, Digital Pocket	244	Pendulum Hardness	221 - 223
Microscope for Buchholz Indentation Tester	224	Pendulum Hardness Tester	223
Microscope for Cupping Tester	239	accessories	223
Microscope for esp-10	165	König Pendulum	223
Microscope for Single Impact Tester	165	Persoz Pendulum	223
Microscopes	243 - 246	Penetration Charts	171

Product Index from A–Z

Penopac Charts	171	Scattering	67 - 68
Permeability Cups	205	Scrape Adhesion	162
Pfund Cryptometer	188	Scrape Adhesion and Mar Tester	162
Plain White Charts	173	Scraper for Fineness-of-Grind-Gage	202
Plastic Wet Film Thickness Gage	209	Scratch Hardness	221 - 222, 224
Plate electrode, Conductivity	198	Scratching tool for Hoffman Scratch Hardness Tester	161
Plate holder	174	Scrub Test Panel	176
Pocket Goniometer PGX+	247	See-through Quality	68
Polyester film	176	Sharpness	36, 38 - 39
Portable color instruments	84 - 95, 105 - 117	Shims	214, 217
Portable gloss meters	17 - 30	Single Impact Test	165
POS (Point-of-Sale) Spectrophotometers	96 - 98	Single Impact Tester	165
PosiTest	163 - 164	impact tool	165
Pull-off adhesion tester	163 - 164	microscope	165
Precision Microscope for Buchholz Indentation Tester	224, 246	smart-lab	124 - 125
Printer for gradient-oven	254	smart-process	51 - 53, 61 - 63, 121 - 123
Probes for temp-gard	263	Software easy-link	34
Protective cap for BYK-mac	109	Software for BYK-mac	51 - 53, 120, 121 - 125
Publications	242	Software for byko-test 8500	214
Pull-off Adhesion Testers	163 - 164	Software for byko-test MPOR	215
accessories	164	Software for Cone and Plate Viscometers	292
dollies	164	Software for Digital Viscometers	292
Pull-off gages	164	Software for In-store color matching	98
Pull-off Test	157	Software for micro-gloss	24
Pump	189	Software for micro-TRI-gloss μ	24
Punch for impact testers	233 - 236	Software for oven temperature recorders	260
Pycnometer	200 - 201	Software for temp-gard	260
		Software temp-chart pro	260
		Solid Color	77 - 95
		Sparkle	101 - 103
		Specific gravity cups	199 - 200
Rating	38	spectro2guide	83 - 95
Recorder, drying time	204	accessories	92 - 95
Reflection	15	protective cap	90
Reflectometer	15	software smart-lab	86 - 87
Rotational Viscometers	278 - 282	software smart-process	88 - 89
		USB-Serial cable	90
		spectro-guide S	86
		Spectrophotometer	77 - 125
Sag and Leveling Test Charts	175	Specular excluded, spex	69
Sag and Leveling Tester	185	Specular gloss	15
Sag and Leveling Meter	185, 187	Specular included, spin	69
Sagging Tester	185 - 186	Specular reflection	15
Sagging Test Procedure	185	Spex, specular excluded	69
Sample Cuvettes for LCM IV	133	Sphere geometry	69
Sample Cuvettes for LCS IV	133	SPI Modified Impact Tester	234
Sample Cuvettes for Liquid Color Meter	133	Spin, specular included	69
Sample Cuvettes for Liquid Color Spectrophotometer	133	Spindles for Cone and Plate Viscometers	291
Sample Table for haze-gloss	34	Spindles for viscometers	284 - 287, 291
Sartorius Balances	194 - 197	Spray Monitors	175
Scales	194 - 197	Spreading Rate Charts	172

Product Index from A–Z

Square Drawdown Bars	180	Tube electrode, Conductivity	198
Standard Oils	293 - 295	Tube Holder for Bubble Viscometers	267
Standards addista	134	Tubes for byko-spectra	140 - 144
Standards for esp 10	165	Two-Channel Wet Abrasion Scrub Tester	149 - 156
Standards for micro-gloss	30	Uncoated Test Charts	174
Stands for Viscosity Cups	276	Unlaquered Charts	174
Step gage	211	Unsealed Charts	174
Step Gap Film Applicator	184	USB-cable	25, 110, 117, 263
Stereo Microscope for cupping tester	239		
Stormer Type Viscometer	289		
Structure Spectrum	37		
		Vacuum Plate	189
		Vacuum Pump	189
Tape Adhesion Test	157 - 158	Verification Kit for LCS III - IV and LCS III - IV	134
Tape for Cross Cut	160	Viscometers, bubble	267 - 269
temp-chart <i>pro</i> software	260	Viscometer spindles	284 - 287
Temperature	248 - 264	Viscometer software	283
temp-gard	259, 261 - 262	Viscometers	267 - 290
temp-gard <i>basic</i>	262	accessories	269, 276, 284 - 287, 291
temp-gard <i>dual</i>	261	Viscosity	265 - 295
temp-gard <i>pro</i>	259	Viscosity Cup, Ford	274
accessories	263	Viscosity Cups	270 - 275
datalogger	263	accessories	276
heat sink	263	orifices	276
probes	263	stands	276
thermal barrier	263	Viscosity, oils	293 - 295
Temperature, oven recorders	259 - 262	Visual Color Comparison	137 - 144
Tension	38	Visual Color Comparison, liquids	128 - 130
Test Charts	169 - 176		
Test Charts, Sag&Leveling	175	wave-scan II	43 - 45
Test Charts Uncoated	174	accessories	45
Test Panels for gradient-oven	254	wave-scan dual	39 - 42
Tester, impact	229 - 237	accessories	42
Testers, Hardness	223 - 226	docking station	42
Texture	35	checking tile	42
Thermal Barrier for temp-gard	263	software	42, 61 - 63
Thermostat Heater Block	135	Waviness	14, 35 - 53
Thickness and Gloss	19, 216	wave-scan ROBOTIC	49 - 50
Thickness calibration standards	214, 216	accessories	50
Thickness gages, byko-test	212 - 214	checking tile	50
electronic	212 - 216	software	50, 51 - 53
wet film	209 - 211	Weighing	193 - 197
Thickness, dry film gages	212 - 219	Weight per Gallon Cups	200 - 201
Tolerances, color	81	Weights, DIN EN ISO impact tester	232
Total Appearance	39	Wet Abrasion Scrub Tester	150 - 156
Total Transmission	67	accessories	156
Transmission Color	131	Wet film preparation	167
Transmission Haze	67		
Transmittance	67		
Transparency	67 - 75		

Product Index from A–Z

Wet Film Thickness	207 - 211
Wet Film Thickness Gages	209 - 211
Wet Hiding Power Testing	188
Wet Look	36
Wet Scrub Testers	149 - 156
Wide Angle Scattering	68
Wire Applicators	182 - 183
Wire Bars	182 - 183
Wireless Sensor	214
Wire-wound rods	182 - 183
Wolf-Wilburn Pencil Hardness Tester	225
Zahn Type Dip Cup	272 - 273

Standard Index from A–Z

ANSI Z124.1.2	Abrasion	154 - 155	ASTM D 1545	Viscosity	267 - 269
			ASTM D 156	Color Comparison of Liquids	131 - 132
AOC Method Ka 6-63			ASTM D 1653	Permeability	233
	Viscosity	267, 269	ASTM D 1709	Impact Test	229
			ASTM D 1725	Viscosity	267, 269
AOCS Method BS 684ly/Lr			ASTM D 1729	Visual Color Evaluation	141 - 142
	Color Comparison of Liquids	132	ASTM D 1737	Bend Test	241
			ASTM D 1792	Abrasion	150, 151 - 154
AOCS Method Cc 13e			ASTM D 1925	Color Comparison of Liquids	132
	Color Comparison of Liquids	132	ASTM D 2196	Viscosity	280 - 282
			ASTM D 2197	Scrape Adhesion	162
AOCS Method Tdla-64T			ASTM D 2198	Abrasion	150, 151 - 154
	Color Comparison of Liquids	128, 130	ASTM D 2244	Color measurement	90, 97, 109, 116, 119
			ASTM D 2248	Scrape Adhesion	162
			ASTM D 2454	Scrape Adhesion	162
ASTM B 499	Film Thickness	19, 212 - 216	ASTM D 2457	Gloss measurement	16, 22, 23, 25, 33, 90
			ASTM D 2486	Abrasion	150 - 156
ASTM C 346	Gloss measurement	16, 22	ASTM D 2486	Application	176, 184
			ASTM D 2794	Impact Test	232 - 235
ASTM D 848	Color Comparison of Liquids	132	ASTM D 2801	Application	185
ASTM D 1003	Transparency measurement	69, 70, 73	ASTM D 2805	Application	170, 172, 176
ASTM D 1044	Transparency measurement	73	ASTM D 2805	Density	199
ASTM D 1045	Color Comparison of Liquids	131 - 132	ASTM D 3002	Cross-Cut Test	158 - 159
ASTM D 1084	Viscosity	272	ASTM D 3002	Film Thickness	218
ASTM D 1131	Viscosity	267, 269	ASTM D 3029	Impact Test	233 - 234
ASTM D 1186	Film Thickness	212, 213	ASTM D 3206	Abrasion	150, 151 - 154
ASTM D 1200	Viscosity	274	ASTM D 3207	Abrasion	150, 151 - 154
ASTM D 1209	Color Comparison of Liquids	131 - 132	ASTM D 3258	Application	177, 184
ASTM D 1210	Dispersion	202	ASTM D 3276	Temperature	264
ASTM D 1212	Film Thickness	210	ASTM D 3281	Impact Test	237
ASTM D 1316	Dispersion	202	ASTM D 333	Density	199
ASTM D 1400	Film Thickness	19, 212 - 216	ASTM D 333	Dispersion	202
ASTM D 1475	Density	200	ASTM D 333	Viscosity	274
ASTM D 1500	Color Comparison of Liquids	131 - 132	ASTM D 3359	Cross-Cut Test	158 - 159
ASTM D 1544	Color Comparison of Liquids	128 - 132	ASTM D 3359	Film Thickness	218

Standard Index from A–Z

ASTM D 3363	Hardness	225, 226	ASTM D 823-53	Application	181
ASTM D 344	Application	169 - 170, 172			
ASTM D 3450	Abrasion	150 - 151, 153 - 156	ASTM E 1164	Color measurement	90, 97, 109, 116, 119
ASTM D 3450	Application	176	ASTM E 2194	Color measurement	109, 116, 119
ASTM D 365	Viscosity	274	ASTM E 308	Color measurement	90, 97, 109,
ASTM D 3679	Gloss measurement	23			116, 119, 132
ASTM D 3730	Application	187	ASTM E 430	Haze measurement	33
ASTM D 4062	Application	186	ASTM Z 8741	Gloss measurement	23
ASTM D 4212	Viscosity	272	ASTM Method B	Cross-Cut Test	159
ASTM D 4213	Abrasion	150 - 156			
ASTM D 4213	Application	176	BS 3900	Cupping Test	238
ASTM D 4226	Impact Test	233 - 235		Viscosity	290
ASTM D 4287	Viscosity	290	BS 3900 - E19	Hardness	225
ASTM D 4366	Pendulum Hardness Test	223	BS 3900 (C5)	Film Thickness	212 - 215
ASTM D 4400	Application	175, 187	BS 3900 A 19	Density	199
ASTM D 4488	Abrasion	150, 151 - 154	BS 5350	Viscosity	280 - 282
ASTM D 4541	Pull-Off Adhesion	163	BS 5411 (3, 11)	Film Thickness	212 - 215
ASTM D 4828	Abrasion	150 - 151, 153 - 156	BS 6075	Viscosity	280 - 282
ASTM D 5125	Viscosity	274	BS 7079-B4	Temperature	296
ASTM D 5178	Scrape Adhesion	162			
ASTM D 522	Bend Test	240 - 241	Canadian Government Specification 26-GP-3a		
ASTM D 523	Gloss measurement	16, 19, 25, 33, 90, 216		Abrasion	150
ASTM D 5368	Color Comparison of Liquids	132			
ASTM D 5420	Impact Test	233 - 234	Commonwealth of Pennsylvania Specification W-4		
ASTM D 562	Viscosity	289		Abrasion	150
ASTM D 5682	Conductivity	198			
ASTM D 5895	Drying Time	204	DIN 927-3	Adhesion	159
ASTM D 5946	Surface Tension	247	DIN 11664	Color measurement	90
ASTM D 6736	Abrasion	150, 151 - 154			
ASTM D 7091	Film Thickness	212 - 215	DIN 5033	Color measurement	90, 97, 109,
ASTM D 7234	Pull-Off Adhesion	163			116, 119, 132
ASTM D 7395	Viscosity	291	DIN 5036	Color measurement	90, 97, 109, 116, 119
ASTM D 724	Surface Tension	247	DIN 50981	Film Thickness	212 - 215
ASTM D 816	Viscosity	272	DIN 50984	Film Thickness	212 - 215
ASTM D 823	Application	177, 178, 184, 190-191	DIN 50986	Film Thickness	218

Standard Index from A–Z

DIN 53151	Film Thickness	218	ECE 43	Abrasion	155 - 156
DIN 53166	Cupping Test	238			
DIN 53211 (withdrawn in October 1996)			Erichsen Cupping	Cupping Test	239
	Viscosity	274			
DIN 53217	Density	199	Fed Spec:		
DIN 53232	Cupping Test	238	PD-220A	Application	177
DIN 53778 (withdrawn in August 2007)			TT-E-508A	Application	177
	Abrasion	149, 150 - 156	TT-P	Application	184
DIN 55656	Hardness	224	TT-P-29	Application	177
DIN 55667	Conductivity	198			
DIN 6162	Color Comparison of Liquids	131 - 132	FTMS 141a:	150, 162, 177, 178, 181, 185, 202, 267, 269	
DIN 6174	Color measurement	90, 97, 109, 116, 119, 132	Method 2161	Application	178, 181
DIN 6175-2	Color measurement	109, 116, 119	Method 2162	Application	178, 181
DIN 67530	Gloss measurement	16, 19, 25, 33, 90, 216	Method 4255	Application	178, 181
			Method 4272	Viscosity	267, 269
			Method 4411.1	Dispersion	202
DIN EN 13300	Abrasion	149, 150, 151 - 156	Method 4494	Application	185
DIN EN 13523-4:2001-12			Method 6141	Abrasion	150
	Hardness	225	Method 6142	Abrasion	150
DIN EN 14022	Drying Time	204	Method 6226	Application	178
DIN EN 53778	Abrasion	150, 155	Method 6266	Application	181
			Method 6303.1	Scrape Adhesion	162
DIN EN ISO 11664					
	Color measurement	90, 97, 109, 116, 119			
DIN EN ISO 20567-2			General Electric Company Specification F50TF7-S1		
	Adhesion	165		Scrape Adhesion	162
			GE Aircraft Engine Group Spec. E50TF61-S1		
				Scratch Hardness	161
DTMS 141a:					
Method 2012	Bend Test	240			
Method 6051	Bend Test	240			
Method 6221	Bend Test	240	ISO 11998	Abrasion	149, 150 - 156
Method 6223	Bend Test	240	ISO 11998	Application	176, 191
			ISO 13468	Transparency measurement	69 - 70, 73
ECCA T	Hardness	225	ISO 13803	Haze measurement	33
			ISO 14782	Transparency measurement	73

Standard Index from A–Z

ISO 15091	Conductivity	198	ISO 7765-1	Impact Test	229
ISO 15184	Hardness	225	ISO 7783-2	Permeability	205
ISO 1519	Bend Test	240	ISO 8502-4	Temperature	264
ISO 1520	Cupping Test	238 - 239	ISO 9117-4	Drying Time	204
ISO 1522	Pendulum Hardness Test	223			
ISO 1524	Dispersion	202	JAN-P-630	Application	177
ISO 15989	Surface Tension	247	JAN-P-700	Application	177
ISO 16276-1	Pull-Off Adhesion	163			
ISO 1652	Viscosity	280 - 282	JIS B 7729	Cupping Test	238
ISO 19840	Film Thickness	213	JIS K 5600-5-2	Cupping Test	238
ISO 2049	Color Comparison of Liquids	131 - 132	JIS Z 8741	Gloss measurement	16, 22, 25
	Film Thickness	19			
ISO 2360	Film Thickness	19, 212 - 216	Master Painter Institute MPI 138		
ISO 2409	Cross-Cut Test	158 - 159		Abrasion	150, 154
ISO 2409	Film Thickness	218			
ISO 2431	Viscosity	274	Military Specification:		
ISO 2555	Viscosity	280 - 282	MIL-P-13341	Application	177
ISO 27608	Color Comparison of Liquids	132	MIL-P-7788A	Scrape Adhesion	162
ISO 2808	Film Thickness	19, 210, 212 - 216	Naval Lab Specification WS12858 Part 4.5.5		
ISO 2811	Density	199		Scratch Hardness	161
ISO 2813	Gloss measurement	16, 19, 25, 33, 90, 216			
ISO 2815	Film Thickness, Hardness	218, 224	NCCA II-13	Film Thickness	218
ISO 2884	Viscosity	290 - 291	NCCA X-1	Film Thickness	218
ISO 3668 (accessory required)					
	Visual Color Evaluation, Lightbooth	141-142, 144	New York Society for Paint Technology		
			"Official Digest" No. 44 Vol. 32, No. 430, p. 1435		
ISO 3900	Viscosity	291		Viscosity	186
ISO 4624	Pull-Off Adhesion	163			
ISO 4630	Color Comparison of Liquids	128 - 132	Rock Island Arsenal Specification RIX-268		
ISO 6271	Color Comparison of Liquids	131 - 132		Abrasion	150
ISO 6272-1	Impact Test	231 - 232			
ISO 6272-2	Impact Test	233			
ISO 6504-3	Application	170, 172	SAE J 1545	Color measurement	109, 116, 119
ISO 6860	Bend Test	241			
ISO 7668	Gloss measurement	16, 19, 25, 90			

Standard Index from A–Z

Tappi T 458 Surface Tension 247

Tappi T 480 Gloss measurement 16, 21

„US Federal Specification:

P-C-431a, P-D-220A, P-R-201b, P-W-155,

T-1279D, TT-P-18, TT-P-22, TT-P-23a,

TT-P-26a, TT-P-29B, TT-P-30, TT-P-47a,

TT-P-51d, TT-P-88a, TT-P-508”

Abrasion 150

„US Military Specification:

MIL-C-3004, MIL-C-46057, MIL-E-11237,

MIL-P-13340A, MIL-P-15422B”

Abrasion 150, 154

US Navy Specification 512C20C

Abrasion 150

VTLA 003 Item 9 Film Thickness 218



Touch the color with our new spectro2guide:

There it is in black and white: The new spectro2guide has arrived. The revolution in color management.



Upfront design. Color touchscreen. Camera preview. Auto calibration. Gloss. Fluorescence. Digital standard...

www.touchthecolor.com

General Terms and Conditions of Sale and Delivery

of BYK-Gardner GmbH (BYK-Gardner) (AVLB 2014/E)

1. GENERAL

- 1.1 The General Terms and Conditions of Sale and Delivery of BYK-Gardner shall apply only in relation to customers which are enterprises in terms of § 14 of the Civil Code (BGB) of the Federal Republic of Germany (hereinafter called "Customer").
- 1.2 In the event that BYK-Gardner's General Terms and Conditions of Sale and Delivery are introduced into a transaction with the Customer, such General Terms and Conditions of Sale and Delivery shall also apply to all further transactions between the Customer and BYK-Gardner unless agreed otherwise in writing.
- 1.3 BYK-Gardner's General Terms and Conditions of Sale and Delivery shall apply exclusively. Any conditions of the Customer which are at variance hereto or which conflict with BYK-Gardner's General Terms and Conditions of Sale and Delivery shall only apply if expressly accepted by BYK-Gardner in writing.
- 1.4 In the event that future technical developments result in changes to the goods after the conclusion of the contract, BYK-Gardner is entitled to deliver the technically altered goods. BYK-Gardner is entitled to deviate from illustrations, drawings, descriptions, colours and dimensions, weight, quality and other details, to the extent that such is reasonable for the Customer taking into account the interests of both parties.
- 1.5 BYK-Gardner is entitled to make partial deliveries and to claim separate payment in respect thereof.

2. OFFERS, ORDERS, CHARACTERISTICS OF GOODS

- 2.1 BYK-Gardner's offers are subject to change and are non-binding unless expressly stated otherwise. Such offers are merely an invitation for the Customer to submit a binding order on this basis. A contract will be formed, also in relation to ongoing business transactions, only if the Customer's order is confirmed by BYK-Gardner in writing (including per fax or e-mail) or, if the goods are delivered. BYK-Gardner's order confirmation shall determine the conditions of the contract. In case of immediate delivery BYK-Gardner's order confirmation may be replaced by an invoice.
- 2.2 The obligation to deliver an item only the category of which has been defined shall not encompass the assumption of a procurement risk. BYK-Gardner shall not be deemed to have granted a guaranty unless BYK-Gardner has specified a guaranteed property in writing.
- 2.3 In case of the electronic transmission of an order, the provisions of § 312e section 1, sentence 1, nos. 1 to 3 Civil Code (BGB) (Duties in Electronic Transactions) are hereby excluded. BYK-Gardner shall not be obliged to confirm the receipt of any order by electronic means. Any e-mails received by BYK-Gardner on business days between 0:00 and 16:00 h shall be deemed to have been received as of 16:00 h unless earlier receipt can be proven. E-mails received by BYK-Gardner between 16:01 and 23:59 h shall be deemed to have been received at 16:00 h on the next business day, unless earlier receipt can be proven.

3. PAYMENT CONDITIONS, SECURITY

- 3.1 Unless otherwise agreed, invoiced amounts are due for payment without any deductions within 30 days after the date of invoice. In case payment is received within 14 days after the date of invoice, BYK-Gardner grants a deduction of 2%. Payments shall be deemed settled as soon as the payment in Euro has been credited on one of BYK-Gardner's bank accounts. Any further expenses shall be borne by the Customer. In case of goods being exported, any costs related from the transfer or payments of moneys shall be borne by the Customer to the extent that such arise in the country of the Customer. If payment is not made within the stipulated period, it shall be deemed to be in arrears without previous notice thereof.
- 3.2 Any acceptance of an order and the performance of delivery may be made subject to requirements of security deposit or prepayment. BYK-Gardner is also entitled to demand payment concurrently with the delivery of the goods.
- 3.3 In the event that there is any substantial deterioration in the financial situation of the Customer after concluding the contract, such as by way of filing for insolvency proceedings by the Customer, the commencement of insolvency proceedings, an application for a declaration of insolvency or an arrest warrant or, if there is a cessation of payment or similar, which is not based on any right of retention or other rights, BYK-Gardner may, in addition to BYK-Gardner's rights under Art. 3.2, withdraw from the contract at any time.

- 3.4 Any rights of retention or set-off on the part of the Customer shall only exist in relation to those counterclaims which are undisputed or have been determined by final legal judgement unless the counterclaim relates to a breach of a substantial contractual duty (for definition see section 9.1) on BYK-Gardner's part. Any rights of retention may be exercised by the Customer, only if its counterclaim arises from the same contractual relationship.

4. DELIVERIES AND SHIPMENTS

- 4.1 All binding delivery dates and terms shall require an express written agreement in order to be valid. If non-binding or approximate delivery dates or terms have been specified, BYK-Gardner will use their best efforts to comply with these specifications. Any unilateral requirements stipulated by the Customer shall not be binding on BYK-Gardner unless BYK-Gardner expressly agreed to their validity in writing. Transactions for fixed delivery dates must expressly be designated as such and confirmed by BYK-Gardner in writing.
- 4.2 In the event that BYK-Gardner does not receive any deliveries or services from its subcontractors, or does not receive them properly or in time, for reasons beyond BYK-Gardner's control and despite a reasonable stock being maintained, or in case of any event of force majeure, BYK-Gardner shall inform its Customers timely in writing or in text form. In such case, BYK-Gardner is entitled to delay delivery for the period of the hindrance or to withdraw from the contract in whole or in part in relation to the non-performed part provided that BYK-Gardner met its obligation to inform its Customers and BYK-Gardner has not assumed any risk of procurement. Force majeure includes strikes, lock-outs, actions of authorities, scarcity of energy and raw materials, legal national and international regulations regarding embargo, fight against terrorism or any other regulations, transport difficulties which are not culpably caused by BYK-Gardner, any hindrances to operations which are not culpably caused by BYK-Gardner, for example, as a result of fire, water and machine damage; and any other hindrances which in objective terms have not been culpably caused by BYK-Gardner. In the event that a delivery date or delivery deadline is agreed in a binding manner and as a result of any event under this section 4.2 such agreed delivery date or delivery deadline is not met, the Customer may, after the expiry of a subsequent further reasonable deadline, withdraw from the contract with respect to the non-performed part of such contract, if it would be objectively unreasonable for the Customer to continue to be bound by such a contract. Any further rights to claim on the part of the Customer are excluded in such case.

In the event that the prevention should continue for more than six months or should the delivery become impossible, both parties are entitled to rescind the contract.

- 4.3 Any claims for damages due to delays in delivery shall be limited to a maximum amount of 0.5 % of the net delivery price for the goods delayed per completed week of delay, but totalling no more than a maximum of 5 % of the net delivery price. In case such delay relates to a wilful act or gross negligence or a breach of a substantial contractual duty (for definition see section 9.1), the statutory liability shall apply, however such liability shall be limited to the foreseeable damage in the event of a negligent breach of a substantial contractual duty.
- 4.4 If a Customer sets a reasonable subsequent deadline after a delay in delivery and such deadline expires without performance, the Customer may withdraw from the contract; the Customer shall be entitled to claim damages due to non-performance to the amount of the foreseeable damage only if such non-performance relates to a wilful act or gross negligence or is a breach of a substantial contractual duty (for definition see section 9.1); in all other cases any liability for damages shall be limited to 50 % of the damage incurred.
- 4.5 The limitations of liability in accordance with sections 4.3 and 4.4 shall not apply in so far as a commercial contract where time is of the essence is agreed; the same applies if the Customer may claim that as the result of the delay for which BYK-Gardner is responsible, an immediate claim for damages should apply instead of performance (§281, section 2 Civil Code (BGB)).
- 4.6 BYK-Gardner shall not be in default delay for as long as the Customer is in default of performance of any obligations it may have towards BYK-Gardner, even if resulting from other contracts.
- 4.7 Unless agreed otherwise, any loading and dispatching takes place on an uninsured basis at the risk of the Customer ex works, i.e. EXW Geretsried according to the Incoterms in the latest version.
- 4.8 BYK-Gardner shall determine the means of transport and the transport route. BYK-Gardner will, however, attempt to take into account the Customer's

General Terms and Conditions of Sale and Delivery

of BYK-Gardner GmbH (BYK-Gardner) (AVLB 2014/E)

preferences in regard to means and route of transportation; however, any additional costs resulting therefrom – also in relation to agreed free freight delivery – shall be borne by the Customer.

5. PRICES

- 5.1 Any orders placed with BYK-Gardner shall be performed at the list prices valid on the delivery date in Euro including packaging. These prices are quoted exclusive of the statutory value-added tax, as amended. Unless agreed otherwise, the contract prices shall be quoted ex works, i.e. EXW Geretsried according to the Incoterms in the latest version.
- 5.2 BYK-Gardner is entitled to reasonably increase prices unilaterally (§ 315 Civil Code (BGB)) in case of any increase in material procurement or production costs, taxes, wage or salary or social security costs as well as energy costs and costs for environmental protection provided that the time between the concluding of the contract and delivery is greater than four months. Any increase in terms of the above is not possible in so far as the increase of costs of any of the above named factors is set off by a decrease in costs of any of the above factors in relation to the total cost burden for the delivery.

6. RETENTION OF TITLE

- 6.1 BYK-Gardner reserves the title of ownership to all goods supplied by BYK-Gardner (hereinafter referred to generally as "retention of title goods"), until all claims of BYK-Gardner arising from the business connection with the Customer, including any future claims from contracts concluded at a later time, have been settled. This shall also apply to any balance in favour of BYK-Gardner, if any specific individual claim or all claims by BYK-Gardner are included in a current invoice (current account) and a balance is drawn.
- 6.2 The Customer shall insure all retention of title goods adequately in particular against fire, water and theft. Any claims against an insurer arising out of a case of damage affecting retention of title goods shall hereby be deemed to have already been assigned to BYK-Gardner to the amount of the value of the retention of title goods.
- 6.3 The Customer is entitled to resell the delivered goods in the normal course of business. Any other form of disposal by the Customer, and in particular any pledging or granting of any security rights shall not be permitted. If the retention of title goods are not paid for by a third party immediately during the course of resale, the Customer shall sell such only subject to retention of title. Any entitlement to resell retention of title goods shall be extinguished automatically, if the Customer ceases to make payment or is in default with any payment in relation to BYK-Gardner. The same shall apply correspondingly if the Customer is part of a group of companies and/or if one of the circumstances described in the above sentence occurs in relation to the parent company or a holding company of the Customer.
- 6.4 The Customer hereby assigns to BYK-Gardner in advance all claims, including any securities and supplementary rights, which it is entitled against any final purchasers or third parties as a result of or in connection with the resale of retention of title goods. The Customer shall not enter into any agreement with its customers which exclude or limit BYK-Gardner's rights in any manner whatsoever or which render void the advanced assignment of claims. In case of the sale of retention of title goods together with other items, the claim against the third party purchaser shall be deemed to have been assigned to BYK-Gardner to the amount of the delivery price agreed between BYK-Gardner and the Customer, to the extent that the individual amounts attributable to the relevant goods cannot be determined from the invoice.
- 6.5 The Customer shall remain entitled to collect any claims which have been assigned to BYK-Gardner until such right is duly revoked by BYK-Gardner to which revocation BYK-Gardner is entitled at any time. Upon request, the Customer shall provide BYK-Gardner with the information and documentation necessary to collect any assigned claims and, insofar as BYK-Gardner does not do so itself, the Customer shall inform its customers immediately about the assignment of the claims to BYK-Gardner.
- 6.6 If the Customer includes any claims from resale of retention of title goods in a current account relationship with its customers, it hereby assigns to BYK-Gardner in advance any recognised final balance in its favour which corresponds with the total amount of the claim from the resale of BYK-Gardner's retention of title goods.
- 6.7 If the Customer has already assigned any claims from the resale of goods delivered or to be delivered by BYK-Gardner to a third party, in particular on the basis of non-recourse factoring or recourse factoring or any other agreements, on the basis of which BYK-Gardner's current or future rights of security in

in accordance with this section could be limited, it shall notify BYK-Gardner of such without undue delay. In case of recourse factoring BYK-Gardner is entitled to withdraw from the contract and to demand restitution of any goods already delivered. The same shall apply in case of non-recourse factoring, if the Customer is unable to freely dispose of the purchase price of the claim under the contract with the factor.

- 6.8 In case of any contractual breach, in particularly in case of default in payment, BYK-Gardner is – without BYK-Gardner having to withdraw from the contract beforehand – entitled to recover all retention of title goods; the Customer is in such case automatically obliged to release such goods to the extent that not only a breach of a minor duty has occurred. In order to be able to determine the stock of goods delivered by BYK-Gardner representatives of BYK-Gardner may at any time during the normal hours of business enter the business premises of the Customer. Recovering retention of title goods shall qualify as withdrawal from the contract only if BYK-Gardner declares such expressly in writing or if such is required by the mandatory provisions of law. The Customer shall notify BYK-Gardner without undue delay in writing of any access of third parties to the retention of title goods or claims assigned to BYK-Gardner.
- 6.9 If the value of the securities available to BYK-Gardner under the above provisions exceeds the secured claims in total by more than 10 %, BYK-Gardner shall, if requested by the Customer, release any security at BYK-Gardner's choice to such extent.
- 6.10 From the time of cessation of payment by the Customer or in case of the issuing of an application for insolvency of the Customer, the Customer shall no longer be entitled to sell any retention of title goods. The Customer shall in such case undertake separate storage and labelling of retention of title goods without undue delay and shall further keep for BYK-Gardner on a fiduciary basis any moneys received from assigned claims arising from the delivery of goods.
- 6.11 If the above agreed retention of title is not recognised or is only recognised under certain preconditions under the law of the country into which the goods are delivered, the Customer shall notify BYK-Gardner of such at the latest upon the concluding of the contract. If the laws of such country do not allow for retention of title or an extended retention of title, but would allow BYK-Gardner other rights in similar manner to a retention of title for security purposes, BYK-Gardner hereby declares, that BYK-Gardner shall use such rights in relation to the delivered goods. The Customer shall assist in undertaking all necessary measures (in particular compliance with formalities).

7. RIGHTS OF USE REGARDING SOFTWARE

- 7.1 Any Software which is transferred to the Customer or made available by download represents a copyright work by BYK-Gardner and/or its licensors. All rights of the Software in relation to the Customer appertain exclusively to BYK-Gardner and/or its licensors.
- 7.2 BYK-Gardner transfers to the Customer a simple, non-exclusive, non-sublicensable, and non-transferable right to use the Software exclusively for his own purposes in his company. The Customer is entitled to use the Software as a whole or partly on a data processing instrument. The simultaneous use on several data processing instruments is excluded.
- 7.3 In case the Software is transferred to the Customer together with other goods purchased from BYK-Gardner, the Customer may use the Software only to the extent and for the purpose, necessary for the operation of the goods purchased from BYK-Gardner.
- 7.4 Especially, the Customer shall not copy the Software, except for a back-up copy for security purposes.
- 7.5 The Customer is not entitled to change, to disassemble or to further develop the Software.
- 7.6 Indications regarding the owner of the rights of the Software and of the documentation shall not be removed.
- 7.6 In case goods from BYK-Gardner which contain Software are resold, the above mentioned rights to use and obligations arising from this right are transferred to the buyer.

8. WARRANTY, NOTIFICATION OF DEFECT

- 8.1 The Customer shall immediately inspect the goods delivered upon delivery, where appropriate, for any defects regarding their quantity and quality, by a trial process, and shall notify BYK-Gardner of any defects without delay, but not later than within 7 days upon receipt of the goods; otherwise, the goods shall be deemed to have been approved. BYK-Gardner shall be notified of

General Terms and Conditions of Sale and Delivery

of BYK-Gardner GmbH (BYK-Gardner) (AVLB 2014/E)

any defects not detectable by such an inspection immediately, however, not later than 7 days upon their discovery. Any complaints shall be filed in writing specifying the order data and the invoice and shipping numbers. A complaint not filed in time shall bar the Customer from asserting any claims of non-compliance on grounds of inferior performance. Any hidden defects shall be notified by the Customer immediately after they have become detectable, but not later than within the period of limitation indicated in Article 9.6. Complaints for defects shall always be accompanied by a reasonably detailed description of the defect.

The warranty period is 24 months after delivery to the Customer.

- 8.2 Any notice of defect under section 8.1 must be in writing.
- 8.3 In case the Customer returns the goods within Germany or the EU, the goods shall be sent to BYK-Gardner's registered office in Geretsried if possible in original packaging by delivery prepaid. After completion of the order BYK-Gardner shall return the goods to the Customer by delivery prepaid.

In case of return shipment by airfreight, the goods shall be sent if possible in original packaging to Munich Airport (CPT Incoterms 2010). After repair the goods shall be returned to the Customer's nearest airport (CPT Incoterms 2010). Customs clearance in Customer's country shall be taken over by the Customer.

- 8.4 If justified defects have been notified in time, BYK-Gardner shall at its choice rectify the defect itself or by third parties free of charge or deliver defect-free goods (subsequent performance). In case of any delivery recourse (§§ 478, 479 Civil Code (BGB)), the Customer shall have the right of choice. Before sending back any goods, BYK-Gardner's permission is to be obtained. Any replaced goods shall become the property of BYK-Gardner. If BYK-Gardner does not rectify any defect or does not provide a replacement delivery for the defective goods within a subsequent reasonable deadline set, or if any subsequent performance is not successful (whereby BYK-Gardner is permitted to make two attempts), or if BYK-Gardner refuses to provide subsequent performance or if such is not reasonable for BYK-Gardner, the Customer may in accordance with the provisions of law withdraw from the contract, reduce the price, claim compensation for expenses as well as damages within the terms set out in section 9. Any right to withdraw from the contract or right for a price reduction shall only apply in case of defects which are not insignificant.
- 8.5 BYK-Gardner's liability in accordance with section 9. shall not be affected hereby.
- 8.6 BYK-Gardner warrants that the Software has been developed according to the current state of the art, has been carefully checked and substantially conforms to the applicable product documentation. The warranty does not include the confirmation that the Software answers the Customer's requirements or is compatible with other programs selected by the Customer.

9. LIABILITY, EXCLUSION AND LIMITATION OF LIABILITY

- 9.1 BYK-Gardner shall be generally liable only for any wilful act or gross negligence by BYK-Gardner or its legal representatives or vicarious agents. BYK-Gardner's liability and that of its legal representatives and vicarious agents for minor negligence is excluded only insofar as such does not relate to (1) a breach of a substantial contractual duty, (2) breach of any duty in terms of § 241, section 2 Civil Code (BGB), if it would no longer be reasonable for the Customer to accept BYK-Gardner's performance, (3) any injury to life, personal injury or injury to health, (4) the acceptance of any guarantee for the quality of any performance, for the successful performance or for any risk of procurement, (5) deceit, (6) initial impossibility, (7) claims in accordance with the German Product Liability Act (Produkthaftungsgesetz) or (8) any other cases of mandatory legal liability.

"Substantial contractual duty" is any duty which contractually protects the substantial legal position of the Customer, such being entitled to be protected in terms of the content and purpose of the contract; substantial duties also refer to those contractual duties, which must be performed in order to allow the due performance of the contract itself and the compliance with which the Customer regularly relies on, and may rely on.

- 9.2 To the extent that BYK-Gardner cannot be made liable for intentional breach of obligations and there is no case of injury to life, personal injury or injury to health or any other case of mandatory legal liability, BYK-Gardner shall be only liable for typical and foreseeable damage.
- 9.3 Any liability for indirect damage and consequential damage is hereby excluded insofar as such is not the result of a wilful act or gross negligence or a breach

of a substantial contractual duty (for definition see section 9.1).

- 9.4 Any further liability for damages other than that set out in the above sections shall be – regardless of the legal nature of such – excluded. This shall apply in particular for any claims for damages resulting from fault at the time of the concluding of the contract, due to any other breaches of duties or any claims under torts for compensation for damage in terms of § 823 Civil Code (BGB).
- 9.5 Any exclusions or limitations of a liability in terms of the above sections 9.1 to 9.4 shall apply to the same extent in favour of BYK-Gardner's managers and non-managerial employees as well as its vicarious agents and subcontractors.
- 9.6 Any claims of the Customer for damages arising out of this contractual relationship may be made only within a period of one year from the commencement of the statutory limitation period. The same shall apply for any competing claims arising out of torts as well as any claims for consequential damage. This shall not apply in case of deceit, gross negligence or wilful acts on the part of BYK-Gardner. The limitation period in case of any recourse for delivery in accordance with §§ 478, 479 Civil Code (BGB) shall not be affected.
- 9.7 The above provisions shall not constitute a reversal of the burden of proof.

10. JURISDICTION AND APPLICABLE LAW

- 10.1 The place of jurisdiction for any and all disputes arising out of this contract shall be Munich, Germany.
- 10.2 The law of the Federal Republic of Germany shall apply to the exclusion of the United Nations Convention on Contracts for the International Sale of Goods (CISG).
- 10.3 If any of BYK-Gardner's order confirmations contains a clause from INCOTERMS, the respective applicable provision of INCOTERMS in the latest version shall apply unless otherwise stated in BYK-Gardner's respective order confirmation.

11. SEVERANCE CLAUSE

In the event that individual provisions hereof should be invalid for any other reason than those in §§ 305 – 310 Civil Code (BGB) the remaining provisions shall not be affected. Any invalid provision shall be deemed to have been replaced by a valid substitute provision which most closely reflects the originally intended commercial purpose.

Note:

In accordance with the provisions of the German Federal Data Protection Act (Bundesdatenschutzgesetz) BYK-Gardner must inform the Customer that purchase orders are processed on IT-systems and that data received from the Customer on the basis of the commercial relationship will be electronically recorded and stored. BYK-Gardner does not process any inquiries or orders from persons, companies, organizations or countries that are listed on any national or international official list of sanctions and embargos and will immediately cancel any confirmed orders.

The Customer commits to use the goods exclusively according to the rules and to abide by the valid and applicable European Union regulations regarding international commercial law (dual use, embargo).

All trademarks, logos, illustrations, photos and text included in the catalog are protected by copyright law.

Duplication, distribution, alteration or alternative use is not permitted. Usage of any contents of the BYK-Gardner catalog shall only be allowed upon prior written consent by BYK-Gardner.

The Bluetooth® word mark and logos are registered trademarks owned by Bluetooth SIG, Inc. and any use of such marks by BYK-Gardner is under license. Other trademarks and trade names are those of their respective owners.

Color Matching at Refinish Body Shops

BYK-Gardner color instruments always hit the right color!

Every year new models and new colors are introduced to meet current fashion trends. The statement "Color Sells" shows how important this design criterion is for the purchasing decision. Thus, every year approximately 1000 new colors are added to the existing hundreds of thousands of colors.

This presents a real challenge for the body shop after an accident! In a car body shop it is most important to quickly find the correct color match and to be right on target. The time needed for color matching and material consumption determine the repair cost, which are closely watched by insurance companies nowadays. Not to mention customer complaints, if the color does not match!

Accurate color matching is one of the most difficult tasks when repairing a car finish. As an orientation guide in this "color jungle" car refinish paint makers support body shops with color fan decks and color look-up databases. By entering the auto maker and color code in a look-up database the right color formula could be easily found, if there were not the inevitable color deviations of car bodies made at different plants and add-on parts coming from different suppliers. Therefore, a painter's most important tool is his own "trained eye". Yet, new metallic or pearl finishes with special sparkling effects make it more and more difficult to determine the right color even for very experienced painters, as color is not only changing under different viewing angles, but also under different lighting conditions (sunny sky – cloudy sky).

In order to repaint a car cost efficiently in a short period of time leading car refinish paint makers use new technologies to improve their hit rates: Multi-angle color instruments objectively measure the color to be painted and "smart" database search and correction routines are used to find the right color in seconds. Thus, and most important, life at the body shop will be much easier for everybody.

New measurement technologies make it possible to exactly match any color – in seconds:

- › Clean and polish the paint finish close to the damaged area.
- › Measure the prepared area.
- › Transfer the measurement data to the color search and correction software of the paint maker.
- › The software will find the closest match in a second, adjust the paint formula and automatically transfer the formula to the mixing system.



ma



BYK-Gardner multi-angle color systems are the ideal partner:

Leading car refinish paint makers have selected BYK-Gardner as their preferred supplier for color instruments, as they best meet the needs of a car body repair shop:

- › Robust design
- › Ease-of-use: Just push the operate button to take a reading and save the data
- › Precise color data: Repeatable and without operator influence
- › Long battery life: 3000 readings with regular Alkaline or rechargeable NiMH batteries
- › No lamp change needed: the patented LED technology allows a 10 year lamp warranty
- › Temperature stable readings regardless of the temperature in the body shop: Absolutely repeatable results between 10 °C to 40 °C (60 °F to 100 °F)
- › Repair costs are minimal due to the design and use of the newest technologies in electronic and optical components.

BYK-Gardner's solution has proven itself in real life – painters are enthusiastic about the ease-of-use and reliable readings. The benefits are most evident when trying to match difficult colors. A true “win-win” situation has developed for paint makers as well as the painters at the body shop.

tech



WWW.BYK.COM